

DL 0 607 953 ...
DL 0 607 954 ...

D	4 ... 8
GB	9 ... 13
F	14 ... 18
E	19 ... 23
P	24 ... 28
I	29 ... 34
NL	35 ... 39
DK	40 ... 44
S	45 ... 49
N	50 ... 54
FIN	55 ... 59
GR	60 ... 64
TR	65 ... 69

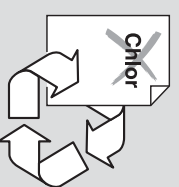

BOSCH

BOSCH



Robert Bosch GmbH
Geschäftsbereich Elektrowerkzeuge
D-70745 Leinfelden-Echterdingen
3 609 929 498 (99.10)
Printed in Germany - Imprimé en Allemagne

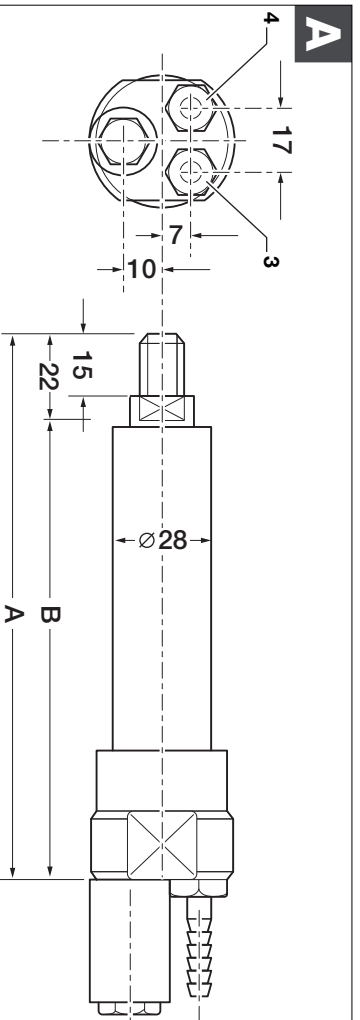
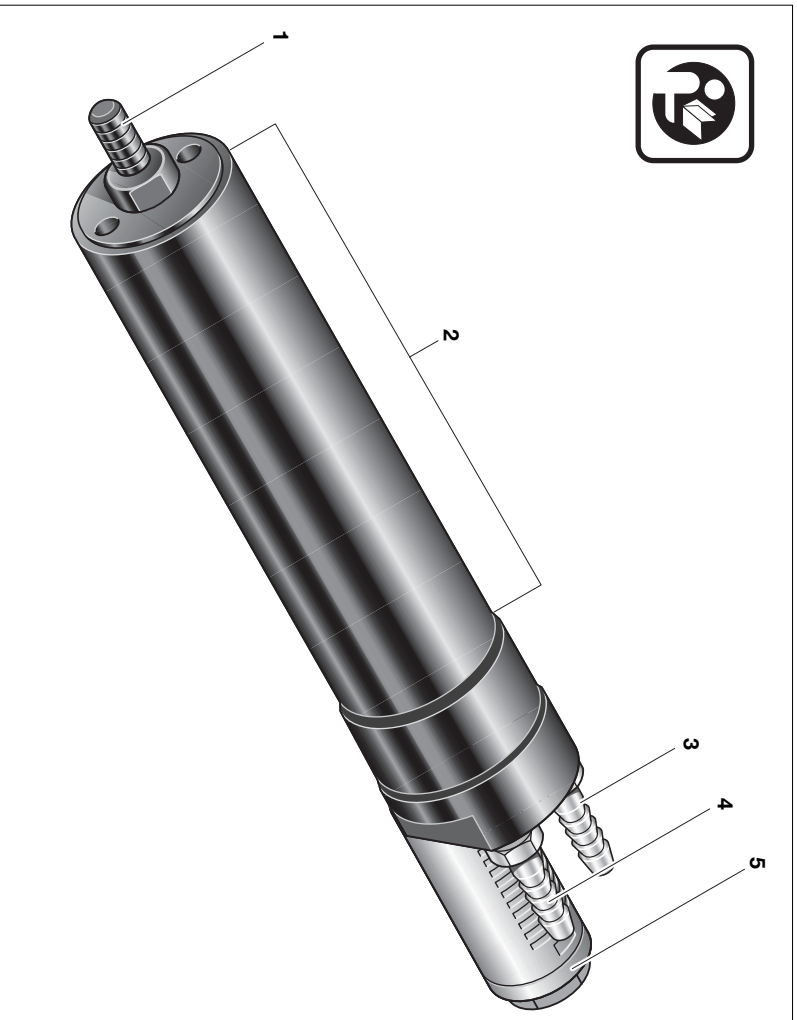

0 607 953 ...		0 607 953 ...		0 607 954 ...			
	A [mm]	B [mm]	A [mm]	B [mm]	A [mm]	B [mm]	
...308	150	128	...314	163	...304	142	120
...309	150	128	...315	163	...305	127	105
...310	150	128	...316	148	...306	155	133
...311	135	113	...317	148	...307	140	118
...312	135	141	...326	150			
...313	163	141					

**Gerätekennwerte**

D

**Druckluft-Einbaumotor 180 W**

Bestellnummer 0 607 953 308	... 309	... 310	... 311	... 312	... 313
Leertaufdrehzahl	[min ⁻¹] 820	1 250	1 700	3 000	5 400	660
Abwürgemoment	[Nm] 8,0	5,3	3,7	2,1	1,1	7,5
Abgabeleistung	[W] 180	180	180	180	180	160
Drehrichtung	↻	↻	↻	↻	↻	↻
Werkzeugaufnahme	3/8"-24 UNF-2A ●	●	●	●	●	●
Nenndruck	[bar/psi] 6,3/90	6,3/90	6,3/90	6,3/90	6,3/90	6,3/90
Schlauchanschluß	G 1/8"	G 1/8"	G 1/8"	G 1/8"	G 1/8"	G 1/8"
Lichte Schlauchweite	[mm] 6	6	6	6	6	6
Luftverbrauch unter Last	[l/s] 6,0	6,0	6,0	6,0	6,0	7,2
Gewicht (ohne Zubehör) ca.	[kg] 0,58	0,58	0,58	0,50	0,50	0,64

Druckluft-Einbaumotor 180 W

Bestellnummer 0 607 953 314	... 315	... 316	... 317	... 326
Leertaufdrehzahl	[min ⁻¹] 1 050	1 400	2 600	4 600	2 000
Abwürgemoment	[Nm] 5,1	3,5	2,0	1,0	3,1
Abgabeleistung	[W] 160	160	160	160	180
Drehrichtung	↻	↻	↻	↻	↻
Werkzeugaufnahme	3/8"-24 UNF-2A ●	●	●	●	●
Nenndruck	[bar/psi] 6,3/90	6,3/90	6,3/90	6,3/90	6,3/90
Schlauchanschluß	G 1/8"	G 1/8"	G 1/8"	G 1/8"	G 1/8"
Lichte Schlauchweite	[mm] 6	6	6	6	6
Luftverbrauch unter Last	[l/s] 7,2	7,2	7,2	7,2	6,0
Gewicht (ohne Zubehör) ca.	[kg] 0,64	0,64	0,56	0,56	0,58

3 609 929 498 • 99.10

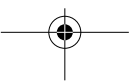
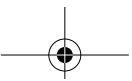
**Druckluft-Einbaumotor 120 W**



Bestellnummer 0 607 954 304	... 305	... 306	... 307
Leertaufdrehzahl	[min ⁻¹] 2 200	4 900	1 850	4 100
Abwürgemoment	[Nm] 2,1	1,0	2,0	0,9
Abgabeleistung	[W] 120	120	100	100
Drehrichtung	↻	↻	↻	↻
Werkzeugaufnahme	3/8"-24 UNF-2A ●	●	●	●
Nenndruck	[bar/psi] 6,3/90	6,3/90	6,3/90	6,3/90
Schlauchanschluß	G 1/8"	G 1/8"	G 1/8"	G 1/8"
Lichte Schlauchweite	[mm] 6	6	6	6
Luftverbrauch unter Last	[l/s] 4,5	4,5	5,0	5,0
Gewicht (ohne Zubehör) ca.	[kg] 0,37	0,32	0,37	0,32

4





Geräteelemente

- 1 Werkzeugaufnahme
- 2 Einspannbereich
- 3 Schlauchanschluß für Rechtslauf 
- 4 Schlauchanschluß für Linkslauf  nur bei Geräten mit 
- 5 Luftaustritt (mit Schalldämpfer*)

* **Zubehör**
Abgebildetes oder beschriebenes Zubehör gehört teilweise nicht zum Lieferumfang.



Zubehör

Schlauchstützen, 3 603 386 002
 Schalldämpfer 3 607 000 016
 Befestigungsflansch 180 W 3 605 700 044
 Befestigungsflansch 120 W 3 605 700 043
 Spezial-Getriebefett 225 ml 3 605 430 009



Zu Ihrer Sicherheit



Gefahrloses Arbeiten mit dem Gerät ist nur möglich, wenn Sie die Bedienungsanleitung und die Sicherheitshinweise vollständig lesen und die darin enthaltenen Anweisungen strikt befolgen.

Zusätzlich muß der Abschnitt Sicherheitshinweise für Druckluftgeräte beachtet werden.
Lassen Sie sich vor dem ersten Gebrauch praktisch einweisen.

- **Unterbrechen Sie die Luftversorgung**
 Unterbrechen Sie die Luftversorgung bei Nichtgebrauch und vor der Wartung des Gerätes sowie vor dem Wechsel von Einsatzwerkzeugen.
- Hände weg von der rotierenden Werkzeugaufnahme sowie dem eingesetzten Werkzeug. Beim Bruch des Einsatzwerkzeugs können wegfliegende Splitter Verletzungen verursachen.
- **Vorsicht bei beengten Arbeitsverhältnissen**
 Aufgrund von Reaktionsmomenten können Verletzungen durch Einklemmen oder Quetschen entstehen.
- **Gerät nicht überlasten.**
 Mit dem angegebenen Nenndruck arbeiten. Sämtliche Armaturen, Verbindungsleitungen und Schläuche müssen dem Druck und der erforderlichen Luftmenge entsprechend ausgelegt sein.



- Verwenden Sie beim Einspannen des Einbaumotors in eine Einspannvorrichtung den Befestigungsflansch, und beachten Sie die Sicherheitshinweise der Einspannvorrichtung.
- Den Einspannbereich des Einbaumotors nicht überlasten.
- Bosch kann nur dann eine einwandfreie Funktion des Gerätes zusichern, wenn Original-Zubehör verwendet wird.

Luftversorgung

Die zugeführte Druckluft muß frei sein von Fremdkörpern und Feuchtigkeit, um das Gerät vor Beschädigung, Verschmutzung und Rostbildung zu schützen.
Die Verwendung einer Druckluft-Wartungseinheit ist notwendig.

Sämtliche Armaturen, Verbindungsleitungen und Schläuche müssen dem Druck und der erforderlichen Luftmenge entsprechend ausgelegt sein.

Verengungen der Zuleitungen z. B. durch Quetschen, Knicken oder Zerrn vermeiden!

Im Zweifelsfall den Druck am Lufttritt bei eingeschaltetem Gerät mit einem Manometer prüfen.

Wartungseinheit

Die Wartungseinheit gewährleistet eine einwandfreie Funktion von Druckluftwerkzeugen.

- Sie besteht aus drei Haupt-Komponenten:
- Filter mit Wasserabscheider,
 - Druckreduzierventil mit Manometer,
 - Nebelöl.

Schmierstoff im Nebelöl: Motorenöl SAE 10/SAE 20.

Kein Petroleum oder Dieselöl verwenden.

Nebelöl so einstellen, daß sich am Luftaustritt ein dünner Schmierfilm bildet.

Bedienungsanleitung der Wartungseinheit beachten.

Vor Inbetriebnahme

Befestigen Sie den Einbaumotor nur im angegebenen Einspannbereich **2**, und nutzen Sie möglichst den gesamten Einspannbereich. Je geringer der Einspannbereich desto größer wirken die Spannkkräfte.

- Den Einspannbereich des Einbaumotors nicht überlasten.

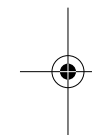



Montage

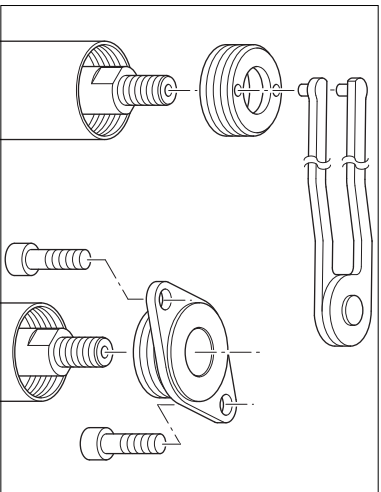

Schrauben Sie den Gewinding mit einem Hakenschlüssel heraus (Linksgewinde) und den Befestigungsflansch ein. Am Befestigungsflansch kann der Einbaumotor mit zwei Schrauben an der Einspannvorrichtung angeschraubt werden.

Typ 0 607 953 308 / ... 309 / ... 310 /

... 311 / ... 312 / ... 326

Typ 0 607 954 304 / ... 305

Rechtslauf:

Zuluftschlauch an Schlauchanschluß **3** anschließen.



Bei hohen Drehmomenten wird eine entsprechend große Gegenhalterkraft benötigt.

Mit einer Einspannvorrichtung im Bereich **2** kann diese Gegenhalterkraft besser aufgenommen werden. Sorgen Sie dafür, daß der Zusatzgriff bzw. die Einspannvorrichtung das Gerät sicher und fest hält.

Typ 0 607 953 313 / ... 314 / ... 315 /

... 316 / ... 317

Typ 0 607 954 306 / ... 307

Rechtslauf:

Zuluftschlauch an Schlauchanschluß **3** anschließen.

Linkslauf:

Zuluftschlauch an Schlauchanschluß **4** anschließen.



Bei hohen Drehmomenten wird eine entsprechend große Gegenhalterkraft benötigt.

Mit einer Einspannvorrichtung im Bereich **2** kann diese Gegenhalterkraft besser aufgenommen werden. Sorgen Sie dafür, daß der Zusatzgriff bzw. die Einspannvorrichtung das Gerät sicher und fest hält.

Drehmoment

Das Drehmoment ist über den Betriebsdruck steuerbar.

Die angegebene Leerlaufdrehzahl stellt sich bei angeschlossenen Schalldämpfer ein. Wird der Schalldämpfer entfernt, muß die Drehzahl überprüft werden. Eine überhöhte Drehzahl ist mit einer Drossel auf die Nenndrehzahl zu reduzieren.

Überhöhte Drehzahlen verursachen unnötigen Lärm und verkürzen die Lebensdauer des Geräts.

Abluft abführen

Nach Entfernen des Schalldämpfers **5** kann durch Anschließen eines Schlauches am Luftaustritt die Abluft abgeführt werden.

Vorteile:

- Geräuschminderung,
- keine Verschmutzung des Arbeitsplatzes durch aufgewirbelten Staub,
- Abluftführung.

Inbetriebnahme

Das Gerät arbeitet optimal bei einem Nenndruck von 6,3 bar (90 psi), gemessen bei laufendem Gerät am Luftaustritt.

Ein-Aus-Schalten

Läuft das Gerät: z.B. nach längerer Ruhezeit, nicht an, Luftversorgung unterbrechen und Werkzeugaufnahme **1** von Hand durchdrehen. Dadurch werden Adhäsionskräfte beseitigt.



Bei einer Unterbrechung der Luftversorgung oder reduziertem Betriebsdruck Gerät ausschalten. Betriebsdruck prüfen und bei optimalem Betriebsdruck erneut starten.

Das Ein- und Ausschalten des Gerätes erfolgt über die Einschaltung bzw. Unterbrechung der Druckluftversorgung.

Arbeitshinweise

Vor allen Arbeiten am Gerät Luftversorgung unterbrechen.

Drehrichtung

Je nach gewünschter Drehrichtung die Luftversorgung an den linken oder rechten Schlauchstützen anschließen.

Plötzlich auftretende Belastungen bewirken einen starken Drehzahlabfall oder den Stillstand, schaden aber nicht dem Motor.

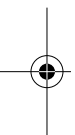
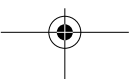
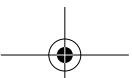



Wartung und Reinigung

Vor allen Arbeiten am Gerät Luftversorgung unterbrechen.

Gerät und Werkzeugaufnahme stets sauberhalten.

Sollte das Gerät trotz sorgfältiger Herstell- und Prüfverfahren einmal ausfallen, ist die Reparatur von einer autorisierten Kundendienststelle für Bosch-Elektrowerkzeuge ausführen zu lassen.

Bei allen Rückfragen und Ersatzteilbestellungen bitte unbedingt die 10stellige Bestellnummer laut Typenschild des Gerätes angeben.

Schmierem

Schmierstoff:
Spezial-Getriebefett
225 ml. 3 605 430 009
Motorendl SAE 10/SAE20



Getriebe erstmals nach ca. 150 Betriebsstunden, dann alle 300 Betriebsstunden mit Waschbenzin auswaschen und mit Spezial-Getriebefett schmieren. Eine autorisierte Bosch-Kundendienststelle führt diese Arbeiten schnell und zuverlässig aus.

Schmier- und Reinigungsmittel umweltgerecht entsorgen. Gesetzliche Vorschriften beachten.

Garantie

Für Bosch-Geräte leisten wir Garantie gemäß den gesetzlichen/länderspezifischen Bestimmungen (Nachweis durch Rechnung oder Lieferschein).

Schäden, die auf natürliche Abnutzung, Überlastung oder unsachgemäße Behandlung zurückzuführen sind, bleiben von der Garantie ausgeschlossen.

Beanstandungen können nur anerkannt werden, wenn Sie das Gerät **unzerlegt** an den Lieferer oder an eine Bosch-Kundendienstwerkstätte für Druckluft- oder Elektrowerkzeuge senden.

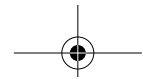

3 609 929 498 • 99.10

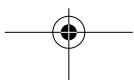

Industriewerkzeug-Partner

Deutschland

Robert Bosch GmbH
Servicezentrum Elektrowerkzeuge
Zur Luhne 2
37589 Kalefeld-Willershausen

☎ Service (01 80) 3 35 54 99
Fax (0 55 53) 20 22 37
☎ Kundenberater (01 80) 3 33 57 99

Österreich

ABE Service GmbH
Jochen-Rindt-Strabe 1
1232 Wien

☎ Service (02 22) 61 03 80
Fax (02 22) 61 03 84 91
☎ Kundenberater (02 22) 7 97 22 30 20

Schweiz

Robert Bosch AG
Kundendienst Elektrowerkzeuge
Industriestrasse 31
8112 Otelfingen

☎ Service (01) 8 47 16 16
☎ Kundenberater: Grüne Nummer (0 800) 55 11 55

Umweltschutz



Rohstoffrückgewinnung statt Müllentsorgung

Gerät, Zubehör und Verpackung sollten einer umweltgerechten Wiederverwertung zugeführt werden.

Diese Anleitung ist aus chlorfrei gefertigtem Recycling-Papier hergestellt.

In Deutschland können nicht mehr gebrauchsfähige Geräte zum Recycling beim Handel abgegeben oder (ausreichend frankiert) direkt eingeschickt werden an:

Bosch-Recycling-Center
D-37589 Kalefeld-Willershausen

Herstellereklärung

Herstellereklärung gemäß 98/37/EG:

Dieses Produkt ist ausschließlich zum Einbau in eine andere Maschine bzw. zum Zusammenbau mit einer anderen Maschine oder anderen Maschinen bestimmt. Die Inbetriebnahme ist solange untersagt, bis die Konformität des Endproduktes mit den Bestimmungen der Richtlinie 98/37/EG festgestellt ist.

Dr. Gerhard Felten

Dr. Eckerhard Strötgen

ppa. Felten i.V. Strötgen

Robert Bosch GmbH, Geschäftsbereich Elektrowerkzeuge

Änderungen vorbehalten

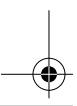
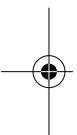



Sicherheitshinweise für Druckluftgeräte

Achtung! Beim Gebrauch von Druckluftgeräten sind zum Schutz gegen Verletzungsgefahr folgende grundsätzliche Sicherheitsmaßnahmen zu beachten. Lesen und beachten Sie diese Hinweise, bevor Sie das Gerät benutzen.

- 1. Halten Sie Ihren Arbeitsbereich in Ordnung**
Unordnung im Arbeitsbereich ergibt Unfallgefahr.
 - 2. Berücksichtigen Sie Umgebungseinfüsse**
Sorgen Sie für gute Beleuchtung. Arbeiten Sie nicht in explosionsgefährdeter Umgebung.
 - 3. Halten Sie Kinder vom Arbeitsbereich fern**
Halten Sie andere Personen von Ihrem Arbeitsbereich fern.
 - 4. Bewahren Sie Geräte und Werkzeuge sicher auf**
Unbenutzte Geräte und Einsatzwerkzeuge sollen in einem trockenen, verschlossenen Raum und für Kinder nicht erreichbar aufbewahrt werden.
 - 5. Kontrollieren Sie die Luftversorgung**
Kontrollieren Sie regelmäßig die Luftversorgung. Sämtliche Armaturen, Verbindungsleitungen und Schläuche müssen dem Druck und der erforderlichen Luftmenge entsprechend ausgelegt sein. Schützen Sie den Schlauch vor Knicken, Verengungen, Hitze und scharfen Kanten. Lassen Sie beschädigte Schläuche und Kupplungen sofort instand setzen, und ziehen Sie die Schlauchschellen fest an. Schrattarte Luftversorgung kann einen herumschlagenden Druckluftschlauch verursachen und zu Verletzungen führen. Aufgewirbelter Staub oder Späne können schwere Augenverletzungen hervorrufen.
 - 6. Benutzen Sie das richtige Werkzeug**
Verwenden Sie keine zu schwachen Geräte oder Vorstanzwerkzeuge für schwere Arbeiten. Benutzen Sie Geräte nicht für Zwecke und Arbeiten, für die sie nicht bestimmt sind.
 - 7. Tragen Sie geeignete Arbeitskleidung**
Tragen Sie keine weite Kleidung oder Schmuck. Sie können vor beweglichen Teilen erfaßt werden. Tragen Sie bei langen Haaren ein Haarnetz. Bei Arbeiten im Freien ist rutschfestes Schuhwerk empfehlenswert.
 - 8. Benutzen Sie eine Schutzbrille**
Verwenden Sie eine Staubschutzmaske bei staub-erzeugenden Arbeiten.
 - 9. Sichern Sie das Werkstück**
Benutzen Sie Spannvorrichtungen oder einen Schraubstock, um das Werkstück festzuhalten. Es ist damit sicherer gehalten als mit Ihrer Hand und ermöglicht die Bedienung der Maschine mit beiden Händen.
 - 10. Sorgen Sie für einen sicheren Stand**
Vermeiden Sie abnorme Körperhaltung. Sorgen Sie für sicheren Stand, und halten Sie jederzeit das Gleichgewicht.
 - 11. Pflegen Sie Gerät und Werkzeuge mit Sorgfalt**
Halten Sie Ihr Gerät sauber und Ihre Werkzeuge scharf, um gut und sicher zu arbeiten. Befolgen Sie die Wartungsvorschriften und die Hinweise für Werkzeugwechsel. Halten Sie die Handgriffe trocken und frei von Öl und Fett.
 - 12. Unterbrechen Sie die Luftversorgung**
Unterbrechen Sie die Luftversorgung bei Nichtgebrauch und vor der Wartung des Gerätes sowie vor dem Wechsel von Einsatzwerkzeugen.
 - 13. Lassen Sie keine Werkzeugschlüssel stecken**
Überprüfen Sie vor dem Einschalten des Gerätes, daß die Schlüssel und Einstellwerkzeuge entfernt sind.
 - 14. Vermeiden Sie unbeabsichtigten Anlauf**
Tragen Sie niemals an die Luftversorgung angeschlossene Geräte mit dem Finger am Schalter. Vergewissern Sie sich, daß das Gerät beim Anschluß an die Luftversorgung ausgeschaltet ist.
 - 15. Selen Sie stets aufmerksam**
Beobachten Sie Ihre Arbeit. Gehen Sie vernünftig vor. Verwenden Sie das Gerät nicht, wenn Sie unkonzentriert sind.
 - 16. Kontrollieren Sie Ihr Gerät auf Beschädigungen**
Überprüfen Sie vor Gebrauch des Gerätes die Schutzrichtungen oder leicht beschädigte Teile sorgfältig auf ihre einwandfreie und bestimmungsgemäße Funktion. Kontrollieren Sie, ob die Funktion beweglicher Teile in Ordnung ist, ob sie nicht kleben oder ob Teile beschädigt sind. Sämtliche Teile müssen richtig montiert sein und alle Bedingungen erfüllen, um den einwandfreien Betrieb des Gerätes zu gewährleisten. Beschädigte Schutzvorrichtungen und Teile sollen sachgemäß durch eine Kundendienstwerkstatt repariert oder ausgetauscht werden, soweit nichts anderes in den Betriebsanleitungen angegeben ist. Beschädigte Schalter müssen bei einer Kundendienstwerkstatt ersetzt werden. Benutzen Sie keine Geräte, bei denen sich der Schalter nicht ein- und ausschalten läßt.
 - 17. Achtung!**
Zu Ihrer eigenen Sicherheit, benutzen Sie nur Zubehör und Zusatzgeräte, die in der Bedienungsanleitung angegeben werden. Der Gebrauch anderer als der in der Bedienungsanleitung oder im Katalog empfohlenen Einsatzwerkzeuge oder Zubehöre kann eine persönliche Verletzungsgefahr für Sie bedeuten.
 - 18. Reparaturen nur von einer Fachkraft**
Dieses Druckluftgerät entspricht den einschlägigen Sicherheitsbestimmungen. Reparaturen dürfen nur von einer Fachkraft ausgeführt werden, andernfalls können Unfälle für den Betreiber entstehen.
- Bewahren Sie die Sicherheitshinweise gut auf.**

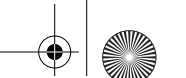

Product Specifications

Pneumatic Motor 180 W

Order number 0 607 953 308	... 309	... 310	... 311	... 312	... 313
No-load speed	[RPM] 820	1 250	1 700	3 000	5 400	660
Stall torque	[Nm] 8.0	5.3	3.7	2.1	1.1	7.5
Power output	[W] 180	180	180	180	180	160
Rotational direction						
Tool holder	3/8"-24 UNF-2A ●	●	●	●	●	●
Rated pressure	[bar/psi] 6.3/90	6.3/90	6.3/90	6.3/90	6.3/90	6.3/90
Hose connection fitting	G 1/8"	G 1/8"	G 1/8"	G 1/8"	G 1/8"	G 1/8"
Inside hose dia.	[mm] 6	6	6	6	6	6
Air consumption under load	[l/s] 6.0	6.0	6.0	6.0	6.0	7.2
Weight (without accessories) approx.	[kg] 0.58	0.58	0.58	0.50	0.50	0.64

Pneumatic Motor 180 W

Order number 0 607 953 314	... 315	... 316	... 317	... 326
No-load speed	[RPM] 1 050	1 400	2 600	4 600	2 000
Stall torque	[Nm] 5.1	3.5	2.0	1.0	3.1
Power output	[W] 160	160	160	160	180
Rotational direction					
Tool holder	3/8"-24 UNF-2A ●	●	●	●	●
Rated pressure	[bar/psi] 6.3/90	6.3/90	6.3/90	6.3/90	6.3/90
Hose connection fitting	G 1/8"	G 1/8"	G 1/8"	G 1/8"	G 1/8"
Inside hose dia.	[mm] 6	6	6	6	6
Air consumption under load	[l/s] 7.2	7.2	7.2	7.2	6.0
Weight (without accessories) approx.	[kg] 0.64	0.64	0.56	0.56	0.58

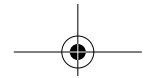

3 609 929 498 • 99.10

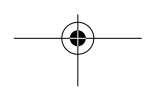

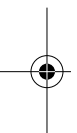

Pneumatic Motor 120 W

Order number 0 607 954 304	... 305	... 306	... 307
No-load speed	[RPM] 2 200	4 900	1 850	4 100
Stall torque	[Nm] 2.1	1.0	2.0	0.9
Power output	[W] 120	120	100	100
Rotational direction				
Tool holder	3/8"-24 UNF-2A ●	●	●	●
Rated pressure	[bar/psi] 6.3/90	6.3/90	6.3/90	6.3/90
Hose connection fitting	G 1/8"	G 1/8"	G 1/8"	G 1/8"
Inside hose dia.	[mm] 6	6	6	6
Air consumption under load	[l/s] 4.5	4.5	5.0	5.0
Weight (without accessories) approx.	[kg] 0.37	0.32	0.37	0.32





Product Elements

- 1 Tool holder
- 2 Clamping area
- 3 Hose connection for right rotation 
- 4 Hose connection for left rotation ; only for units with 
- 5 Air outlet with silencer*

* **Optional accessories**
Not all the accessories illustrated or described are included in standard delivery.

Accessories

Hose connection piece, 3 603 386 002
 Silencer 3 607 000 016
 Fastening flange 180 W 3 605 700 044
 Fastening flange 120 W 3 605 700 043
 Special gearbox grease 225 ml 3 605 430 009



For Your Safety



Working safely with this machine is possible only when the operating and safety information are read completely and the instructions contained therein are strictly followed.

In addition, the Section Safety Instructions for Pneumatic Tools must be observed.

Before using for the first time, ask for a practical demonstration.

- **Disconnect the air supply.**
 Disconnect the air supply when the machine is not in use, before maintenance work and for the changing of the tools.
- Keep hands away from the rotating tool holder as well as the tool. For breakage of the tool, splinters that fly off can cause injuries.
- **Be careful in confined working conditions.**
 As a result of the reaction torque, injuries can occur from squeezing or pinching.
- **Do not overload the tool.**
 Work with the rated pressure specified. All fittings, connecting lines and hoses must be dimensioned for the required air pressure and volume.
- When clamping the pneumatic motor in a clamping device, use the clamping area and observe the safety instructions of the clamping device.
- Do not overload the clamping area of the pneumatic motor.
- Bosch can assure flawless functioning of the machine only when original accessories are used.

Air Supply

The supplied air must be free of foreign material and humidity to protect the unit from damage, contamination and rust.

The use of a pressurised air maintenance unit is necessary.

All fittings, connecting lines and hoses must be dimensioned for the required air pressure and volume. Avoid restrictions in the air supply resulting from, e.g., pinching, kinking or stretching!

In case of doubt, measure the pressure with an pressure gauge at the air inlet with the unit switched on.

Maintenance Unit

The maintenance unit ensures fault-free functioning of pneumatic tools.

It consists of three major components:

- Filter with water separator,
- Pressure reduction valve with pressure gauge,
- Mist oiler.

Lubricant in the mist oiler: Motor oil SAE 10/SAE 20.

Do not use paraffin or diesel oil.

Adjust the mist oiler so that a thin film of oil collects on the air outlet.

Observe the operating instructions of the maintenance unit.

Before Use

Attach the pneumatic motor only in the clamping area **2** indicated and use the complete clamping area, if possible. The smaller the clamping area, the higher the effect of the clamping force.

- Do not overload the clamping area of the pneumatic motor.

Assembly

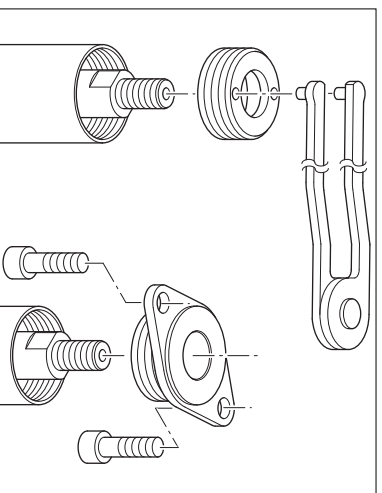

Screw out the threaded ring with a pin spanner (left-hand threads) and screw in the mounting flange. The pneumatic motor can be bolted to the mounting device with two bolts on the mounting flange.

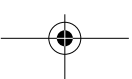
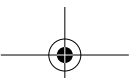



Putting into Operation

The unit operates optimally with a pressure of 6.3 bar (90 psi) measured at the air inlet with the unit running.

Switching On / Off

If the unit does not start, e.g. after not being used for a longer time, disconnect the air supply and turn the tool holder **1** by hand. Adhesive forces are eliminated in this manner.



For an interruption of the air supply or reduced operating pressure, switch off the machine. Check the operating pressure and start again when the pressure returns to normal.

The switching on and off of the unit takes place by switching the compressed air supply on or off.

Working Instructions

Before performing any work on the unit itself, disconnect the air supply.

Direction of Rotation

Depending on the desired direction of rotation, connect the air supply to the left or the right hose connection piece.

Excess loads that cause the machine to stall or reduce speed will not damage the motor.

Type 0 607 953 308 / ... 309 / ... 310 / ... 311 / ... 312 / ... 326

Type 0 607 954 304 / ... 305

Rotation to the right:

Connect the air supply hose to the hose connection **3**.



For higher torques, a correspondingly greater counterforce is necessary.

With a clamping device in the area **2**, this counterforce can more easily be counteracted.

Take care that the auxiliary handle or the clamping device holds the unit in a firm and secure manner.

Type 0 607 953 313 / ... 314 / ... 315 / ... 316 / ... 317

Type 0 607 954 306 / ... 307

Rotation to the right:

Connect the air supply hose to the hose connection **3**.

Rotation to the left:

Connect the air supply hose to the hose connection **4**.



For higher torques, a correspondingly greater counterforce is necessary.

With a clamping device in the area **2**, this counterforce can more easily be counteracted.

Take care that the auxiliary handle or the clamping device holds the unit in a firm and secure manner.

Torque

The rotational torque is controllable by means of the operating pressure.

The stated no-load rotational speed is achieved with the silencer connected. If the silencer is removed, the speed must be checked. Excessive speed is to be reduced to the rated speed with a choke.

Excessive speed causes unnecessary noise and shortens the service life of the unit.

Extraction of the Exhaust Air

After removing the silencer **5** a hose can be connected to the air outlet that leads away the exhaust air.

Advantages:

- Noise reduction
- No contamination of the working area by stirred up dust
- Exhaust air led away.

Maintenance and Cleaning

Before performing any work on the unit itself, disconnect the air supply.

Keep the unit and the tool holder clean at all times.

If the machine should happen to fall despite the care taken in manufacture and testing, repair should be carried out by an authorised customer services agent for Bosch pneumatic tools.

For all correspondence and spare parts orders, always include the 10-digit order number of the machine.

Lubrication



Lubricant:
Special gearbox grease
225 ml 3 605 430 009
SAE 10/SAE 20 motor oil

Wash out the gearbox with petroleum after the first approx. 150 hours of operation and then every 300 hours of operation and lubricate with special gearbox grease.

Any Bosch customer service centre can perform this work quickly and reliably.

Dispose of lubricants and cleaning agents in an environmentally correct manner. Observe legal regulations.

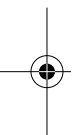
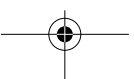
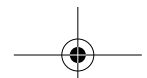



Preferential Partner

Great Britain

CC Tools
 29 Clophill Road
 Maulden
 Bedford MK452AA
 ☎ (1525) 840755
 Fax (1525) 840772

Terratruck
 34,36 Gipsy Lane
 Leicester LE4 6RB
 ☎ (116) 2662456
 Fax (116) 533610304

Rewinds & Windsor
 81 Regent Road
 Liverpool L59SY
 ☎ (151) 2072074
 Fax (151) 2981442

Air Tool Northern
 Millshaw Park Tr. Est.
 Elland Road
 Leeds LS11 02X
 ☎ (113) 2714420
 Fax (113) 2716904

Price Tool Sales
 50 Summer Lane
 Birmingham B193TL
 ☎ (121) 3598891
 Fax (121) 3591621

Ireland

Pneumatics Ltd.
 Old Naas Road
 Bluebell
 Dublin 12
 ☎ (01) 4568111
 Fax (01) 4568108

USA

Bosch Automation Products
 816 East Third Street
 Buchanan, MI 49107
 ☎ (616) 697-5260
 Fax (616) 695-5363

Guarantee

We guarantee Bosch products in accordance with statutory/country-specific regulations (proof of purchase by invoice or delivery note).
 Damage attributable to normal wear and tear, overload or improper handling will be excluded from the guarantee.

In case of a claim, please send the machine, **completely assembled**, to your dealer or the Bosch Service Centre for pneumatic tools.

Environmental Protection



Recycle raw materials instead of disposing as waste.

Machine, accessories and packaging should be sorted for environment-friendly recycling.
 These instructions are printed on recycled paper manufactured without chlorine.

Manufacturer's declaration

Manufacturer's declaration in accordance with 98/37/EG:

This product is intended exclusively for installation in another machine or for assembly as a part of another machine or other machines. Placing into operation is prohibited until the conformity of the end product with the provisions of the regulation 98/37/EG is determined.

Dr. Gerhard Felten

Dr. Eckerhard Strötgen

ppa. Felten i.V. Muffen

Robert Bosch GmbH, Geschäftsbereich Elektrowerkzeuge





Safety Instructions for Pneumatic Tools

Caution! To protect against injury when using pneumatic tools, the following general safety measures are to be observed.
Read and observe these instructions before using the machine.

- 1. Always keep the work area orderly.**
Disorder in the work area can cause accidents.
 - 2. Take ambient conditions into consideration.**
Provide for good lighting. Do not work in areas where the danger of explosion exists.
 - 3. Keep children out of the working area.**
Keep other persons away from your working area.
 - 4. Store the machine and tools safely.**
The unused machine and tools should be stored in a dry, closed room that is not accessible for children.
 - 5. Check the air supply.**
Check the air supply regularly. All fittings, connecting lines and hoses must be constructed to withstand the pressure and provide the required air volume. Protect the hose from kinks, restrictions, heat and sharp edges. Have damaged hoses and couplings repaired immediately and tighten the hose clamps firmly. Damage to the air supply can cause a pressure hose to whip about and lead to injury. Stirred up dust or cutting chips can cause serious eye injuries.
 - 6. Use the correct tool.**
Do not use a machine or tool attachment that is too small for heavy work. Do not use machines for purposes and jobs for which they were not intended.
 - 7. Wear suitable clothing.**
Do not wear loose clothing or jewellery that could become caught in moving parts of the machine. Wear a hair net for long hair. For outside work, non-skidding shoes are recommended.
 - 8. Wear protective glasses.**
For work that produces dust, also wear a dust mask.
 - 9. Secure the Workpiece**
Use clamping devices or a vice to hold the workpiece in place. In this manner, it is held more securely than with your hand and makes possible the operation of the machine with both hands.
 - 10. Provide for a secure stance.**
Avoid abnormal body positions. Provide for a secure stance and always keep your balance.
 - 11. Take good care of the machine and tools.**
Keep the machine clean and tools sharp for safe and efficient working. Observe the maintenance and the tool change instructions. Keep the hand grips dry and free from oil and grease.
 - 12. Disconnect the air supply.**
Disconnect the air supply when the machine is not in use, before maintenance work and for the changing of the insertion tools.
 - 13. Never leave the tool key inserted.**
Check before switching on the machine that the tool key or adjustment tools have been removed.
 - 14. Avoid unintentional switching on.**
Never carry a machine that is connected to the air supply with the finger on the switch. Ensure that the machine is switched off when connecting to the air supply.
 - 15. Stay constantly alert.**
Observe the work continuously. Proceed in a sensible manner. Do not use the machine when your concentration is poor.
 - 16. Check the machine for damage.**
Before using the machine, carefully check the protective devices and the easily damaged parts for flawless functioning as intended. Check if the function of moving parts is in order, that they are not jammed or if parts are damaged. All parts must be properly mounted and all conditions fulfilled to ensure the flawless operation of the machine.
Damaged protective devices and parts should be repaired or replaced in a professional manner by an authorised customer service facility if nothing to the contrary is noted in the operating instructions. Damaged switches must be replaced by a customer service facility. Do not use a machine that cannot be switched on and off with the switch.
 - 17. Caution!**
For your own safety, use only accessories and attachments that are referred to in the operating instructions. The use of tool inserts or accessories other than those recommended in the operating instructions or in the catalogue can result in the danger of personal injury.
 - 18. Have repairs performed only by a specialist.**
This pneumatic tool complies with the relevant safety regulations. Repairs should be performed only by a specialist, otherwise, accidents to the operator can occur.
- Save these safety instruction in an accessible place.**

3 609 929 498 • 99.10

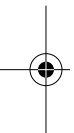
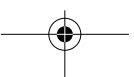
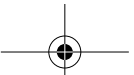

**Caractéristiques techniques**

F

**Moteur Pneumatique 180 W**

Référence 0 607 953 308	... 309	... 310	... 311	... 312	... 313
Vitesse à vide	[min ⁻¹] 820	1 250	1 700	3 000	5 400	660
Couple de calage	[Nm] 8,0	5,3	3,7	2,1	1,1	7,5
Puissance débitée	[W] 180	180	180	180	180	160
Rotation	↺	↺	↺	↺	↺	↺
Fixation de l'outil	3/8"-24 UNF-2A ●	●	●	●	●	●
Pression nominale	[bar/psi] 6,3/90	6,3/90	6,3/90	6,3/90	6,3/90	6,3/90
Raccord d'arrivée de l'air comprimé	G 1/8"	G 1/8"	G 1/8"	G 1/8"	G 1/8"	G 1/8"
Ø intérieur du tuyau	[mm] 6	6	6	6	6	6
Consommation sous charge	[l/s] 6,0	6,0	6,0	6,0	6,0	7,2
Masse (sans accessoires) env.	[kg] 0,58	0,58	0,58	0,50	0,50	0,64

Moteur Pneumatique 180 W

Référence 0 607 953 314	... 315	... 316	... 317	... 326
Vitesse à vide	[min ⁻¹] 1 050	1 400	2 600	4 600	2 000
Couple de calage	[Nm] 5,1	3,5	2,0	1,0	3,1
Puissance débitée	[W] 160	160	160	160	180
Rotation	↺	↺	↺	↺	↺
Fixation de l'outil	3/8"-24 UNF-2A ●	●	●	●	●
Pression nominale	[bar/psi] 6,3/90	6,3/90	6,3/90	6,3/90	6,3/90
Raccord d'arrivée de l'air comprimé	G 1/8"	G 1/8"	G 1/8"	G 1/8"	G 1/8"
Ø intérieur du tuyau	[mm] 6	6	6	6	6
Consommation sous charge	[l/s] 7,2	7,2	7,2	7,2	6,0
Masse (sans accessoires) env.	[kg] 0,64	0,64	0,56	0,56	0,58

3 609 929 498 • 99.10



**Moteur Pneumatique 120 W**

Référence 0 607 954 304	... 305	... 306	... 307
Vitesse à vide	[min ⁻¹] 2 200	4 900	1 850	4 100
Couple de calage	[Nm] 2,1	1,0	2,0	0,9
Puissance débitée	[W] 120	120	100	100
Rotation	↺	↺	↺	↺
Fixation de l'outil	3/8"-24 UNF-2A ●	●	●	●
Pression nominale	[bar/psi] 6,3/90	6,3/90	6,3/90	6,3/90
Raccord d'arrivée de l'air comprimé	G 1/8"	G 1/8"	G 1/8"	G 1/8"
Ø intérieur du tuyau	[mm] 6	6	6	6
Consommation sous charge	[l/s] 4,5	4,5	5,0	5,0
Masse (sans accessoires) env.	[kg] 0,37	0,32	0,37	0,32





Éléments de l'appareil

- 1 Fixation de l'outil
- 2 Zone de fixation
- 3 Raccord d'arrivée d'air pour une rotation à droite 
- 4 Raccord d'arrivée d'air pour une rotation à gauche , pour les appareils proposant des rotations , exclusivement
- 5 Sortie de l'air, avec silencieux*

*Accessoires

Les accessoires reproduits ou décrits ne sont pas tous compris dans les fournitures.

Accessoires

Tubulure du tuyau d'arrivée de l'air comprimé	3 603 386 002
Stencieux	3 607 000 016
Bride de fixation 180 W	3 605 700 044
Bride de fixation 120 W	3 605 700 043
Graisse spéciale pour engrenages 225 ml	3 605 430 009



Pour votre sécurité



Pour travailler sans risque avec cet appareil, lire intégralement au préalable les instructions de service et les remarques concernant la sécurité. Respecter scrupuleusement les indications et les consignes qui y sont données.

3 609 929 498 • 99.10



Il est par ailleurs impératif de prendre connaissance et de respecter la section **Consignes de sécurité pour outillages pneumatiques**. Avant la première mise en service, laisser quelqu'un connaissant bien cet appareil vous instruire de la manière de s'en servir.

- **Coupez l'alimentation en air comprimé**
Coupez l'alimentation en air comprimé lorsque l'outillage n'est pas utilisé, avant toute intervention de maintenance, tout changement ou remplacement d'outil.
- Ne pas manipuler ni approcher les mains de la fixation d'outil ou de l'outil en rotation. Si l'outil se rompt, les morceaux projetés par la force centrifuge peuvent générer des blessures.
- **Attention aux postes de travail exigus.**
Les couples de réaction peuvent parfois générer des blessures (par coincement ou pincement!).
- **Ne pas dépasser la capacité de charge de l'appareil.**
Travailler avec la pression d'air comprimé nominale.
Toute la tuyauterie, tous les raccords et autres flexibles doivent être dimensionnés pour supporter la pression et le débit nécessaires.

- Lors de la mise en place du moteur pneumatique dans un dispositif de fixation, toujours utiliser la bride de fixation. Prendre connaissance et observer les consignes de sécurité inhérentes au dispositif de fixation mis en œuvre.

- Ne pas solliciter la zone de fixation hors de toute proportion.
- Bosch ne peut se porter garant du bon fonctionnement de cet appareil que s'il a été utilisé avec les accessoires d'origine.

Alimentation en air comprimé

Afin de protéger la machine contre toute détérioration, pollution ou formation de rouille, il convient d'utiliser un air comprimé exempt d'humidité ou de tout corps étranger.

L'utilisation d'une unité de traitement de l'air comprimé est nécessaire.

Toutes les longueurs de tuyauterie, de conduites et de tuyaux souples doivent être dimensionnées pour convenir à la pression et au débit d'air comprimé nécessaires.

Prévenir, éviter l'étranglement des conduites d'alimentation! Prévenir, éviter tout rétrécissement du diamètre intérieur du tuyau d'alimentation en air comprimé (écrasement, pincement, etc.)!

Dans le doute, toujours vérifier la pression à l'entrée de la machine avec un manomètre.

Unité de traitement de l'air comprimé

L'unité de traitement de l'air comprimé permet de garantir le bon fonctionnement des outillages travaillant à l'air comprimé.

Une telle unité est essentiellement constituée des trois éléments fonctionnels suivants :
 – un filtre équipé d'un purgeur,
 – un vanne de réduction de la pression avec manomètre,
 – un graisseur à brouillard d'huile.

Lubrifiant pour les graisseurs à brouillard d'huile : huile pour moteur SAE 10 / SAE 20.

Ne pas utiliser d'essence ou de gazole.

Régler les graisseurs à brouillard d'huile de telle manière qu'un fin film d'huile se forme au niveau de la tubulure de sortie de l'air comprimé.

Prendre connaissance et tenir compte de la notice d'emploi de l'unité de traitement de l'air comprimé.

Avant la mise en service

Ne fixer le moteur qu'en utilisant la zone de fixation 2 prévue à cet effet. Exploiter dans la mesure du possible toute la zone de fixation. Plus la zone de fixation est réduite, plus les forces de fixation qui s'exerceront sur le moteur seront élevées.

- Ne pas solliciter la zone de fixation hors de toute proportion.





Remontage

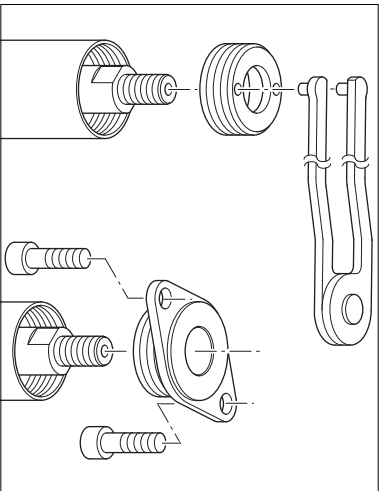

Dévisser la bague filetée avec une clé à ergot (pas à gauche !). Mettre en place la bride de fixation. Deux vis permettent alors de fixer le moteur pneumatique sur le dispositif de fixation.

Mise en service

Le rendement et les performances de la machine sont optimales lorsque la surpression mesurée au niveau du raccord d'arrivée d'air (la machine étant en fonctionnement) est égale à 6,3 bars.

Mise en marche / Arrêt

Si la machine ne démarre pas (après une longue période de non fonctionnement, par exemple), couper l'arrivée d'air comprimée et faire tourner la broche **1** à la main. Cette seule action suffira à vaincre et supprimer ce blocage intempêti.



En cas de coupure de l'alimentation en air comprimé ou de réduction de la pression de service, arrêter l'appareil, contrôler la pression de service et reprendre le travail avec l'appareil qu'une fois que la pression de service est fiable.

La mise en marche (respectivement : l'arrêt) de l'appareil s'effectue par une simple mise (respectivement : coupure) de la pression d'air comprimé.

Instructions d'utilisation

Avant d'entreprendre tout travail sur la machine elle-même, toujours couper l'arrivée d'air comprimé.

Sens de rotation

Raccorder la gaine ou le tuyau d'arrivée d'air comprimé soit à la tubulure droite, soit à la tubulure gauche (en fonction du sens de rotation souhaité).

Les augmentations brusques de charge peuvent se traduire par une forte diminution de la vitesse de rotation voire une immobilisation complète. Cependant, ces variations de charge brusques n'endommagent pas le moteur.

16

Modèle 0 607 953 308 / ... 309 / ... 310 /

... 311 / ... 312 / ... 326

Modèle 0 607 954 304 / ... 305

Rotation à droite:

Brancher le tuyau d'arrivée de l'air comprimé au raccord **3**.



Pour les couples de serrage élevés, il convient de maintenir l'appareil avec la force (le couple) nécessaire.

La mise en oeuvre d'un dispositif de fixation au niveau de la zone de fixation **2** permet d'absorber plus confortablement les forces de réaction.

S'assurer que la poignée supplémentaire ou le dispositif de blocage maintient l'outillage correctement et avec toute la sécurité souhaitable.

Modèle 0 607 953 313 / ... 314 / ... 315 /

... 316 / ... 317

Modèle 0 607 954 306 / ... 307

Rotation à droite:

Brancher le tuyau d'arrivée de l'air comprimé au raccord **3**.

Rotation à gauche:

Brancher le tuyau d'arrivée de l'air comprimé au raccord **4**.



Pour les couples de serrage élevés, il convient de maintenir l'appareil avec la force (le couple) nécessaire.

La mise en oeuvre d'un dispositif de fixation au niveau de la zone de fixation **2** permet d'absorber plus confortablement les forces de réaction.

S'assurer que la poignée supplémentaire ou le dispositif de blocage maintient l'outillage correctement et avec toute la sécurité souhaitable.

Couple

Il est possible de faire varier le couple fourni par ce type de moteur en jouant sur la pression de service.

La vitesse de rotation à vide indiquée se règle lorsque le silencieux est monté. Si le silencieux est retiré, il convient de procéder à un nouveau contrôle de la vitesse de rotation à vide. Une vitesse de rotation trop élevée se corrige par la mise en place d'une manette d'étranglement.

Une vitesse de rotation trop élevée s'accompagne d'une augmentation désagréable de la pression acoustique et réduit la durée de vie du moteur pneumatique.

Evacuation de l'air comprimé

Après démontage du silencieux **5**, le raccordement d'une gaine souple sur la sortie d'air comprimé permet d'évacuer l'air consommé.

Avantages :

- réduction du niveau de bruit,
- pas de pollution du poste de travail générée par les poussières remuées,
- évacuation de l'air comprimé



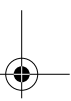

Maintenance et nettoyage

Toujours couper l'alimentation en air comprimé avant d'entreprendre un quelconque travail sur la machine elle-même.

La machine et la broche doivent rester propres. Les nettoyer régulièrement.

Si, malgré tous les soins apportés à la fabrication et au contrôle de l'appareil, celui-ci devait avoir un défaut, la réparation ne doit être confiée qu'à une station de service après-vente pour outillage Bosch agréé.

Pour toute demande de renseignement ou commande de pièces de rechange, nous précisons impérativement le numéro de référence à dix chiffres de la machine.



Lubrification

Lubrifiant :

Graisse spéciale pour engrenages 225 ml . . . 3 605 430 009

Huile pour moteurs SAE 10/SAE 20

Après 150 heures de fonctionnement la première fois, toutes les 300 heures ensuite, nettoyer les engrenages avec de l'éther de pétrole. Les lubrifier à nouveau avec de la graisse spéciale pour engrenages.

Les centres de services Bosch agréés sont en mesure d'exécuter ces travaux de maintenance de manière rapide et fiable.

Se débarrasser des produits de nettoyage et des lubrifiants usagés en respectant l'environnement. Tenir compte de la législation en vigueur.



3 609 929 498 • 99.10



Instructions de protection de l'environnement



Récupération des matières premières plutôt qu'élimination des déchets

Les machines, comme d'ailleurs leurs accessoires et emballages, doivent pouvoir suivre chacun une voie de recyclage appropriée.

Ce manuel d'instructions a été fabriqué à partir d'un papier recyclé blanc en l'absence de chlore.



Votre partenaire en outillage industriel

France

Outils Pneumatiques Globe
143, Av. Du Général de Gaulle
BP 102

92 252 La Garenne Colombes

☎ 1 47 80 20 81
Fax 1 47 80 29 13

Belgique

CEMAC TECHNAR
Afrikanlaan 289 A
9000 Gent

☎ (09) 259 02 62
Fax (09) 259 17 87

Suisse

Robert Bosch AG
Kundendienst Elektrowerkzeuge
Industriestrasse 31
8112 Otelfingen

☎ Service (01) 8 47 16 16
Service conseil client:
☎ Numéro Vert (0 800) 55 11 55

Déclaration du constructeur

Déclaration du constructeur par rapport à la directive 98/37/CE:

Ce produit est destiné à être intégré sur une autre machine ou à être utilisé en combinaison avec une ou plusieurs autres machines, et ce à l'exclusion de toute autre utilisation. La mise en oeuvre de ce produit n'est pas autorisée tant que la conformité du produit final aux termes de la directive 98/37/CE n'a pas été confirmée.

Dr. Gerhard Felten

Dr. Eckerhard Strötgen

Rpa. Felten *i.v. Strötgen*

Robert Bosch GmbH, Geschäftsbereich Elektrowerkzeuge

Garantie

Les appareils Bosch sont garantis conformément aux dispositions légales/nationales (contre preuve d'achat: facture ou bordereau de livraison). Cette garantie implique le remplacement gratuit des pièces défectueuses. En tout état de cause s'applique la garantie légale couvrant toutes les conséquences des défauts ou vices cachés (Articles 1641 et suivants du Code civil).

Cette garantie correspond à un emploi normal de l'outil et exclut les avaries dues à un mauvais usage, à un entretien défectueux ou à l'usure normale. Le jeu de la garantie ne peut en aucun cas donner lieu à des dommages et intérêts.

Pour que cette garantie soit valable il y a lieu de retourner l'outil **non démonté** au vendeur ou à une station service Bosch accompagnée de la preuve d'achat mentionnant la date d'acquisition, le nom de l'utilisateur et le nom du revendeur.

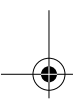
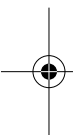



Consignes de sécurité pour outillages pneumatiques



Attention ! Afin de réduire les risques d'accidents, il convient d'observer les consignes de sécurité de base définies ci-après. Veuillez lire les présentes consignes avant toute utilisation et les appliquer.

- Tenez votre poste de travail correctement rangé**
Le désordre en cet endroit constitue un risque d'accident.
- Tenez compte de tous les paramètres extérieurs**
Veillez à travailler dans de bonnes conditions d'éclairage. Ne travaillez pas dans une zone où des risques d'explosions existent.
- Maintenez les enfants éloignés du poste de travail**
Maintenez toute tierce personne éloignée du poste de travail.
- Rangez comme il se doit outillages et outils**
Les outillages et outils non exploités doivent être rangés dans un local sec fermant à clé, auquel les enfants ne peuvent avoir accès.
- Contrôlez l'alimentation en air comprimé**
Contrôlez à intervalles réguliers l'alimentation en air comprimé. Toutes les tuyauteries, conduites de raccordement et gaines doivent avoir été dimensionnées pour supporter les pressions et débits nécessaires. Prévenez la formation de corde et/ou rétrécissement de la section des gaines. Evitez les sources de chaleur et les contacts avec les objets pointus ou effilés. Procédez sans délai à la remise en état ou au remplacement des gaines et raccords endommagés. Serrez correctement les colliers de serrage. Une alimentation en air comprimé défectueuse est susceptible de provoquer le battement des gaines souples d'air comprimé et finalement conduire à des blessures. Les poussières et autres copeaux ainsi soulevés en tourbillons peuvent provoquer des blessures aux yeux.
- Utilisez toujours l'outil approprié**
N'utilisez pas d'appareils ou d'adaptateurs trop légers pour des travaux lourds. N'utilisez pas un outillage à une tâche ou un travail pour lequel il n'a pas été conçu.
- Portez toujours une tenue de travail appropriée**
Ne portez ni vêtement ample ni bijoux. Ils pourraient être happés par les éléments mobiles. Si vos cheveux sont longs, portez un filet de protection. Lors des travaux en extérieur, il est recommandé de porter des chaussures à semelles antidérapantes.
- Portez une paire de lunettes de protection**
Faites appel à un masque anti-poussières lorsque le travail génère de la poussière.
- Fixez bien la pièce**
Utilisez un dispositif de fixation de la pièce ou un état pour maintenir la pièce. Elle sera ainsi mieux maintenue en position que par l'une de vos mains. Ce faisant, vous disposez de vos deux mains pour travailler et commander l'outillage mis en oeuvre.
- Adoptez toujours une position de travail stable**
Evitez les positions corporelles anormales. Adoptez une position de travail stable et gardez l'équilibre à tout moment.
- Entretenez outillage et outils avec tout le soin nécessaire**
Maintenez l'outillage propre et les outils affûtés afin de travailler efficacement et en toute sécurité. Suivez les consignes de maintenance et de remplacement des outils. Les poignées des outillages doivent rester sèches et exemptes d'huile et de graisse.
- Coupez l'alimentation en air comprimé**
Coupez l'alimentation en air comprimé lorsque l'outillage n'est pas utilisé, avant toute intervention de maintenance, tout changement ou remplacement d'outil.
- N'oubliez pas de clé en prise sur l'appareil**
Avant de mettre l'outillage en marche, assurez vous que toute clé ou tout outil de réglage a bien été retiré.
- Evitez toute mise en marche intempestive**
Ne portez jamais un outillage pneumatique raccordé à l'air comprimé en laissant négligemment votre doigt sur l'interrupteur Marche/Arrêt ou la gâchette de mise en service. Avant de raccorder l'outillage pneumatique au circuit d'air comprimé, assurez vous toujours que l'outillage est en position « Arrêt ».
- Rester toujours vigilant**
Surveillez le travail en cours. Procédez toujours de manière prudente et modérée. N'utilisez pas l'outillage pneumatique dans les périodes de non concentration.
- Inspectez l'outillage, vérifiez qu'il n'est pas endommagé**
Avant de mettre en oeuvre un outillage, assurez vous toujours que les dispositifs de sécurité ou les pièces légèrement endommagées sont encore en parfait état de fonctionner comme il se doit. Contrôlez que rien ne gêne le mouvement des pièces mobiles, que l'outillage travaille normalement, que les pièces ne sont pas endommagées. Pour garantir un fonctionnement irréprochable, toutes les pièces constitutives de l'outillage doivent être en parfait état de fonctionner et avoir été montées correctement. Sauf indication expresse figurant dans la notice d'utilisation, les dispositifs de sécurité et les pièces endommagés doivent être remis en état ou remplacés dans les règles par un atelier de réparation agréé. Les interrupteurs endommagés doivent être remplacés dans un atelier de réparation agréé. N'utilisez jamais un outillage pneumatique dont l'interrupteur Marche/Arrêt est défectueux.
- Attention !**
Pour votre propre sécurité, n'utilisez que des accessoires, des outils ou autres adaptateurs expressément indiqués dans la notice d'utilisation. La mise en oeuvre d'outils ou d'accessoires distincts de ceux recommandés dans la notice d'utilisation ou dans le catalogue peut constituer un risque de blessure corporel pour vous ou votre entourage.
- Ne confiez une réparation qu'à des personnes qualifiées**
Cet outillage pneumatique est conforme aux réglementations de sécurité qui le concernent. Toute réparation doit être exécutée par une personne qualifiée. Le non respect de cette recommandation peut entraîner des accidents chez l'utilisateur.

Conservez soigneusement ces consignes de sécurité.

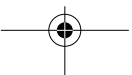
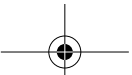

**Características técnicas**

E

**Motor neumático adaptable 180 W**

Número de pedido 0 607 953 308	... 309	... 310	... 311	... 312	... 313
Velocidad en vacío	[min ⁻¹] 820	1 250	1 700	3 000	5 400	660
Par de sobrecarga	[Nm] 8,0	5,3	3,7	2,1	1,1	7,5
Potencia útil	[W] 180	180	180	180	180	160
Dirección de giro	↻	↻	↻	↻	↻	↻
Portatútiles	3/8"-24 UNF-2A ●	●	●	●	●	●
Presión nominal	[bar/psi] 6,3/90	6,3/90	6,3/90	6,3/90	6,3/90	6,3/90
Racor para manguera	G 1/8"	G 1/8"	G 1/8"	G 1/8"	G 1/8"	G 1/8"
Díametro interior de manguera	[mm] 6	6	6	6	6	6
Consumo de aire bajo carga	[l/s] 6,0	6,0	6,0	6,0	6,0	7,2
Peso (sin accesorios) aprox.	[kg] 0,58	0,58	0,58	0,50	0,50	0,64

Motor neumático adaptable 180 W

Número de pedido 0 607 953 314	... 315	... 316	... 317	... 326
Velocidad en vacío	[min ⁻¹] 1 050	1 400	2 600	4 600	2 000
Par de sobrecarga	[Nm] 5,1	3,5	2,0	1,0	3,1
Potencia útil	[W] 160	160	160	160	180
Dirección de giro	↻	↻	↻	↻	↻
Portatútiles	3/8"-24 UNF-2A ●	●	●	●	●
Presión nominal	[bar/psi] 6,3/90	6,3/90	6,3/90	6,3/90	6,3/90
Racor para manguera	G 1/8"	G 1/8"	G 1/8"	G 1/8"	G 1/8"
Díametro interior de manguera	[mm] 6	6	6	6	6
Consumo de aire bajo carga	[l/s] 7,2	7,2	7,2	7,2	6,0
Peso (sin accesorios) aprox.	[kg] 0,64	0,64	0,56	0,56	0,58

3 609 929 498 • 99.10

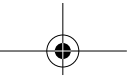

**Motor neumático adaptable 120 W**

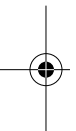
Número de pedido 0 607 954 304	... 305	... 306	... 307
Velocidad en vacío	[min ⁻¹] 2 200	4 900	1 850	4 100
Par de sobrecarga	[Nm] 2,1	1,0	2,0	0,9
Potencia útil	[W] 120	120	100	100
Dirección de giro	↻	↻	↻	↻
Portatútiles	3/8"-24 UNF-2A ●	●	●	●
Presión nominal	[bar/psi] 6,3/90	6,3/90	6,3/90	6,3/90
Racor para manguera	G 1/8"	G 1/8"	G 1/8"	G 1/8"
Díametro interior de manguera	[mm] 6	6	6	6
Consumo de aire bajo carga	[l/s] 4,5	4,5	5,0	5,0
Peso (sin accesorios) aprox.	[kg] 0,37	0,32	0,37	0,32





Elementos del aparato

- 1 Portátiles
- 2 Zona de agarre
- 3 Racor de manguera para giro a derechas 
- 4 Racor de manguera para giro a izquierdas  solamente en aparatos 
- 5 Salida de aire con silenciador*

*Accesorios

Los accesorios ilustrados o descritos pueden no corresponder al material suministrado de serie con el aparato.

Accesorios

Racor para manguera	3 603 386 002
Silenciador	3 607 000 016
Brida de montaje 180 W	3 605 700 044
Brida de montaje 120 W	3 605 700 043
Grasa especial para engranajes	
225 ml	3 605 430 009



Para su seguridad



Vd. solamente puede trabajar sin peligro con el aparato si lee íntegramente las instrucciones de manejo y las indicaciones de seguridad, atendiéndose estrictamente a las indicaciones allí comprendidas.

Debe considerarse además el párrafo *Instrucciones de seguridad para herramientas neumáticas*.

Déjese instruir prácticamente en el manejo antes de su primer empleo.

- **Interrumpa la alimentación de aire**
Desacople el aparato de la alimentación de aire siempre que deje de usarlo, antes de darle mantenimiento, y al cambiar los útiles.
- Mantenga alejadas las manos del portátiles y del útil en funcionamiento. En caso de que se presente una rotura del útil, los fragmentos que pudieran salir proyectados pueden llegar a lesionarle.
- **Precaución al trabajar en espacios restringidos**
Los fuertes pares de reacción pueden hacer que la máquina le cause lesiones por contusión o al quedar apisonado por ella.
- **No sobrecargar el aparato.**
Trabajar con la presión nominal prescrita. Todos los accesorios, tuberías de conexión y mangueras deben ser estar concebidos para la presión y el caudal de aire requeridos.
- Utilice la brida de montaje para acoplar el motor adaptable a un dispositivo de sujeción, atendiéndose para ello a las instrucciones de seguridad del dispositivo de sujeción.

- No apriete excesivamente la zona de agarre del motor adaptable.
- Bosch únicamente puede garantizar un funcionamiento correcto del aparato al emplear accesorios originales.

Alimentación de aire

El aire de alimentación debe estar exento de cuerpos extraños y de humedad, a fin de proteger el aparato de daños, suciedad y la formación de óxido.

Es necesario el uso de una unidad de mantenimiento para aire comprimido.

Todos los racores, tuberías y mangueras deben dimensionarse de acuerdo a la presión y cantidad de aire requerida.

Evitar estrechamientos en las mangueras debidos p. ej. a aplastamientos, dobleces o estrangulamientos!

En caso de duda verificar la presión con un manómetro en la entrada de aire con el aparato conectado.

Unidad de mantenimiento

La unidad de mantenimiento garantiza un funcionamiento sin problemas de las herramientas neumáticas.

- Se compone de tres elementos principales:
- filtro con decantador de agua,
- válvula de estrangulación con manómetro,
- lubricador por niebla.

Lubricante para lubricador por niebla: aceite para motores SAE 10/SAE 20.

No utilizar petróleo ni gasóleo.

Ajustar el lubricador por niebla de manera tal que se forme una delgada película lubricante a la salida de aire.

Observar las instrucciones de manejo de la unidad de mantenimiento.

Antes de utilizar el equipo

Sujete el motor adaptable únicamente por la zona de agarre **2** indicada, empleando para ello en lo posible la totalidad de la superficie disponible. Cuanto menor sea la superficie de agarre tanto mayor son los esfuerzos resultantes.

- No apriete excesivamente la zona de agarre del motor adaptable.

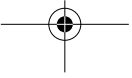
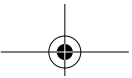



Montaje

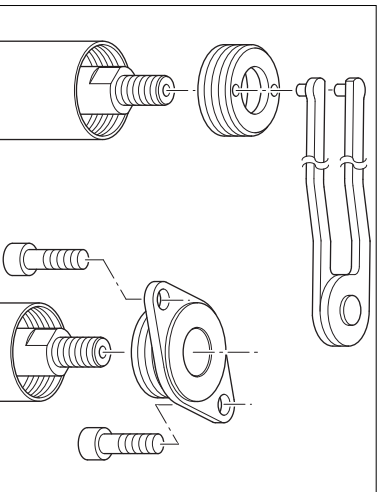

Desmonte el anillo roscado con una llave de pivotes (frosca a izquierdas!) y enrosque en su lugar la brida de montaje. El motor adaptable puede fijarse entonces al dispositivo de sujeción mediante dos tornillos.

Puesta en funcionamiento

El aparato trabaja de forma óptima con una sobrepresión de 6,3 bar (90 psi), medida en la entrada de aire con el aparato en marcha.

Conexión y desconexión

Caso de no ponerse el aparato en marcha, p. ej. tras un tiempo de reposo prolongado, interrumpir la alimentación de aire y girar a mano el portátiles **1**. De esta manera se eliminan las fuerzas adherentes.



Desconectar el aparato en caso interrumpirse la alimentación de aire, o de reducirse la presión de servicio. Verificar la presión de servicio y ajustarla de forma óptima antes de poner el aparato en marcha.

La conexión y desconexión del aparato se realiza conectando o desconectando la alimentación de aire comprimido.

Indicaciones de trabajo

Antes de realizar cualquier trabajo en el aparato interrumpir la alimentación de aire.

Dirección de giro

De acuerdo al sentido de giro deseado, la alimentación de aire debe conectarse al racor para manguera del lado izquierdo o derecho.

Las cargas repentinas que puedan presentarse pueden originar una fuerte reducción de las revoluciones, o incluso la detención del motor, sin que esto, sin embargo, llegue a dañarlo.

Tipo 0 607 953 308 / ... 309 / ... 310 /

... 311 / ... 312 / ... 326

Tipo 0 607 954 304 / ... 305

Giro a derechas:

conectar la manguera de alimentación al racor para manguera **3**.



En caso de un par de giro elevado se requiere de una fuerza opoante de sujeción correspondientemente alta.

Al montar un dispositivo de sujeción en la zona de agarre **2** es más fácil vencer este par opoante.

Preste atención a que la empuñadura adicional o el dispositivo de sujeción mantengan sujeto el aparato de forma segura y firme.

Tipo 0 607 953 313 / ... 314 / ... 315 /

... 316 / ... 317

Tipo 0 607 954 306 / ... 307

Giro a derechas:

conectar la manguera de alimentación al racor para manguera **3**.

Giro a izquierdas:

conectar la manguera de alimentación al racor para manguera **4**.



En caso de un par de giro elevado se requiere de una fuerza opoante de sujeción correspondientemente alta.

Al montar un dispositivo de sujeción en la zona de agarre **2** es más fácil vencer este par opoante.

Preste atención a que la empuñadura adicional o el dispositivo de sujeción mantengan sujeto el aparato de forma segura y firme.

Par de giro

El par de giro puede regularse con la presión de servicio.

La velocidad en vacío indicada se obtiene con el silenciador acoplado. Caso de desmontar el silenciador, debe comprobarse la velocidad de giro. Un velocidad de giro excesiva debe reducirse a la velocidad nominal mediante un estrangulador.

Una velocidad de giro excesiva genera un ruido innecesario, reduciendo además la vida útil del aparato.

Evacuación del aire de salida

Después de desmontar el silenciador **5** puede acoplarse una manguera para evacuar el aire de salida.

Ventajas:

- Reducción del ruido.
- Se evita la suciedad en el puesto de trabajo que originaría el polvo arremolinado.
- Conducción de la salida de aire.

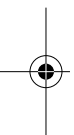
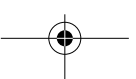



Mantenimiento y limpieza

Antes de realizar cualquier trabajo en el aparato interrumpir la alimentación de aire.

Mantener siempre limpios el aparato y el portátiles.

Si a pesar del cuidadoso proceso de fabricación y control la máquina sufriera un fallo, la reparación deberá encargarse a un punto de Servicio Técnico autorizado para herramientas eléctricas Bosch.

Al realizar consultas o solicitar piezas de repuesto, es imprescindible indicar siempre el número de pedido de 10 cifras.



Lubricación

Lubricante:

Grasa especial para engranajes 225 ml. 3 605 430 009

Aceite para motores SAE 10/SAE 20

Lavar el mecanismo por primera vez después de aprox. 150 horas de servicio, y seguidamente cada 300 horas de servicio con gasolina de lavado y lubricarlo con grasa especial para engranajes.

Un taller de servicio Bosch ejecuta estos trabajos de manera rápida y fiable.

Eliminar lubricantes y agentes limpiadores respetando el medio ambiente. Observar las prescripciones legales.

Garantía

Para los aparatos Bosch concedemos una garantía de acuerdo con las prescripciones legales específicas de cada país (comprobación a través de la factura o albarán de entrega).

Quedan excluidos de garantía los daños ocasionados por desgaste natural, sobrecarga o manejo inadecuado. Envíen Vds., por favor, en caso de posible reclamación la máquina **sin desmontar** al suministrador de la misma o a un servicio Técnico de Bosch.



Su contacto para herramientas industriales

ARENAZ

Lorenti 1

50005 Zaragoza

☎ 976 56 72 67

Fax 976 56 11 99

DISTRINORTE

Ctra. Galdacano, 18

48004 Bolueto-Bilbao

☎ 944 11 10 11

Fax 944 12 83 37

Edeirnitro Rodríguez

La Coruña

☎ 981 28 20 99

DAVASA

San Isidro 15-Zarandora

20007 Murcia

☎ 968 23 86 00

Fax 968 20 14 14

Amuc

Barcelona

☎ 775 49 18

MERCURIO S.A.

Trav. De Vigo 19

36206 Vigo

☎ 986 26 26 11

Fax 986 27 95 12

Protección del medio ambiente



Recuperación de materias primas en lugar de eliminación de desperdicios

El aparato, los accesorios y el embalaje deberían someterse a un proceso de recuperación que respete el medio ambiente.

Estas instrucciones se han impreso sobre papel reciclado sin la utilización de cloro.

Declaración del fabricante

Declaración del fabricante según 98/37/CE:

Este producto está previsto exclusivamente para ser montado en otra máquina, o para ser adaptado a otra máquina o máquinas. La puesta en marcha es prohibitiva hasta haber determinado la conformidad del producto final con las regulaciones 98/37/CE.

Dr. Gerhard Felten

Dr. Eckerhard Strötgen

ppa. Felten i. V. Strötgen

Robert Bosch GmbH, Geschäftsbereich Elektrowerkzeuge



Instrucciones de seguridad para aparatos neumáticos

¡Atención! Al utilizar aparatos neumáticos deben observarse siempre las siguientes medidas fundamentales de seguridad para evitar el riesgo de lesión. Lea estas indicaciones antes de utilizar el aparato y atégase a ellas.

- 1. Mantenga ordenada el área trabajo**
El desorden en el área de trabajo aumenta el peligro de accidentes.
- 2. Observe las condiciones del entorno**
Trabaje sólo con buena iluminación. No trabaje en entornos con peligro de explosión.
- 3. Mantenga alejados a los niños del área de trabajo**
Mantenga alejadas también a otras personas de su área de trabajo.
- 4. Guarde los aparatos y útiles de forma segura**
Los aparatos y útiles no utilizados deben guardarse en un lugar seco, cerrado, e inaccesible para los niños.
- 5. Controle la alimentación de aire**
Inspeccione periódicamente la alimentación de aire. Todos los accesorios, tuberías de conexión y mangueras deben estar concebidas para la presión y el caudal de aire requeridos. Proteja la manguera contra dobles, estrechamientos, del calor y de los bordes afilados. Haga reparar inmediatamente las mangueras y los elementos de conexión deteriorados, y apriete firmemente las abrazaderas. Una alimentación de aire incorrecta puede hacer que la manguera salga despedida de forma incontrolada pudiendo causar lesiones. El polvo o virutas levantados por el aire pueden dañar seriamente los ojos.
- 6. Utilice la herramienta adecuada**
No utilice aparatos o dispositivos adaptables demasiado enfebles al realizar trabajos rudos. No emplee los aparatos para fines ni trabajos para los que no han sido concebidos.
- 7. Lleve una vestimenta de trabajo adecuada**
No lleve una vestimenta demasiado holgada ni tampoco joyas, ya que pueden ser agarradas por las partes en movimiento. Si tiene el pelo largo recójase bajo una redcilla. Al realizar trabajos en la intemperie es recomendable emplear calzado con suela antideslizante.
- 8. Colóquese unas gafas de protección**
En aquellos trabajos que generen polvo colóquese además una careta antipolvo.
- 9. Asegure la pieza de trabajo**
Emplee dispositivos de sujeción o un tornillo de banco para sujetar la pieza de trabajo. Además de quedar fijada de manera más segura, esto le permite el manejo de la máquina con ambas manos.
- 10. Mantenga una posición firme**
Evite posturas desacomodadas. Mantenga una posición firme y consérvese siempre el equilibrio.
- 11. Cuide esmeradamente su aparato y los útiles**
Mantenga el aparato limpio y los útiles bien afilados para trabajar bien y seguro. Siga las prescripciones de mantenimiento y las instrucciones para el cambio de útil. Mantenga las empuñaduras secas y libres de aceite y grasa.
- 12. Interrumpa la alimentación de aire**
Desconecte el aparato de la alimentación de aire siempre que deje de usarlo, antes de darle mantenimiento, y al cambiar los útiles.
- 13. No deje puesta ninguna llave para útiles**
Antes de conectar el aparato verifique si ha retirado las llaves y útiles de ajuste.
- 14. Evite un arranque accidental**
No transporte jamás un aparato conectado a la alimentación de aire asíéndolo por el interruptor. Antes de conectar el aparato a la alimentación de aire, asegúrese primero de que esté desconectado.
- 15. Esté siempre atento**
Observe su trabajo. Proceda con sensatez. No utilice el aparato si no puede concentrarse.
- 16. Inspeccione su aparato**
Cada vez que vaya a usar el aparato inspecciónelo detenidamente para ver si los dispositivos protectores, o aquellas partes que estén ligeramente dañadas, funcionan de forma correcta y reglamentaria. Verifique si el funcionamiento de las piezas móviles es correcto, que no se atasquen y que no estén dañadas. Todas las partes deben estar correctamente montadas, debiendo satisfacer además todas las condiciones que aseguran la operación correcta del aparato.
Las partes y dispositivos protectores deteriorados deben hacerse reparar o sustituir de forma profesional en un taller de servicio, siempre que no se mencione algo diferente en las instrucciones de manejo. Los interruptores dañados deben sustituirse en un taller de servicio. No use aparatos con un interruptor defectuoso.
- 17. ¡Atención!**
Para su propia seguridad, utilice solamente los accesorios y aparatos suplementarios mencionados en las instrucciones de manejo. El uso de útiles o accesorios diferentes de los recomendados en las instrucciones de manejo o en el catálogo puede llegar a acarrear lesiones.
- 18. Reparaciones solamente por un profesional**
Este aparato neumático cumple con las prescripciones de seguridad pertinentes.
Las reparaciones deberá realizarlas únicamente un profesional, ya que de lo contrario el usuario corre peligro de accidentarse.

Guarde bien estas instrucciones de seguridad.

**Dados técnicos do aparelho****P****Motor pneumático para montagem 180 W**

Número de encomenda 0 607 953 308	... 309	... 310	... 311	... 312	... 313
Rotações em vazio	[min ⁻¹] 820	1 250	1 700	3 000	5 400	660
Momento de desconexão por sobrecarga	[Nm] 8,0	5,3	3,7	2,1	1,1	7,5
Potência útil	[W] 180	180	180	180	180	160
Sentido de rotação	↺	↺	↺	↺	↺	↺
Encabadoiro	3/8"-24 UNF-2A ●	●	●	●	●	●
Pressão nominal	[bar/psi] 6,3/90	6,3/90	6,3/90	6,3/90	6,3/90	6,3/90
Ligação da mangueira	G 1/8"	G 1/8"	G 1/8"	G 1/8"	G 1/8"	G 1/8"
Diâmetro interior da mangueira	[mm] 6	6	6	6	6	6
Consumo de ar sob carga	[l/s] 6,0	6,0	6,0	6,0	6,0	7,2
Peso (sem acessórios) aprox.	[kg] 0,58	0,58	0,58	0,50	0,50	0,64

Motor pneumático para montagem 180 W

Número de encomenda 0 607 953 314	... 315	... 316	... 317	... 326
Rotações em vazio	[min ⁻¹] 1 050	1 400	2 600	4 600	2 000
Momento de desconexão por sobrecarga	[Nm] 5,1	3,5	2,0	1,0	3,1
Potência útil	[W] 160	160	160	160	180
Sentido de rotação	↺	↺	↺	↺	↺
Encabadoiro	3/8"-24 UNF-2A ●	●	●	●	●
Pressão nominal	[bar/psi] 6,3/90	6,3/90	6,3/90	6,3/90	6,3/90
Ligação da mangueira	G 1/8"	G 1/8"	G 1/8"	G 1/8"	G 1/8"
Diâmetro interior da mangueira	[mm] 6	6	6	6	6
Consumo de ar sob carga	[l/s] 7,2	7,2	7,2	7,2	6,0
Peso (sem acessórios) aprox.	[kg] 0,64	0,64	0,56	0,56	0,58

3 609 929 498 • 99.10

Motor pneumático para montagem 120 W

Número de encomenda 0 607 954 304	... 305	... 306	... 307
Rotações em vazio	[min ⁻¹] 2 200	4 900	1 850	4 100
Momento de desconexão por sobrecarga	[Nm] 2,1	1,0	2,0	0,9
Potência útil	[W] 120	120	100	100
Sentido de rotação	↺	↺	↺	↺
Encabadoiro	3/8"-24 UNF-2A ●	●	●	●
Pressão nominal	[bar/psi] 6,3/90	6,3/90	6,3/90	6,3/90
Ligação da mangueira	G 1/8"	G 1/8"	G 1/8"	G 1/8"
Diâmetro interior da mangueira	[mm] 6	6	6	6
Consumo de ar sob carga	[l/s] 4,5	4,5	5,0	5,0
Peso (sem acessórios) aprox.	[kg] 0,37	0,32	0,37	0,32





Elementos do aparelho

- 1 Encabedouro
- 2 Área de aperto
- 3 Ligação de mangueira para marcha à direita
- 4 Ligação de mangueira para marcha à esquerda
- 5 Saída de ar com silenciador*

***Accessórios ilustrados ou descritos não estão totalmente abrangidos no fornecimento.**

Accessórios

Bocal da mangueira 3 603 386 002
 Silenciador 3 607 000 016
 Flangia di fissaggio 180 W 3 605 700 044
 Flangia di fissaggio 120 W 3 605 700 043
 Lubrificante especial para engrenagens 225 ml 3 605 430 009



Para sua segurança



Um trabalho seguro com o aparelho só é possível após ter lido atentamente as instruções de serviço e as indicações de segurança e após observar rigorosamente as indicações neias contidas.

Além disto deverá observar a secção Indicações de segurança para ferramentas pneumáticas. Uma instrução prática é vantajosa.

- **Interromper o abastecimento de ar**
Deverá interromper o abastecimento de ar, caso não utilizar o aparelho e antes da manutenção, assim como antes da substituição de ferramentas.
- Mantenha as mãos afastadas do encabedouro a girar, assim como da ferramenta introduzida. Se uma ferramenta quebrar, pode ser que voem aparas que possam produzir danos.
- **Atenção no caso de uma situação de trabalho aberta**
Devido a momentos de reacção, podem ocorrer lesões e danos provocados por estranhalamentos e esmagamentos.
- **Não sobrecarregar o aparelho.**
Trabalhar com a pressão nominal indicada. Todos os instrumentos, ligações e mangueiras devem ser apropriados para a pressão e a quantidade de ar necessárias para o trabalho.

- Para fixar o motor de montagem num dispositivo de fixação, deverá utilizar uma flange de fixação e observe as indicações de segurança do dispositivo de fixação.

- Não sobrecarregue a área de fixação do motor.
- A Bosch só pode garantir um funcionamento perfeito do aparelho, se forem utilizados acessórios genuínos Bosch.

Abastecimento de ar

O ar utilizado deve estar livre de impurezas e humidade, para que o aparelho possa ser protegido contra sujidade e formação de ferrugem.

É necessária a utilização de uma unidade de controle de ar comprimido.

Todos os equipamentos, cabos de ligação e mangueiras devem ser instalados de acordo com a pressão e a quantidade de ar necessária.

Evitar o estreitamento das mangueiras p. ex. devido à esmagamento, encurvamento ou distensão!

Em caso de dúvida controle a pressão na entrada de ar com o aparelho ligado utilizando um manómetro.

Unidade de manutenção

A unidade de manutenção assegura um funcionamento perfeito das ferramentas de ar comprimido.

- Filtro com separador de água.
- Válvula de redução de pressão com manómetro,
- Pulverizador de óleo.

Lubrificante no pulverizador de óleo: Óleo para motores SAE 10/SAE 20.

Não utilize petróleo ou óleo diesel.

Ajustar o pulverizador de óleo de modo que se forme uma fina camada de óleo no escape de ar.

Observar as instruções de serviço da unidade de manutenção.

Para sua segurança

Fixe o motor de montagem apenas na área de fixação **2**, e de preferência utilize a completa área de fixação. Quanto menor a área de fixação, quanto maior serão as forças exercidas.

- Não sobrecarregue a área de fixação do motor.

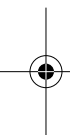
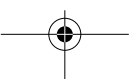
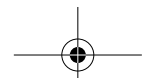



Montagem

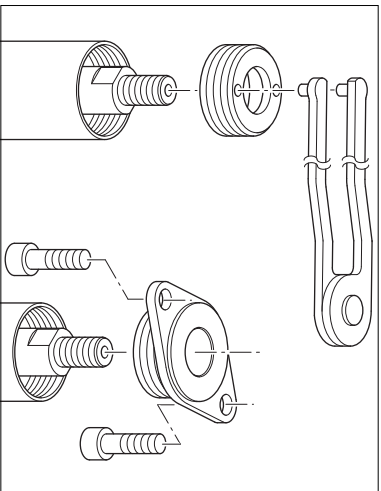

Aparatuse o anel roscado com uma chave fixa de gancho (frosca à esquerda) e a flange de fixação. Na flange de fixação é possível aparatuse o motor de montagem com dois parafusos ao dispositivo de fixação.

Colocação em funcionamento

O aparelho trabalha otimizado com uma pressão efectiva de 6,3 bar (90 psi), medida na entrada de ar com o aparelho ligado.

Ligar e desligar

Caso o aparelho não tiver sido utilizado por um longo período de tempo, e então não funcione, deve-se interromper o abastecimento de ar e girar manualmente o encabeadouro **1**. Assim serão removidas eventuais aderências.



Desligue o aparelho no caso de uma interrupção de abastecimento de ar ou redução da pressão de funcionamento. Controle a pressão de funcionamento e recolque em funcionamento com a pressão ideal de funcionamento.

O aparelho é ligado e desligado através da ligação ou interrupção do abastecimento de ar.

Instruções para o trabalho

Antes de todos trabalhos no aparelho deve-se interromper o abastecimento de ar.

Sentido de rotação

De acordo com o sentido de rotação desejado, o abastecimento de ar ao bocal de mangueira esquerdo ou direito.

Cargas que ocorrerem de repente, produzem uma forte redução do número de rotação ou a parada completa, mas não danificam o motor.

Tipo 0 607 953 308 / ... 309 / ... 310 /

... 311 / ... 312 / ... 326

Tipo 0 607 954 304 / ... 305

➡ **Marcha à direita:**

Ligar a mangueira de entrada de ar fresco à ligação da mangueira **3**.



No caso de um binário alto é necessária uma força de reacção igualmente alta.

Com um dispositivo de aperto na área **2**, será possível absorver esta contra-força de melhor forma. Assegure-se de que o punho adicional ou o dispositivo de aperto segurem o aparelho de forma firme e segura.

Tipo 0 607 953 313 / ... 314 / ... 315 /

... 316 / ... 317

Tipo 0 607 954 306 / ... 307

➡ **Marcha à direita:**

Ligar a mangueira de entrada de ar fresco à ligação da mangueira **3**.

➡ **Marcha à esquerda:**

Ligar a mangueira de entrada de ar fresco à ligação da mangueira **4**.



No caso de um binário alto é necessária uma força de reacção igualmente alta.

Com um dispositivo de aperto na área **2**, será possível absorver esta contra-força de melhor forma. Assegure-se de que o punho adicional ou o dispositivo de aperto segurem o aparelho de forma firme e segura.

Binário

O binário é controlado através da pressão de funcionamento.

O número de rotações em vazio indicado ajusta-se com o silenciador ligado. Retirando o silenciador, será necessário controlar o número de rotações. Um número de rotações sobreelevado pode ser reduzido ao número de rotações nominal com uma válvula de estrangulamento.

Números de rotações sobreelevados provocam um ruído desnecessário e reduzem a durabilidade do aparelho.

Liberar o ar evacuado

Após remover o silenciador **5**, poderá evacuar ar conectando uma mangueira à saída de ar.

Vantagens:

- Redução de ruído,
- nenhuma poluição do local de trabalho devido à poeira,
- evacuação do ar gasto.



Manutenção e limpeza

Antes de todos os trabalhos no aparelho intermpa o abastecimento de ar.

Mantenha o aparelho e o encabadoiro sempre limpos.

Caso o aparelho venha a apresentar falhas, apesar de cuidadosos processos de fabricação e de controlo de qualidade, deve ser reparado em um serviço técnico autorizado para aparelhos eléctricos BOSCH.

No caso de informações e encomendas de acessórios indique por favor sem falta o número de encomenda de 10 algarismos do aparelho.

Lubrificar



Lubrificante:
Lubrificante especial para engranagens 225 ml . . . 3.605 430 009
Sóleo para motores SAE 10/SAE 20

Lavar a engrenagem com benzina de lavagem primeiramente apos aprox. 150 horas de funcionamento, em seguida a cada 300 horas de funcionamento e lubrificar com o lubrificante especial para engranagens.

Estes trabalhos são efectuados rapida e seguramente em uma oficina especializada Bosch.

Elimine os lubrificantes e materiais de limpeza de maneira ecologica. Respeite as directivas oficiais.

Garantia

Prestamos garantia para aparelhos Bosch de acordo com as disposições legais/especificas do pais (comprovação através da factura ou da guia de remessa).

Avarias provenientes de desgaste natural, sobrecarga ou má utilização não são abrangidas pela garantia. Em caso de reclamação enviar o aparelho, **sem ser desmontado**, ao fornecedor ou a um serviço de assistência técnica autorizado Bosch Ferramentas Electricas.

Protecção do meio-ambiente

Reciclagem de matérias primas em vez de eliminação de lixo



Recomenda-se sujeitar o aparelho, os acessórios e a embalagem a uma reutilização ecológica.

Estas instruções foram manufacturadas com papel reciclável isento de cloro.



Parceiro de ferramentas industriais

ANICETO SILVA
Rua Delfin Ferreira 421

4022 Porto
☎ (03 51) 2-6 17 60 51
Fax (03 51) 2-6 10 30 19

HIDROMAC

Av. Columbano
Bord. Pnh. 84-C
1000 Lisboa

☎ (03 51) 1-7 26 30 11
Fax (03 51) 1-7 26 95 25

Declaração do produtor

Declaração do produtor de acordo com 98/37/CE:

Este produto é destinado exclusivamente à montagem em outra máquina ou à montagem com uma, ou mais máquinas. O funcionamento é proibido, até que a conformidade do produto final seja determinada pelas disposições das directivas 98/37/CE.

Dr. Gerhard Felten

Dr. Eckerhard Strötgen

ppa. Felten i.V. Strötgen

Robert Bosch GmbH, Geschäftsbereich Elektrowerkzeuge



Indicações de segurança para aparelhos de ar comprimido

Atenção! Ao utilizar aparelhos de ar comprimido, deverão ser observadas as seguintes medidas de segurança, como protecção contra risco de acidentes e lesões. Por favor, leia e siga estas indicações, antes de utilizar o aparelho.

- 1. Mantenha o seu local de trabalho arrumado e em ordem**
Desordem na área de trabalho aumenta o risco de acidentes.
- 2. Considere as influências ambientais**
Providencie uma boa iluminação. Não trabalhe em áreas com risco de explosões.
- 3. Mantenha crianças afastadas da área de trabalho**
Mantenha outras pessoas afastadas da área de trabalho.
- 4. Guarde os aparelhos e as ferramentas em local seguro**
Aparelhos e ferramentas de aplicação que não estão sendo utilizados, devem ser guardados em local seco, fechado e fora do alcance de crianças.
- 5. Controle do abastecimento de ar**
Controle regularmente o abastecimento de ar. Todos os equipamentos, tubulações de ligação e mangueiras devem ser apropriados para a pressão e para a quantidade de ar necessária. Proteja a mangueira contra dobras, estreitamentos, calor e cantos afiados. Mangueiras e acoplamentos danificados devem ser reparados imediatamente e deverão ser apertadas todas as bracedeiras de mangueiras. Um abastecimento de ar danificado pode provocar uma mangueira de ar comprimido que golvele em sua volta, provocando lesões. O levantamento de pó ou de aparas pode levar a graves lesões nos olhos.
- 6. Utilize ferramentas apropriadas**
Não utilize aparelhos desnadamente fracos ou ferramentas de adaptação para trabalhos pesados. Não utilize aparelhos para fins e trabalhos, para os quais não são apropriados.
- 7. Use roupa de trabalho apropriada**
Não use roupas largas ou jóias. Estas podem ser prendidas por peças móveis. No caso de cabelos longos, deverá utilizar uma rede para cabelos. Para trabalhos ao ar livre, é recomendável utilizar sapatos anti-derrapantes.
- 8. Use um óculos de protecção**
Utilize uma máscara de protecção contra pó, no caso de trabalhos que produzam pó.
- 9. Fixe a ferramenta a ser trabalhada**
Utilize dispositivos de tensão ou um torno de bancada, para fixar a peça a ser trabalhada. Desta forma estará mais firme do que se for segurado com suas mãos e possibilita o comando da máquina com ambas as mãos.
- 10. Mantenha uma distância de segurança**
Evite uma postura anormal. Mantenha uma posição segura, e mantenha sempre o equilíbrio.
- 11. Trate o seu aparelho e as ferramentas com cuidado**
Mantenha o seu aparelho limpo e as ferramentas sempre afiadas. Para poder trabalhar bem e seguramente. Siga as direcções de manutenção e as indicações para a substituição de ferramenta. Mantenha os punhos secos e livres de óleo e gordura.
- 12. Interromper o abastecimento de ar**
Deverá interromper o abastecimento de ar, caso não utilizar o aparelho e antes da manutenção, assim como antes da substituição de ferramentas.
- 13. Não deixe nenhuma chave de ferramenta introduzida**
Antes de ligar o aparelho, controle se a chave e as ferramentas de ajustes foram retiradas do aparelho.
- 14. Evite um arranque involuntário**
Jamais transporte aparelhos conectados ao abastecimento de ar, com o dedo no interruptor. Assgure-se de que o aparelho esteja desligado ao ligá-lo ao abastecimento de ar.
- 15. Esteja sempre atento**
Observe o seu trabalho. Trabalhe com bom senso. Não utilize o aparelho quando não estiver bem concentrado.
- 16. Controle se o seu aparelho apresenta danos**
Antes de utilizar o aparelho, deverá controlar atenciosamente se os dispositivos de segurança ou se peças levemente danificadas ainda estão funcionando correctamente e de acordo com as disposições. Controle se a função das peças móveis está em ordem, se não emperram ou se nenhuma peça está danificada. Todas as peças devem estar correctamente montadas e todas as condições devem ser cumpridas, para assegurar o funcionamento perfeito do aparelho. Dispositivos de protecção e peças danificados devem ser reparados de forma especializada por uma oficina de serviço pós venda ou substituídos, se não houver nenhuma outra indicação nas instruções de serviço. Interruptores danificados devem ser substituídos numa oficina de serviço pós venda. Não utilize aparelhos, nos quais não é possível accionar o interruptor de ligar/desligar.
- 17. Atenção!**
Para a sua própria segurança, utilize apenas acessórios e aparelhos adicionais, que são indicados na instrução de serviço. A utilização de ferramentas de introdução ou acessórios não recomendados na instrução de serviço ou no catálogo, pode significar um risco de lesões pessoais.
- 18. Reparações apenas por pessoal especializado**
Este aparelho de ar comprimido corresponde às principais disposições de segurança. Reparações só devem ser realizadas por um especialista, caso contrário a pessoa a operar o aparelho pode sofrer acidentes.

Guarde bem estas indicações de segurança.

**Dati tecnici**

1

Motore pneumatico di montaggio 180 W

Codice di ordinazione 0 607 953 308	... 309	... 310	... 311	... 312	... 313
Numero di giri a vuoto	[min ⁻¹] 820	1 250	1 700	3 000	5 400	660
Coppia di serraggio	[Nm] 8,0	5,3	3,7	2,1	1,1	7,5
Potenza resa	[W] 180	180	180	180	180	160
Funzionamento reversibile	↔	↔	↔	↔	↔	↔
Mandrino portautensile	3/8"-24 UNF-2A ●	●	●	●	●	●
Pressione nominale	[bar/psi] 6,3/90	6,3/90	6,3/90	6,3/90	6,3/90	6,3/90
Collegamento per tubo	G 1/8"	G 1/8"	G 1/8"	G 1/8"	G 1/8"	G 1/8"
Luce larghezza del tubo	[mm] 6	6	6	6	6	6
Consumo di aria sotto carico	[l/s] 6,0	6,0	6,0	6,0	6,0	7,2
Peso (senza accessori) ca.	[kg] 0,58	0,58	0,58	0,50	0,50	0,64

Motore pneumatico di montaggio 180 W

Codice di ordinazione 0 607 953 314	... 315	... 316	... 317	... 326
Numero di giri a vuoto	[min ⁻¹] 1 050	1 400	2 600	4 600	2 000
Coppia di serraggio	[Nm] 5,1	3,5	2,0	1,0	3,1
Potenza resa	[W] 160	160	160	160	180
Funzionamento reversibile	↔	↔	↔	↔	↔
Mandrino portautensile	3/8"-24 UNF-2A ●	●	●	●	●
Pressione nominale	[bar/psi] 6,3/90	6,3/90	6,3/90	6,3/90	6,3/90
Collegamento per tubo	G 1/8"	G 1/8"	G 1/8"	G 1/8"	G 1/8"
Luce larghezza del tubo	[mm] 6	6	6	6	6
Consumo di aria sotto carico	[l/s] 7,2	7,2	7,2	7,2	6,0
Peso (senza accessori) ca.	[kg] 0,64	0,64	0,56	0,56	0,58

3 609 929 498 • 99.10

Motore pneumatico di montaggio 120 W

Codice di ordinazione 0 607 954 304	... 305	... 306	... 307
Numero di giri a vuoto	[min ⁻¹] 2 200	4 900	1 850	4 100
Coppia di serraggio	[Nm] 2,1	1,0	2,0	0,9
Potenza resa	[W] 120	120	100	100
Funzionamento reversibile	↔	↔	↔	↔
Mandrino portautensile	3/8"-24 UNF-2A ●	●	●	●
Pressione nominale	[bar/psi] 6,3/90	6,3/90	6,3/90	6,3/90
Collegamento per tubo	G 1/8"	G 1/8"	G 1/8"	G 1/8"
Luce larghezza del tubo	[mm] 6	6	6	6
Consumo di aria sotto carico	[l/s] 4,5	4,5	5,0	5,0
Peso (senza accessori) ca.	[kg] 0,37	0,32	0,37	0,32



Elementi della macchina

- 1 Mandrino portautensile
- 2 Área de aperto
- 3 Raccordo aria per funzionamento destrorso
- 4 Raccordo aria per funzionamento sinistrorso
- 5 Scarico dell'aria con silenziatore*

*Accessori

Accessori illustrati o descritti non fanno necessariamente parte del volume di consegna.

Accessori

Collegamento per tubo. 3 603 386 002
 Silenziatore. 3 607 000 016
 Flangia di fissaggio 180 W. 3 605 700 044
 Flangia di fissaggio 120 W. 3 605 700 043
 Lubrificante speciale
 per trasmissione 225 ml. 3 605 430 009



Per la Vostra sicurezza



E' possibile lavorare con la macchina senza incorrere in pericoli soltanto dopo aver letto completamente le istruzioni per l'uso, l'opuscolo avvertenze per la sicurezza e seguendo rigorosamente le istruzioni in esse contenute.

È indispensabile rispettare anche le indicazioni riportate nel capitolo *Indicazioni di sicurezza per utensili ad aria compressa*.

Fatevi istruire praticamente prima di passare all'operazione pratica.

- **Interruzione dell'alimentazione dell'aria**

In caso di non utilizzo, prima di operazioni di manutenzione e prima di sostituire utensili ad innesto, interrompere sempre l'alimentazione dell'aria.

- Non avvicinare mai le mani al mandrino portautensile né agli utensili ad innesto ancora in rotazione. In caso di rottura dell'utensile ad innesto, le schegge che vengono scaraventate per aria comportano un serio pericolo per l'incolumità di persone.

- **Attenzione in caso di luoghi operativi con poco spazio**

Per via di possibili scatti di reazione vi è il pericolo di rimanere incastrati oppure di schiacciare parti del corpo.

- **Non sovraccaricare la macchina.**

Operare con la pressione nominale indicata. Tutti gli strumenti, le tubazioni di collegamento ed i tubi devono essere adatti alla rispettiva pressione ed alla quantità di aria necessaria.

- Montando il motore di montaggio in un dispositivo di serraggio utilizzare la flangia di serraggio e rispettare le indicazioni di sicurezza relativa al dispositivo di serraggio.
- Non sovraccaricare il campo di serraggio del motore di montaggio.
- La Bosch garantisce un perfetto funzionamento della macchina soltanto se vengono utilizzati accessori originali.

Alimentazione dell'aria

Per poter proteggere l'apparecchio da danneggiamenti, sporcizia e formazione di ruggine, l'aria alimentata deve essere libera da corpi estranei e da umidità. **È necessario utilizzare un'unità di preparazione aria.**

Tutti gli strumenti, tubazioni di collegamento e tubi devono essere compatibili con la pressione e la quantità di aria necessaria. Evitare una qualunque riduzione dei tubi di alimentazione.

Evitare di restringere i tubi di alimentazione premendoli, piegandoli oppure tirandoli!

In caso di dubbi, verificare con un manometro la pressione all'entrata dell'aria mentre l'apparecchio è in funzione.

Unità di preparazione aria

L'unità di preparazione aria garantisce un perfetto funzionamento degli utensili ad aria compressa.

- E' composta di tre componenti principali:
- filtro con separatore dell'acqua,
 - valvola di riduzione della pressione con manometro,
 - lubrificatore a nebbia d'olio.

Sostanza lubrificante nel lubrificatore a nebbia d'olio: olio per motori SAE 10/SAE 20.

Non usare petrolio o olio diesel.

Impostare il lubrificatore a nebbia in maniera tale che allo scarico dell'aria si forma un fine velo di lubrificante. Osservare le istruzioni per l'uso dell'unità di preparazione aria.

Prima della messa in servizio

Fissare il motore di montaggio soltanto nel campo di serraggio **2** ed utilizzare possibilmente il completo campo di serraggio. Più si riduce il campo di serraggio, tanto maggiore è l'effetto delle forze di serraggio.

- Non sovraccaricare il campo di serraggio del motore di montaggio.



Montaggio

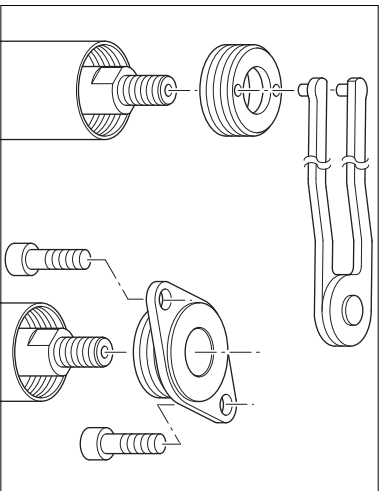

Utilizzando una chiave a gancio, svitare l'anello filettato (filatura sinistrorsa) e la flangia di fissaggio. Il motore di montaggio può essere montato alla flangia di fissaggio utilizzando due viti applicate al dispositivo di serraggio.

Istruzioni per il lavoro

Prima di una qualunque operazione di lavoro all'apparecchio è necessario staccare l'alimentazione dell'aria.

Senso di rotazione

A seconda del senso di rotazione desiderato, collegare l'alimentazione dell'aria al raccordo per tubo destro oppure sinistro.

Carichi improvvisi producono un forte abbassamento del numero di giri oppure inattività senza comunque provocare danni al motore.

Tipo 0 607 953 308 / ... 309 / ... 310 /

... 311 / ... 312 / ... 326

Tipo 0 607 954 304 / ... 305

Funzionamento destrorso:

Collegare il tubo dell'aria di alimentazione al raccordo **3**.



In caso di forti momenti di coppia si rivela necessario l'esercizio di una controforza rispettivamente alta.

Utilizzando un dispositivo di serraggio applicato nella zona **2**, è possibile contenere meglio questa forza contraria.

Accertarsi che l'impugnatura supplementare oppure il dispositivo di serraggio tenga la macchina in modo sicuro e ben fissa.

Tipo 0 607 953 313 / ... 314 / ... 315 /

... 316 / ... 317

Tipo 0 607 954 306 / ... 307

Funzionamento destrorso:

Collegare il tubo dell'aria di alimentazione al raccordo **3**.

Funzionamento sinistrorso:

Collegare il tubo dell'aria di alimentazione al raccordo **4**.



In caso di forti momenti di coppia si rivela necessario l'esercizio di una controforza rispettivamente alta.

Utilizzando un dispositivo di serraggio applicato nella zona **2**, è possibile contenere meglio questa forza contraria.

Accertarsi che l'impugnatura supplementare oppure il dispositivo di serraggio tenga la macchina in modo sicuro e ben fissa.

Messa in servizio

La macchina lavora in maniera ottimale con una sovrappressione di 6,3 bar (90 psi), misurata all'entrata dell'aria e con la macchina in azione.

Avviare ed arrestare

Se la macchina non si mette in moto, p.e. dopo un lungo periodo di riposo, interrompere l'alimentazione dell'aria e girare a mano il mandrino **1**. In questa maniera si eliminano forze di adesione.



In caso di un'interruzione dell'alimentazione dell'aria compressa oppure in caso di una riduzione della pressione d'esercizio, disinserire la macchina, controllare la pressione d'esercizio e riavviare la macchina quando si sarà di nuovo raggiunta un'ottimale pressione operativa.

La macchina può essere inserita-disinserita attraverso l'inserimento oppure l'interruzione dell'alimentazione dell'aria.

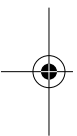
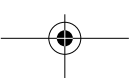
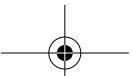



Coppia di serraggio

La coppia di serraggio può essere regolata attraverso la pressione di esercizio.

Il numero di giri a vuoto indicato viene ad impostarsi automaticamente se viene montato il silenziatore. Se si toglie il silenziatore, è necessario verificare il numero dei giri. Un numero di giri troppo elevato va ridotto al valore nominale dei giri impiegando una valvola di strozzamento.

Un numero di giri troppo elevato provoca rumori inutili ed abbrevia la durata dell'apparecchio.

Asportazione dell'aria di scarico

Smontando il silenziatore **5** e collegando un tubo flessibile all'uscita aria è possibile asportare l'aria di scarico.

Vantaggi:

- abbassamento del rumore,
- si evita di sporcare la stazione di lavoro sollevando la polvere,
- canalizzazione dell'aria di scarico.

Garanzia

Per gli apparecchi Bosch forniamo una garanzia conforme alle specifiche disposizioni di legge vigenti nel rispettivo Paese di vendita (certificazione a mezzo di fattura o bolla di consegna).

Guasti derivanti da normale usura, da sovraccarico oppure da uso improprio dell'apparecchio sono esclusi da ogni prestazione di garanzia.

La garanzia è subordinata alla compilazione completa di questo certificato.

Modello: _____

Data di acquisto: _____

Rivenditore (Timbro e firma): _____

Si accettano reclami solo se l'apparecchio viene inviato, **non smontato**, al fornitore oppure a una officina del Servizio Assistenza Clienti Bosch per utensili elettrici.

Manutenzione e pulizia

Prima di un qualunque intervento sulla macchina, staccare l'alimentazione dell'aria.

Mantenere sempre pulita la macchina ed il mandrino portautensile.

Se nonostante gli accurati procedimenti di produzione e di controllo la macchina dovesse guastarsi, la riparazione va fatta effettuata da un punto di assistenza autorizzato per gli utensili Bosch.

Per ogni tipo di richiesta o di ordinazione di pezzi di ricambio, è indispensabile comunicare sempre il codice di ordinazione a dieci cifre riportato sulla targhetta di fabbricazione della macchina.



Lubrificazione

Lubrificante:

Lubrificante speciale per trasmissione 225 ml . . . 3 605 430 009
Olio per motori SAE 10/SAE 20

Dopo ca. 150 ore di esercizio, lavare per la prima volta gli ingranaggi con benzina e lubrificarli con apposito lubrificante; in seguito ripetere l'operazione ogni 300 ore di esercizio.

Questo tipo di lavoro viene eseguito in maniera veloce ed affidabile da ogni Centro di assistenza Clienti Bosch.

Smaltire lubrificanti e detergenti rispettando l'ambiente. Rispettare le prescrizioni legislative in merito.

Avvertenze per la protezione dell'ambiente

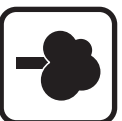

Recupero di materie prime, piuttosto che smaltimento di rifiuti

Apparecchio, accessori ed imballaggio dovrebbero essere inviati ad una riutilizzazione ecologica.

Queste istruzioni sono stampate su carta riciclata sbiancata senza cloro.

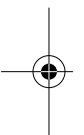
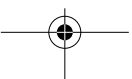

**Il Vostro partner per
l'industria****Italia**

R.A.M.U.
Via Bruni 28-30
25 100 Brescia ☎ 030/4 65 11

FRAU
Ix° Strada, 26 Z.I.
35 129 Padova ☎ 049/77 33 66

ORE
Via Portogallo, 27
47 037 Rimini ☎ 0541/74 10 03

SORCI
Via de Fontanelle, 24
50 944 Fobriano ☎ 0732/48 02

ALE.FRA.
Pistoiese, 583
50 010 S. Dominio
Campi Bisenzio ☎ 055/8 99 96 58

OPL
Viale Treviso, 13-B
33 170 Pordenone ☎ 0434/57 27 57
Fax 0434/57 27 50

REAL SYSTEM
Via Domenico Bazzano, 8
90 123 Palermo ☎ 091/39 30 13
Fax 091/39 20 05

U.Sa.pi
Via Lecco, 43
24 035 Mozzo ☎ 035/46 23 34
Fax 035/61 58 39

FERUMAC
Via G. Battista Vico, 54-56
20 100 Corrado ☎ 02/93 56 80 27
Fax 02/9 36 39 39

AET
Via Delle Lose, 19
10 092 Belasco ☎ 011/3 97 25 44
Fax 011/3 97 27 65

SAMI
Via Marvin Gelber, 15
66 013 Scalo di Chieti ☎ 0871/56 55 09
Fax 0871/56 61 18

REVERBERI
Via Piccardi, 8-8A
42 100 Reggio Emilia ☎ 0522/30 30 83
Fax 0522/38 18 52

RIVA & BRUTI
Via Casmedi, 58
22 049 Valnadrera Como ☎ 0341/58 13 74
Fax 0341/58 13 74

U. VARESINA
Via Cadore, 105
21 100 Varese ☎ 0332/81 20 34

TEMA
Via L. Gaio, 14
20 151 Milano ☎ 02/38 00 12 45
☎ 03/31 46 71 11
Fax 03/31 46 72 22

Swizzera

Robert Bosch AG
Kundendienst Elektrowerkzeuge
Industriestrasse 31
81 12 Oetflingen ☎ Servizio (01) 8 47 16 16
Consulente per la clientela:
☎ Numero Verde (0 800) 55 11 55

**Dichiarazione di conformità
del costruttore**

Dichiarazione di conformità del costruttore alla norma CE 98/37:

Questo prodotto è idoneo esclusivamente al montaggio in un'altra macchina o per essere montata insieme ad un'altra macchina od insieme ad altre macchine. La messa in esercizio è proibita fintanto che non sia stata determinata la conformità del prodotto finale con le direttive della normativa CE 98/37.

Dr. Gerhard Felten Dr. Eckehard Strötgen

ppa. Felten i.v. Strötgen

Robert Bosch GmbH, Geschäftsbereich Elektrowerkzeuge

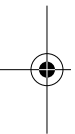



Indicazioni di sicurezza per utensili ad aria compressa



- Attenzione!** Utilizzando macchine pneumatiche, al fine di evitare il pericolo di infortuni è necessario attenersi alle seguenti misure basilari di sicurezza.
- Prima di utilizzare la macchina, leggere attentamente le seguenti indicazioni e rispettarle.**
- Mantenere costantemente pulita la zona di operazione**
Disordinare nel campo di operazione comporta pericolo di incidenti.
 - Tenere in considerazione gli infussi ambientali**
Assicurarsi una buona illuminazione. Non lavorare in ambienti soggetti al pericolo di esplosioni.
 - Non lasciar avvicinare bambini al campo di operazione**
Non lasciar avvicinare altre persone al campo di operazione.
 - Conservare la macchina e gli utensili in luogo sicuro**
Conservare le macchine e gli utensili non utilizzati in un locale asciutto e chiuso in modo da non essere accessibili a bambini.
 - Controllare l'alimentazione dell'aria**
Controllare regolarmente l'alimentazione dell'aria. Tutti gli strumenti, le tubazioni di collegamento ed i tubi devono essere adatti alla rispettiva pressione ed alla quantità di aria necessaria. Evitare di piegare oppure di restringere il tubo e proteggerlo da calore e da spigoli taglienti. Far riparare immediatamente tubi e giunti danneggiati. Stringere bene le fascette per tubi flessibili.
Un'alimentazione difettosa dell'aria può far spazzare in modo incontrollato il tubo per l'aria compressa provocando un serio pericolo di incidenti. Sollevando accidentalmente polvere e trucioli vi è il pericolo di farne gravemente gli occhi.
 - Utilizzare sempre macchine ed utensili adatti**
Mai utilizzare macchine oppure utensili che siano troppo vecchi per lavori di natura pesante. Non utilizzare macchine per scopi e lavori per cui non ne sia stata espressamente dichiarata l'idoneità.
 - Indossare abbigliamento idoneo**
Non portare vestiti larghi né gioielli che potrebbero offrire una presa alle parti mobili della macchina. In caso di capelli lunghi è necessario portare un'adatta protezione per i capelli. In caso di lavori all'aperto, si consiglia di portare scarpe che non scivolano.
 - Portare occhiali di protezione**
Portare la mascherina di protezione contro la polvere in caso di lavorazione di materiali a forte produzione di polvere.
 - Assicurare il pezzo in lavorazione**
Per fissare il pezzo in lavorazione, utilizzare dispositivi di serraggio oppure una morsa a vite. In questo modo il pezzo viene fissato in maniera sicura e sarà possibile operare con la macchina utilizzando entrambe le mani.
 - Prendere una sicura posizione di lavoro**
Evitare strane posizioni di lavoro. Prendere una sicura posizione di lavoro e mantenere sempre l'equilibrio.
 - Avere cura della macchina e degli utensili**
Mantenere sempre pulita la macchina ed avere cura che gli utensili ad innesto siano ben affilati in modo da poter garantire sicure ed ottimali prestazioni. Rispettare le prescrizioni relative alla manutenzione e le indicazioni che riguardano la sostituzione degli utensili. Mantenere le impugnature sempre asciutte e libere da olio e grasso.
 - Interruzione dell'alimentazione dell'aria**
In caso di non utilizzo, prima di operazioni di manutenzione e prima di sostituire utensili ad innesto, interrompere sempre l'alimentazione dell'aria.
 - Mai lasciare inserite chiavi di servizio**
Prima di avviare la macchina, assicurarsi che siano state tolte le chiavi di servizio e gli utensili utilizzati per operazioni di regolazione.
 - Evitare avviamenti involontari**
Mai trasportare macchine collegate all'aria compressa tenendo il dito sull'interruttore. Prima di collegare la macchina all'aria compressa, assicurarsi che la macchina sia disinserita.
 - Operare sempre con estrema attenzione**
Controllare sempre l'andamento del lavoro che state facendo. Procedere sempre con estrema cautela. Mai utilizzare la macchina se non ci si sente perfettamente concentrati.
 - Controllare se la macchina sia difettosa**
Prima di utilizzare la macchina, controllare accuratamente i dispositivi di sicurezza oppure parti leggermente danneggiate accertandosi che funzionino perfettamente e secondo le rispettive modalità previste. Controllare se le parti mobili funzionano correttamente, se non bloccano ed accertarsi che nessuna delle parti sia danneggiata. Tutte le parti devono essere montate correttamente e corrispondere perfettamente a tutte le condizioni previste a garanzia di un perfetto funzionamento della macchina. Parti e dispositivi di protezione danneggiati devono essere riparati a regola d'arte presso un'officina autorizzata ad eseguire lavori di servizio oppure devono essere sostituiti a meno che nei manuali delle istruzioni per l'uso non venga espressamente prevista una soluzione di altro tipo. Mai utilizzare macchine se l'interruttore di avvio/arresto dovesse essere difettoso.
 - Attenzioni!**
Per la Vostra sicurezza personale, utilizzare esclusivamente apparecchiature supplementari ed accessori riportati nel manuale delle istruzioni per l'uso. Un utilizzo improprio di utensili ad innesto oppure di accessori di tipo diverso da quelli raccomandati nel manuale delle istruzioni per l'uso oppure nel catalogo, può comportare un serio pericolo per la Vostra incolumità.
 - Riparazioni solo a cura di personale specializzato**
Questa macchina pneumatica corrisponde alle pertinenti prescrizioni di sicurezza.
Interventi di riparazione possono essere eseguiti soltanto da personale specializzato. In caso contrario l'utente viene a creare situazioni con serio pericolo di incidenti.
- Conservare bene le presenti Indicazioni di sicurezza.**

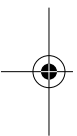
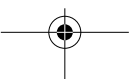
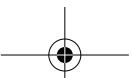

**Technische gegevens**

NL

**Perslucht-inbouwmotor 180 W**

Bestelnummer 0 607 953 308	... 309	... 310	... 311	... 312	... 313
Toerental onbelast	[min ⁻¹] 820	1 250	1 700	3 000	5 400	660
Afslagmoment	[Nm] 8,0	5,3	3,7	2,1	1,1	7,5
Afgegeven vermogen	[W] 180	180	180	180	180	160
Draairichting	↺	↺	↺	↺	↺	↺
Gereedschapsopname	3/8"-24 UNF-2A ●	●	●	●	●	●
Nominale druk	[bar/psi] 6,3/90	6,3/90	6,3/90	6,3/90	6,3/90	6,3/90
Slangaansluiting	G 1/8"	G 1/8"	G 1/8"	G 1/8"	G 1/8"	G 1/8"
Binnenwerkse slangdiameter	[mm] 6	6	6	6	6	6
Luchtverbruik bij belasting	[l/s] 6,0	6,0	6,0	6,0	6,0	7,2
Gewicht (zonder toebehoren) ca.	[kg] 0,58	0,58	0,58	0,50	0,50	0,64

Perslucht-inbouwmotor 180 W

Bestelnummer 0 607 953 314	... 315	... 316	... 317	... 326
Toerental onbelast	[min ⁻¹] 1 050	1 400	2 600	4 600	2 000
Afslagmoment	[Nm] 5,1	3,5	2,0	1,0	3,1
Afgegeven vermogen	[W] 160	160	160	160	180
Draairichting	↺	↺	↺	↺	↺
Gereedschapsopname	3/8"-24 UNF-2A ●	●	●	●	●
Nominale druk	[bar/psi] 6,3/90	6,3/90	6,3/90	6,3/90	6,3/90
Slangaansluiting	G 1/8"	G 1/8"	G 1/8"	G 1/8"	G 1/8"
Binnenwerkse slangdiameter	[mm] 6	6	6	6	6
Luchtverbruik bij belasting	[l/s] 7,2	7,2	7,2	7,2	6,0
Gewicht (zonder toebehoren) ca.	[kg] 0,64	0,64	0,56	0,56	0,58

3 609 929 498 • 99.10

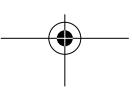

**Perslucht-inbouwmotor 120 W**

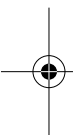
Bestelnummer 0 607 954 304	... 305	... 306	... 307
Toerental onbelast	[min ⁻¹] 2 200	4 900	1 850	4 100
Afslagmoment	[Nm] 2,1	1,0	2,0	0,9
Afgegeven vermogen	[W] 120	120	100	100
Draairichting	↺	↺	↺	↺
Gereedschapsopname	3/8"-24 UNF-2A ●	●	●	●
Nominale druk	[bar/psi] 6,3/90	6,3/90	6,3/90	6,3/90
Slangaansluiting	G 1/8"	G 1/8"	G 1/8"	G 1/8"
Binnenwerkse slangdiameter	[mm] 6	6	6	6
Luchtverbruik bij belasting	[l/s] 4,5	4,5	5,0	5,0
Gewicht (zonder toebehoren) ca.	[kg] 0,37	0,32	0,37	0,32





Onderdelen van het apparaat

- 1 Gereedschapsopname
- 2 Inspanbereik
- 3 Slangansluiting voor rechtsom draaien 
- 4 Slangansluiting voor linksom draaien , alleen bij machines met rechts- en linksdraaien 
- 5 Luchtuitlaat met geluiddemper*

*Toebehoren

Niet al het afgebeelde of beschreven toebehoren wordt standaard meegeleverd.

Toebehoren

Adapter	3 603 386 002
Geluiddemper	3 607 000 016
Bevestigingsfiens 180 W	3 605 700 044
Bevestigingsfiens 120 W	3 605 700 043
Speciaal transmissievet 225 ml	3 605 430 009



Voor uw veiligheid



Veilig werken met de machine is alleen mogelijk indien u de gebruiksaanwijzing en de veiligheidsvoorschriften volledig leest en de daarin gegeven voorschriften strikt opvolgt.

Bovendien moet het gedeelte Veiligheidsvoorschriften voor persluchtgereedschappen in acht worden genomen.

Laat u voor het eerste gebruik praktisch instrueren.

- **Onderbreek de luchttoevoer**
Onderbreek de luchttoevoer wanneer u de machine niet gebruikt, voor het uitvoeren van onderhoud aan de machine en voor het wisselen van toebehoren.
- Houd uw handen uit de buurt van de ronddraaiende gereedschapsopname en het aangebrachte inzetgereedschap. Bij het breken van het inzetgereedschap kunnen wegvliegende splinters verwondingen veroorzaken.
- **Voorzichtig bij werkomstandigheden met weinig ruimte**
Door reactiemomenten en daardoor veroorzaakt vastklemmen of vastknellen kunnen verwondingen optreden.
- **Overbelast de machine niet.**
Werk met de aangegeven nominale druk. Alle armaturen, verbindingselementen en slangen moeten geschikt zijn voor de druk en de vereiste luchttoevoerbaarheid.



- Gebruik bij het inspannen van de inbouwmotor de bevestigingsfiens. Neem de veiligheidsvoorschriften van de inspanvoorziening in acht.

- Overbelast het inspanbereik van de inbouwmotor niet.
- Bosch kan slechts een correcte werking van de machine garanderen wanneer origineel toebehoren wordt gebruikt.

Persluchttoevoer

De toegevoerde lucht mag geen deeltjes of vocht bevatten om de machine te beschermen tegen beschadiging; vervulling en roestvorming.

Het gebruik van een luchtverzorgingseenheid is noodzakelijk.

Alle armaturen, verbindingselementen en slangen moeten zijn aangelegd in overeenstemming met de vereiste hoeveelheid perslucht.

Voorom vernauwingen van de aanvoertleidingen bijv. door drukken, knikken of trekken!

In geval van twiifel de druk bij de luchttoevoeropening van de machine controleren met een manometer.

Luchtverzorgingseenheid

De luchtverzorgingseenheid waarborgt een probleemloze werking van persluchtgereedschappen.

De eenheid bestaat uit drie hoofdbestanddelen:

- Filter met waterafscheider,
- Drukreducerenventiel met manometer,
- Olienevelaar.

Smeermiddel in de olienevelaar: motorolie SAE 10/SAE 20.

Geen petroleum of dieselolie gebruiken.

Olienevelaar zo instellen dat bij de luchtafvoeropening een dunne smeerfilm ontstaat.

Gebruiksaanwijzing van de onderhoudseenheid in acht nemen.





Montage

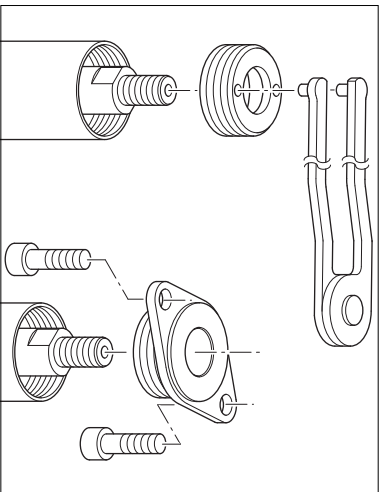

Draai de schroefdraadring met een haaksleutel naar buiten (linkse schroefdraad) en draai de bevestigingsflens in. Aan de bevestigingsflens kan de inbouwmotor met twee schroeven aan de inspanvoorziening worden vastgeschroefd.

Ingebruikneming

De machine werkt optimaal bij een overdruk van 6,3 bar (90 psi), gemeten bij de luchttoevoeropening terwijl de machine in werking is.

In- en uitschakelen

Wanneer de machine niet gaat draaien, bijv. na lange tijd niet te zijn gebruikt, persluchttoevoer onderbreken en gereedschapopname **1** met de hand door-draaien. Zo wordt het vastklemmen opgeheven.



Schakel de machine uit bij een onderbreking van de luchttoevoer op bij een vermindering van de bedrijfsdruk. Controleer de bedrijfsdruk en start de machine opnieuw bij optimale bedrijfsdruk.

De machine wordt in- en uitgeschakeld door de persluchttoevoer in te schakelen of te onderbreken.

Tips voor de werkzaamheden

Onderbreek voor werkzaamheden aan de machine altijd de persluchttoevoer.

Draairichting

Sluit de luchttoevoer afhankelijk van de gewenste draairichting aan het linkse of rechte slangaansluitstuk aan.

Plotseling optredende belastingen leiden tot een scherpe daling van het toerental of stilstand, maar schaden de motor niet.

Type 0 607 953 308 / ... 309 / ... 310 / ... 311 / ... 312 / ... 326

Type 0 607 954 304 / ... 305

Rechtsom draaien: Luchtaanvoerslang aan slangaansluiting **3** aansluiten.



Bij hoge draaimomenten is een overeenkomstig grote tegenkracht noodzakelijk.

Met een inspanvoorziening in bereik **2** kan deze tegenhoudkracht beter worden opgenomen.

Zorg ervoor dat de extra handgreep of de inspanvoorziening de machine veilig en stevig vasthoudt.

Type 0 607 953 313 / ... 314 / ... 315 / ... 316 / ... 317

Type 0 607 954 306 / ... 307

Rechtsom draaien: Luchtaanvoerslang aan slangaansluiting **3** aansluiten.

Linksom draaien: Luchtaanvoerslang aan slangaansluiting **4** aansluiten.



Bij hoge draaimomenten is een overeenkomstig grote tegenkracht noodzakelijk.

Met een inspanvoorziening in bereik **2** kan deze tegenhoudkracht beter worden opgenomen.

Zorg ervoor dat de extra handgreep of de inspanvoorziening de machine veilig en stevig vasthoudt.

Draaimoment

Het draaimoment is regelbaar via de bedrijfsdruk.

Het aangegeven onbelaste toerental treedt op wanneer de geluiddemper aangesloten is. Indien de geluiddemper verwijderd wordt, moet het toerental gecontroleerd worden. Bij een te hoog toerental moet het nominale toerental worden gereduceerd.

Te hoge toerentallen veroorzaken onnodig lawaai en verkorten de levensduur van de machine.

Gebruikte lucht afvoeren

Na het verwijderen van de geluiddemper **5** kan de afvoerlucht worden afgevoerd door een slang op de luchtafvoer aan te sluiten.

Voordelen:

- minder geluid,
- geen verontreiniging van de werkomgeving door opgewaaid stof,
- afvoerlucht wordt weggeleid.

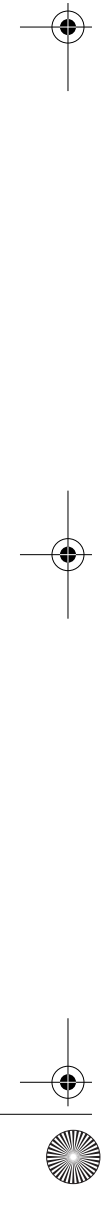
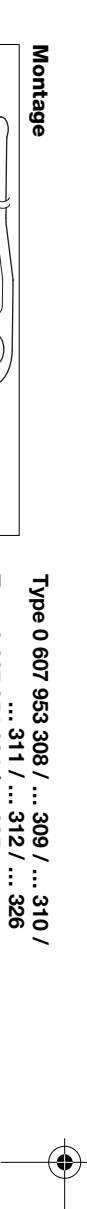
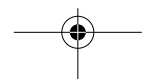



Onderhoud en reiniging

Onderbreek voor werkzaamheden aan de machine altijd de persluchttoevoer.

Machinerie en gereedschapopname altijd schoon houden.

Mocht de machine ondanks zeer zorgvuldige fabricage- en testmethoden toch defect raken, dient de reparatie door een erkend service-station voor BOSCH elektrisch gereedschap uitgevoerd te worden.

Vermeld a.u.b. bij al uw vragen en bij bestellingen van vervangingsonderdelen het 10-cijferige bestelnummer van de machine.



Smeren

Smeermiddel:
Speciaal transmissievet
225 ml. 3 605 430 009
Motorolie SAE 10/SAE 20

Transmissie voor het eerst na 150 bedrijfsuren, daarna elke 300 bedrijfsuren met wasbenzine uitwassen en met speciaal transmissievet smeren.
De Klantenservice van Bosch voert deze werkzaamheden snel en correct uit.

Ga met smeer- en reinigings middelen milieubewust om. Neem de wettelijke voorschriften in acht.

Garantie

Voor Bosch-gereedschap geven wij garantie volgens de wettelijk geïndene bepalingen (rekening of pakbon geldt als bewijs). Schade die terug te voeren is op natuurlijke slijtage, overbelasting of onoordeelkundig gebruik is van garantie uitgesloten.

Schade die door materiaal- of fabricagefouten ontstaan is, wordt gratis door levering van onderdelen of reparatie verholpen.

Reparaties kunnen alleen voor garantie in aanmerking komen wanneer het betreffende gereedschap in **volledig gemonteerde** staat wordt afgegeven of gezonden aan een erkende Bosch service-werkplaats of de importeur.

Gelijktijdig dient vermeld te worden dat aanspraak op garantie wordt gemaakt. Het volledig ingevulde garantiebewijs moet worden overlegd.

Milieubescherming

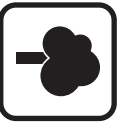

Terugninnen van grondstoffen in plaats van het weggooien van afval

Machinerie, toebehoren en verpakking dienen op een voor het milieu verantwoorde manier te worden hergebruikt.

Deze gebruiksaanwijzing is vervaardigd van chloorvrij gebleekt kringlooppapier.



Partner voor industrie-gereedschappen

Nederland

Robert Bosch B.V.
Neptunusstraat 71
2132 JP Hoofddorp
☎ (023) 565 60 00

Akkermans B.V.

Abrah. de Haanstraat 13
Postbus 129

4600 Bergen op Zoom

☎ (01640) 424 50
Fax (01640) 413 92

België

CEMAC TECHNIAIR

Afrikantlaan 289 A
9000 Gent

☎ (09) 259 02 62
Fax (09) 259 17 87

Verklaring van de fabrikant

Verklaring van de fabrikant volgens 98/37/EG:

Dit product is uitsluitend bedoeld om te worden ingebouwd in een andere machine of om samen met een andere machine of andere machines te worden gemonteerd. De ingebruikname is verboden zolang de conformiteit van het eindproduct met de bepalingen van de richtlijn 98/37/EG niet is vastgesteld.

Dr. Gerhard Feiten

Dr. Eckerhard Strötgen

ppa. Feiten i.v. Strötgen

Robert Bosch GmbH, Geschäftsbereich Elektrowerkzeuge

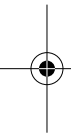
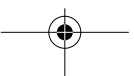
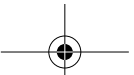



Veiligheidsvoorschriften voor persluchtgereedschappen

Let op! Bij het gebruik van persluchtgereedschappen moeten ter voorkoming van verwondingen de volgende belangrijke veiligheidsvoorschriften in acht worden genomen.
Lees deze voorschriften voordat u het gereedschap gebruikt en neem de voorschriften in acht.

- Houd uw werkomgeving opgeruimd**
Een niet-opgeruimde werkomgeving verhoogt de kans op ongevallen.
- Houd rekening met omgevingsinvloeden**
Zorg voor een goede verlichting. Werk niet in een omgeving met explosiegevaar.
- Houd kinderen uit de buurt van de werkzaamheden**
Houd andere personen uit de buurt van uw werkzaamheden.
- Bewaar machines en toebehoren op een veilige plaats**
Bewaar niet-gebruikte machines en toebehoren in een droge, afgesloten ruimte, buiten het bereik van kinderen.
- Controleer de luchttoevoer**
Controleer de luchttoevoer regelmatig. Alle armaturen, verbindingsgelidingen en slangen moeten geschikt zijn voor de druk en de vereiste luchttoevoerleid. Bescherm de slang tegen knikken, vernauwingen, hitte en scherpe randen. Laat beschadigde slangen en koppelingen onmiddellijk repareren en draai de slangklemmen stevig vast. Door een defecte luchttoevoer kan de perslucht slang gaan slaan en verwondingen veroorzaken. Opgewereld stof of spanen kunnen tot ernstige oogverwondingen leiden.
- Gebruik het juiste toebehoren**
Gebruik geen te lichte machines of voorzettegereedschappen voor zware werkzaamheden. Gebruik machines niet voor doelen en werkzaamheden waarvoor deze niet bestemd zijn.
- Draag geschikte werkkleding**
Draag geen loshangende kleding of sieraden. Deze kunnen door bewegende delen worden meegenomen. Draag een haarmet als u lang haar hebt. Bij werkzaamheden buitenshuis worden schoenen met een slipvaste zool geadviseerd.
- Draag een veiligheidsbril**
Gebruik een stormmasker bij werkzaamheden waarbij stof vrijkomt.
- Zet het werkstuk vast**
Gebruik klemmen of een bankschroef om het werkstuk vast te zetten. Het wordt dan steviger en veiliger vastgehouden dan u met uw hand kunt doen en u kunt de machine met beide handen bedienen.
- Zorg ervoor dat u stevig staat**
Voorkom een ongewone lichaamshouding. Zorg ervoor dat u stevig staat en dat u steeds in evenwicht blijft.
- Verzorg gereedschap en toebehoren zorgvuldig**
Houd uw machine schoon en uw toebehoren scherp, zodat u goed en veilig kunt werken. Houd u aan de onderhoudsvoorschriften en de aanwijzingen voor het wisselen van toebehoren. Houd de handgrepen droog en vrij van olie en vet.
- Onderbreek de luchttoevoer**
Onderbreek de luchttoevoer wanneer u de machine niet gebruikt, voor het uitvoeren van onderhoud aan de machine en voor het wisselen van toebehoren.
- Laat geen toebehorensleutel op de machine achter**
Controleer voor het inschakelen van de machine dat de sleutels en het instelgereedschap verwijderd zijn.
- Voorkom per ongeluk starten van de machine**
Draag machines die op de luchttoevoer zijn aangesloten nooit met de vinger aan de schakelaar. Controleer dat de machine bij het aansluiten op de toevoer uitgeschakeld is.
- Wees altijd attent**
Let op tijdens uw werkzaamheden. Ga met verstand te werk. Gebruik het gereedschap niet als u niet geconcentreerd bent.
- Controleer het gereedschap op beschadigingen**
Controleer voor het gebruik van het gereedschap veiligheidsvoorzieningen en licht beschadigde delen zorgvuldig op hun juiste werking volgens bestemming. Controleer of de werking van bewegende delen in orde is, of deze niet vastklemmen en of onderdelen beschadigd zijn. Alle delen moet juist gemonteerd zijn en dan alle voorwaarden voldoen om het juist functioneren van het gereedschap te waarborgen. Beschadigde veiligheidsvoorzieningen en onderdelen moeten op deskundige wijze door een klantenservice-werkplaats worden gerepareerd of vervangen, indien in de gebruiksaanwijzing niets anders is aangegeven. Beschadigde schakelaars moeten worden vervangen bij een klantenservice-werkplaats. Gebruik geen gereedschap waarvan de schakelaar niet kan worden in- en uitgeschakeld.
- Let op!**
Gebruik in verband met uw eigen veiligheid alleen toebehoren en uitbreidingsgereedschappen die in de gebruiksaanwijzing worden aangegeven. Het gebruik van andere dan in de gebruiksaanwijzing of de catalogus geadviseerde inzetgereedschappen of toebehoren kan leiden tot een verhoogde kans op persoonlijke verwondingen.
- Laat reparaties alleen door een vakman uitvoeren**
Dit persluchtgereedschap voldoet aan de geldende veiligheidsvoorschriften. Reparaties mogen alleen worden uitgevoerd door een vakman. Anders kan de gebruiker te maken krijgen met ongevallen.

Bewaar deze veiligheidsvoorschriften goed.

3 609 929 498 • 99.10

**Tekniske data**

DK

**Trykluft indbygningmotor 180 W**

Bestillingsnummer 0 607 953 308	... 309	... 310	... 311	... 312	... 313
Omdrejningstal, ubelastet	[min ⁻¹] 820	1 250	1 700	3 000	5 400	660
Blokeringsmoment	[Nm] 8,0	5,3	3,7	2,1	1,1	7,5
Afgiven effekt	[W] 180	180	180	180	180	160
Omdrejningsretning	↻	↻	↻	↻	↻	↻
Værktøjsholder	3/8"-24 UNF-2A ●	●	●	●	●	●
Nominelt tryk	[bar/psi] 6,3/90	6,3/90	6,3/90	6,3/90	6,3/90	6,3/90
Slangtilslutning	G 1/8"	G 1/8"	G 1/8"	G 1/8"	G 1/8"	G 1/8"
Indvendig slangevidde	[mm] 6	6	6	6	6	6
Luftforbrug, belastet	[l/s] 6,0	6,0	6,0	6,0	6,0	7,2
Vægt (uden tilbehør) ca.	[kg] 0,58	0,58	0,58	0,50	0,50	0,64

Trykluft indbygningmotor 180 W

Bestillingsnummer 0 607 953 314	... 315	... 316	... 317	... 326
Omdrejningstal, ubelastet	[min ⁻¹] 1 050	1 400	2 600	4 600	2 000
Blokeringsmoment	[Nm] 5,1	3,5	2,0	1,0	3,1
Afgiven effekt	[W] 160	160	160	160	180
Omdrejningsretning	↻	↻	↻	↻	↻
Værktøjsholder	3/8"-24 UNF-2A ●	●	●	●	●
Nominelt tryk	[bar/psi] 6,3/90	6,3/90	6,3/90	6,3/90	6,3/90
Slangtilslutning	G 1/8"	G 1/8"	G 1/8"	G 1/8"	G 1/8"
Indvendig slangevidde	[mm] 6	6	6	6	6
Luftforbrug, belastet	[l/s] 7,2	7,2	7,2	7,2	6,0
Vægt (uden tilbehør) ca.	[kg] 0,64	0,64	0,56	0,56	0,58

3 609 929 498 • 99.10

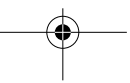
**Trykluft indbygningmotor 120 W**

Bestillingsnummer 0 607 954 304	... 305	... 306	... 307
Omdrejningstal, ubelastet	[min ⁻¹] 2 200	4 900	1 850	4 100
Blokeringsmoment	[Nm] 2,1	1,0	2,0	0,9
Afgiven effekt	[W] 120	120	100	100
Omdrejningsretning	↻	↻	↻	↻
Værktøjsholder	3/8"-24 UNF-2A ●	●	●	●
Nominelt tryk	[bar/psi] 6,3/90	6,3/90	6,3/90	6,3/90
Slangtilslutning	G 1/8"	G 1/8"	G 1/8"	G 1/8"
Indvendig slangevidde	[mm] 6	6	6	6
Luftforbrug, belastet	[l/s] 4,5	4,5	5,0	5,0
Vægt (uden tilbehør) ca.	[kg] 0,37	0,32	0,37	0,32

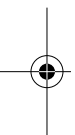



Maskinelementer

- 1 Værktøjsholder
- 2 Ispændingsområde
- 3 Slangetilslutning for højreløb
- 4 Slangetilslutning for venstreløb : Kun ved modeller med
- 5 Luftudgang med lydæmper*

*Tilbehør illustreret eller beskrevet tilbehør er kun delvis indeholdt i leverancen.

Tilbehør

Slangestuds 3 603 386 002
 Lyddæmper 3 607 000 016
 Fastgørelsesflange 180 W 3 605 700 044
 Fastgørelsesflange 120 W 3 605 700 043
 Special-gearfædt 225 ml 3 605 430 009

Luftforsyning

Den tilførte luft skal være fri for fremmedlegemer og fugtighed for at beskytte maskinen mod beskadigelse, snavs og rustdannelse.

Det er nødvendigt at benytte en trykluft-serviceenhed.

Samtlige armaturer, forbindelsesledninger og slanger skal kunne tåle trykket og den nødvendige luftmængde.

Undgå indsnævninger af luftledningerne f.eks. som følge af masning, knækning eller treakning!

Hvis De er i tvivl, kontrolleres trykket ved luftindgangen med et manometer, medens maskinen er i gang.

Serviceenhed

Serviceenheden sikrer en fejlfri funktion af trykluftmaskinerne.

Den består af tre hoveddele:

- Filter med vandudskiller,
- Trykreduktionsventil med manometer,
- Olieforstørningsanordning.

Smørstoffet i olieforstørningsanordningen:

Motorolie SAE 10/SAE 20.

Petroleum eller dieselolie må ikke anvendes.

Olieforstørningsanordningen skal indstilles således, at der dannes en tynd smørefilm ved luftudgangen.

Betjeningsvejledningen til serviceenheden skal overholdes.



For Deres egen sikkerheds skyld

Sikkert arbejde med maskinen er kun muligt, hvis De før brug læser brugsvejledningen og sikkerhedsforskrifterne helt igennem og overholder disse anvisninger.

Desuden skal afsnittet Sikkerhedsforskrifter for trykluftværktøj overholdes.

Sørg for at få en sagkyndig person til at vise Dem, hvordan maskinen fungerer, før den benyttes for første gang.

Afbryd luftforsyningen

Luftforsyningen skal afbrydes, når maskinen ikke er i brug, for vedligeholdelse og før indsatsværktøjet udsiftes.

- Hænderne må ikke være i nærheden af den roterende værktøjsholder og indsatsværktøjet. Hvis indsatsværktøjet brækker, kan brugeren blive kvæstet af væktilværende splitter.

- **Vær forsigtig ved snævre arbejdsforhold**
 Reaktionsmomenter gør, at brugeren kan blive kvæstet som følge af klemning.

Overbelast ikke maskinen.

Arbejd med det angivede nominelle tryk. Alle armaturer, forbindelsesledninger og slanger skal være konstrueret til at kunne klare det tryk og den nødvendige luftmængde, som maskinen har brug for.

Før ibrustagning

Fastgør kun indbygningmotoren i det angivede ispændingsområde **2** og benyt helst hele ispændingsområdet. Jo mindre ispændingsområdet er, desto effektivere er spændekræfterne.

- Overbelast ikke ispændingsområdet for indbygningmotoren.

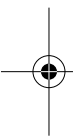
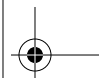



Montage

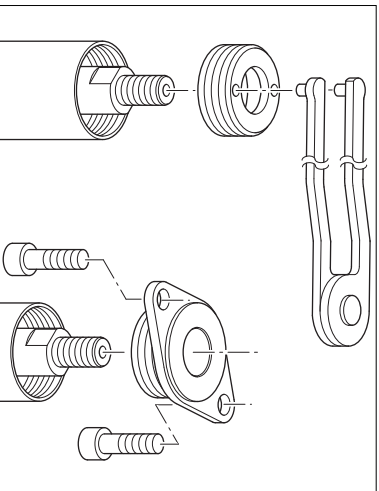

Skrú gevindrifngen ud med en hagenøgle (venstrege- vindi) og fastgørelsesflangen ind. Indbygningsmotoren skrues fast til ispændingsanordningen med de to skrúer på fastgørelsesflangen.

Ibrugtagning

Maskinen arbejder optimalt ved et overtryk på 6,3 bar (90 psi), målt ved løbende maskines lufttilgang.

Start-stop-kontakt

Hvis maskinen ikke starter f.eks. efter længere tids hvilepause, afbrydes lufttilførslen og værkøjsholderen **1** drejes rundt med hånden. Derefter afløses adhæsionskræfterne.



Sluk for maskinen, hvis luftforsyningen afbrydes eller driftstrykket reduceres. Kontrollér driftstrykket og start maskinen, når driftstrykket er optimalt.

Maskinen tændes og slukkes ved at tænde for og afbryde trykluftforsyningen.

Arbejdshenvisninger

Luftforsyningen skal afbrydes, før ethvert arbejde på maskinen påbegyndes.

Omdrejningsretning

Tilslut luftforsyningen til den venstre eller højre slange- studs afhængigt af den ønskede omdrejningsretning. Bøksringer, som opstår pludseligt, fører til et stærkt faldende omdrejningstal eller standsning. Dette beskadiger dog ikke motoren.

Type 0 607 953 308 / ... 309 / ... 310 /

... 311 / ... 312 / ... 326

Type 0 607 954 304 / ... 305

Højreløb:

Tiluftslange tilsluttes på slangetilslutning **3**.



Ved høje drejningsmomenter er der brug for en tilsvarende stor kontraholdkraft.

Denne kontraktkraft optages bedst med en ispændings- anordning i området **2**.

Sørg for at ekstrahåndtaget eller ispændingsanord- ningen holder maskinen sikkert og fast.

Type 0 607 953 313 / ... 314 / ... 315 /

... 316 / ... 317

Type 0 607 954 306 / ... 307

Højreløb:

Tiluftslange tilsluttes på slangetilslutning **3**.

Venstreløb:

Tiluftslange tilsluttes på slangetilslutning **4**.



Ved høje drejningsmomenter er der brug for en tilsvarende stor kontraholdkraft.

Denne kontraktkraft optages bedst med en ispændings- anordning i området **2**.

Sørg for at ekstrahåndtaget eller ispændingsanord- ningen holder maskinen sikkert og fast.

Drejningsmoment

Drejningsmomentet styres via driftstrykket.

Det angivne omdrejningstal i ubelæstet tilstand indstilles, når lydæmperen er tilsluttet. Hvis lydæmperen fjernes, skal omdrejningstallet kontrolleres. Et for højt omdrejningstal skal reduceres til det nominelle omdrejningstal med en drosselklapventil.

For højt omdrejningstal forårsager unødigt larm og reducerer motorens levetid.

Bortledning af gammel luft

Den gamle luft bortledes ved at fjerne lydæmperen **5** og tilslutte en slange til luftåbningen.

Fordele:

- mindre støj,
- arbejdspladsen bliver ikke snavset af ophvirvet støv,
- bortledning af gammel luft.



Vedligeholdelse og rengøring

Luftforsyningen skal afbrydes, før ethvert arbejde på maskinen påbegyndes.

Maskine og værktøjsholder skal altid holdes rene.

Skulle maskinen trods omhyggelig fabrikation og kontrol engang holde op at fungere, skal reparationen udføres af et autoriseret serviceværksted for BOSCH-
elektroværktøj.

Det 10-cifrede bestillingsnummer for maskinen skal altid angives ved forespørgsler og bestilling af reservedele.

Smøring

Smørestof:

Special-gearfedt

225 ml. 3 605 430 009

Motorolie SAE 10/SAE 20



Gearet renses første gang efter ca. 150 driftstimer, derefter hver 300. driftstime med rensebenzin og smøres derefter ind med special-gearfedt.

Dette arbejde udføres hurtigt og pålideligt af et Bosch-serviceværksted.

Smøre- og rengøringsstoffer skal bortskaffes på en miljøvenlig måde. Gældende lovbestemmelser skal overholdes.



Miljøbeskyttelse

Genbrug af råstoffer i stedet for bortskaffelse af affald

Maskine, tilbehør og emballage skal genbruges på en miljøvenlig måde.

Denne vejledning er skrevet på klorfrit genbrugspapir.



Industriværktøj-partner

VELTEC	
Telegrafvej 3	
2750 Ballerup	
☎ Service:	44 89 80 00
Kunderådgiver:	44 68 35 60
Fax:	44 89 80 03

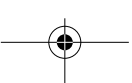
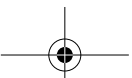

Garanti

Vi yder garanti på Bosch-maskiner i henhold til de lovbestemmelser som gælder i det enkelte land (købsbevis skal fremlægges/medsendes).

Service og reparation uden beregning ydes indenfor reklamationperioden iflg. dansk Købelov under følgende forudsætninger:

- at den opståede defekt kan tilbageføres til konstruktions- eller materialefejl (normal slitage og misbrug kan ikke henføres herunder)
- at reparation ikke har været forsøgt udført af andre end Bosch-organisations servicepersonale
- at der ikke har været anvendt uoriginale forsaets- eller indsatsværktøjer.

Serviceydelse uden beregning omfatter udskiftning af defekte dele samt arbejdsloen.

Værktøjet indleveres via Deres værktøjsforhandler eller indsendes for afsenders regning til Bosch Service værkstedet.

Betalbare reparationer udføres efter standardtider, som muliggør fast pris opgivet på forhånd.

Erklæring fra fabrikanten

Erklæring fra fabrikanten iht. 98/37/EF:

Dette produkt må udelukkende anvendes til montering i en anden maskine resp. til sammenbygning med en anden maskine eller andre maskiner. Idrifttagning er først tilladt, når det endelige produkt overholder bestemmelserne i direktivet 98/37/EF.

Dr. Gerhard Felten

Dr. Eckerhard Strötgen

Pro. Felten i.V. München

Robert Bosch GmbH, Geschäftsbereich Elektrowerkzeuge

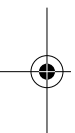



Sikkerhedsforskrifter for trykluftværktøj



Pas på! Ved brug af trykluftværktøj skal følgende principielle sikkerhedsforanstaltninger følges for at beskytte brugeren mod kvæstelser. Gennemlæs og følg disse forskrifter, før værktøjet tages i brug.

- Arbejdsområdet skal altid holdes i orden**
Jorden på arbejdsområdet medfører fare for uheld.
 - Tag hensyn til påvirkende elementer i arbejdsomgivelserne**
Sørg for god belysning. Arbejd ikke i eksplosionsstruede omgivelser.
 - Hold børn væk fra arbejdsområdet**
Hold andre personer væk fra Deres arbejdsområde.
 - Opbevar værktøj og indsatsværktøj på et sikkert sted**
Ubenyttet værktøj og indsatsværktøj skal opbevares i et tørt, lukket rum og skal holdes utilgængeligt for børn.
 - Kontroller luftforsyningen**
Kontroller luftforsyningen med regelmæssige mellemrum. Armaturer, forbindelsesledninger og slanger skal være konstrueret til at kunne tåle det tryk og den luftmængde, som værktøjet har brug for. Beskylt slangen mod kneæk, forsnævninger, varme og skarpe kanter. Beskadede slanger og koblinger skal repareres med det samme. Spænd slangebåndene rigtigt. En beskadiget trykluftslange kan medføre, at slangen slår om sig, som kan føre til kvæstelser. Opvirvlet støv eller spåner kan føre til alvorlige øjenskader.
 - Brug det rigtige værktøj**
Brug ikke for svage værktøjer eller indsatsværktøjer til tungt arbejde. Brug aldrig værktøj og indsatsværktøj til noget, det ikke er beregnet til.
 - Bær egnet arbejdsbeklædning**
Bær ikke vid beklædning eller smykker, som kan blive fanget af værktøjets bevægelige dele. Langt hår skal bæres under hænet. Bær skridsikket fodtøj, især ved uendørsarbejde.
 - Brug beskyttelsesbriller**
Brug ansigts- eller støvmaske hvis det drøjer sig om støvet arbejde.
 - Sikre det emne, som skal bearbejdes**
Benytt spændeanordninger som f.eks. en skruestik, til at holde emnet fast med. Det er mere sikkert end at holde det med hånden. Desuden kan værktøjet på denne måde holdes med begge hænder.
 - Sørg for at stå sikkert**
Undgå uheldige kropperpositioner. Sørg for at stå sikkert under arbejdet. Hold altid ligevægten.
 - Vedligehold værktøj og indsatsværktøj omhyggeligt**
Hold værktøjet rent og indsatsværktøj skarp, for at sikre godt og sikkert arbejde. Følg gældende vedligeholdelsesforskrifter og lovbelåede forskrifter for værktøjet. Håndgrib skal altid holdes tørre og frie for olie og fedt.
 - Afbryd luftforsyningen**
Luftforsyningen skal afbrydes, når maskinen ikke er i brug, før vedligeholdelse og før indsatsværktøjet udskiftes.
 - Lad aldrig værktøjsnøglen blive siddende i værktøjet**
Vær sikker på, at nøgler og indstillingsværktøj er fjernet, før værktøjet startes.
 - Undgå utilsigtede start**
Bær aldrig værktøj, som er tilsuttet luftforsyningen, med fingeren på afbryderen. Vær sikker på, at værktøjet er slukket, når det tilsuttes luftforsyningen.
 - Vær altid opmærksom**
Hold øje med arbejdet. Bevæg værktøjet med fornuft og ro. Benyt ikke værktøjet ved manglende koncentration.
 - Kontroller værktøjet for beskadigelser**
Kontroller beskyttelsesanordninger eller let beskadigede dele omhyggeligt for korrekt og bestemmelsesmæssig funktionsevne, før værktøjet benyttes igen. Kontroller om bevægelige dele er i orden, om de ikke sidder i klamme eller om dele er beskadiget. Alle dele skal være monteret rigtigt og alle betingelser skal være opfyldt for at sikre, at værktøjet fungerer rigtigt.
Beskadede beskyttelsesanordninger og dele skal repareres eller udskiftes fagligt korrekt af et autoriseret serviceværksted, medmindre andet er anført i brugsanvisningerne. Beskadede kontakter skal erstattes på et serviceværksted. Benyt ikke værktøjer, hvis afbryder ikke fungerer.
 - Pas på!**
Benytt for Deres egen sikkerheds skyld kun tilbehør og værktøjer, som angives i brugsanvisningen. Brug af indsatsværktøj eller tilbehør, som ikke er anbefalet i brugsanvisningen eller i kataloget, kan føre til kvæstelser.
 - Reparationer kun af fagmanden**
Dette trykværktøj overholder gældende sikkerhedsbestemmelser. Reparationer må kun udføres af en fagmand, da der ellers kan opstå uheld for brugeren.
- Opbevar sikkerhedsforskrifterne på et sikkert sted.**

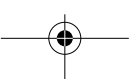
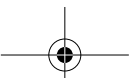



Specifikationer

S

Tryckluftmotor för inbyggnad 180 W

Artikelnummer 0 607 953 308	... 309	... 310	... 311	... 312	... 313
Tomgångsvarvtal	[min ⁻¹] 820	1 250	1 700	3 000	5 400	660
Strömmoment	[Nm] 8,0	5,3	3,7	2,1	1,1	7,5
Avgiven effekt	[W] 180	180	180	180	180	160
Rotationsriktning	↺	↺	↺	↺	↺	↺
Verktygshållare	3/8"-24 UNF-2A ●	●	●	●	●	●
Nominellt tryck	[bar/psi] 6,3/90	6,3/90	6,3/90	6,3/90	6,3/90	6,3/90
Slanganslutning	G 1/8"	G 1/8"	G 1/8"	G 1/8"	G 1/8"	G 1/8"
Inre slangdiameter	[mm] 6	6	6	6	6	6
Luftförbrukning under last	[l/s] 6,0	6,0	6,0	6,0	6,0	7,2
Vikt (utan tillbehör) ca.	[kg] 0,58	0,58	0,58	0,50	0,50	0,64

Tryckluftmotor för inbyggnad 180 W

Artikelnummer 0 607 953 314	... 315	... 316	... 317	... 326
Tomgångsvarvtal	[min ⁻¹] 1 050	1 400	2 600	4 600	2 000
Strömmoment	[Nm] 5,1	3,5	2,0	1,0	3,1
Avgiven effekt	[W] 160	160	160	160	180
Rotationsriktning	↺	↺	↺	↺	↺
Verktygshållare	3/8"-24 UNF-2A ●	●	●	●	●
Nominellt tryck	[bar/psi] 6,3/90	6,3/90	6,3/90	6,3/90	6,3/90
Slanganslutning	G 1/8"	G 1/8"	G 1/8"	G 1/8"	G 1/8"
Inre slangdiameter	[mm] 6	6	6	6	6
Luftförbrukning under last	[l/s] 7,2	7,2	7,2	7,2	6,0
Vikt (utan tillbehör) ca.	[kg] 0,64	0,64	0,56	0,56	0,58



3 609 929 498 • 99.10

Tryckluftmotor för inbyggnad 120 W

Artikelnummer 0 607 954 304	... 305	... 306	... 307
Tomgångsvarvtal	[min ⁻¹] 2 200	4 900	1 850	4 100
Strömmoment	[Nm] 2,1	1,0	2,0	0,9
Avgiven effekt	[W] 120	120	100	100
Rotationsriktning	↺	↺	↺	↺
Verktygshållare	3/8"-24 UNF-2A ●	●	●	●
Nominellt tryck	[bar/psi] 6,3/90	6,3/90	6,3/90	6,3/90
Slanganslutning	G 1/8"	G 1/8"	G 1/8"	G 1/8"
Inre slangdiameter	[mm] 6	6	6	6
Luftförbrukning under last	[l/s] 4,5	4,5	5,0	5,0
Vikt (utan tillbehör) ca.	[kg] 0,37	0,32	0,37	0,32



Maskinenkomponenter

- 1 Verktygsbälare
- 2 Inspänningsparti
- 3 Slangkoppling för högergång 
- 4 Slangkoppling för vänstergång  endast på maskiner med 
- 5 Luftutlopp med ljuddämpare*

*Tillbehör
 Avbildat eller beskrivet tillbehör ingår delvis inte i leveransomfånget.

Tillbehör

Slangstuds 3 603 386 002
 Ljuddämpare 3 607 000 016
 Fästfläns 180 W 3 605 700 044
 Fästfläns 120 W 3 605 700 043
 Special växelhussett 225 ml 3 605 430 009



Säkerhetsåtgärder



För att riskritt kunna använda maskinen bör du noggrant läsa igenom bruksanvisningen och exakt följa de instruktioner som lämnas i säkerhetsanvisningarna. I tillägg måste avsnittet **Säkerhetsanvisningar för tryckluftverktyg** beaktas.
 Låt en fackman instruera dig i maskinens användning.

- **Avstängning av lufttillförsel**
 Luftförsörjningen ska stängas av under arbetspauser samt innan underhållsåtgärder utförs och insatsverktyg byts ut.
- Håll händerna på betryggande avstånd från verktygsflälaren och insatsverktyget. Om insatsverktyget går sönder kan utslungade spjletter medföra kroppsskada.
- **Var försiktig vid tränga arbetförhållanden**
 Till följd av reaktionsmoment kan klämskador uppstå.
- **Överbelasta ej maskinen.**
 Arbeta med nominellt tryck.
 Samtliga amaturer, förbindelseledningar och slangar måste dimensioneras att motsvara aktuellt tryck och erforderlig luftmängd.

- Vid inspänning av inbyggnadsmotorn i en fixtur använd fästflänsen och beakta säkerhetsanvisningarna för fixturen.

- Överbelasta inte inbyggnadsmotorns inspänningsparti.
- Bosch kan endast garantera att maskinen fungerar felfritt om originaltillbehör används.

Lufttillförsel

Den tillförda luften får inte innehålla främmande partiklar eller fukt. Nedsnitsad eller fuktig luft kan leda till att maskinen skadas, förorenas eller börjar rosta.

En luftbehandlingsenhet skall användas.

Alla amaturer, anslutningsledningar och slangar måste vara anpassade till aktuellt tryck och använd luftvolym.

Undvik hopsnörning av tilloppsledningarna som kan uppstå t ex genom klämning, kräckning eller utdragning!

I tvexsamna fall kontrollera med manometer trycket vid luftinloppet på tillslagen maskin.

Luftbehandlingsenhet

Luftbehandlingsenheten garanterar att tryckluftverktygen fungerar felfritt.

- Består av tre huvudkomponenter:
- Filter med vattenavskiljare,
 - Tryckreducerventil med manometer,
 - Dimsnörapparat.

Smörjmedel i smörjapparaten:
 motorolja SAE 10/SAE 20.

Använd inte petroleum eller dieselolja.

Ställ in dimsnörjapparaten så att en tunn smörjfilm uppstår vid luftutloppet.

Följ bruksanvisningen för luftbehandlingsenheten.

Kontroll före start

Fäst inbyggnadsmotorn endast vid angivet inspänningsparti **2** och uthytta om möjligt hela inspänningspartiet. Ju mindre inspänningspartiet är, desto större blir spännkrafterna.

- Överbelasta inte inbyggnadsmotorns inspänningsparti.

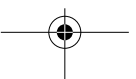
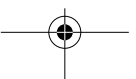



Montering

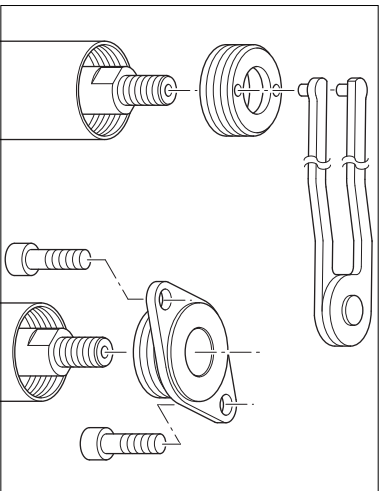

Skruva bort gängringen (vänstergående) med en haknyckel och skruva fast fästflänsen. Inbyggingsmotorn kan med fästflänsen och två skruvar monteras på fixturen.

Start

Maskinen drivs optimalt med ett övertryck på 6,3 bar (90 psi) uppmätt på tillslagen maskin vid luftutloppet.

In- och urkoppling

Om maskinen inte startar t ex efter en längre paus, frånkoppla lufttillförseln och dra runt verktygsfästet **1** för hand. På detta sätt kan adhesionskrafter elimineras.



Vid avbrott i luftförsörjningen eller reducerat drifttryck ska maskinen frånkopplas. Kontrollera drifttrycket och starta sedan på nytt med optimalt drifttryck.

In- och urkopplingen av maskinen sker genom tillslag resp fränslag av tryckluftsförsörjningen.

Arbetsanvisningar

Frånkoppla alltid lufttillförseln innan åtgärder vidtas på maskinen.

Rotationsriktning

Alltefter önskad rotationsriktning ansluts luftförsörjningen till vänster eller höger slangstuts.

Påslåligt uppstående belastningar medför kraftig varvtalsminskning eller stillestånd, men skadar inte motorn.

Typ 0 607 953 308 / ... 309 / ... 310 /

... 311 / ... 312 / ... 326

Typ 0 607 954 304 / ... 305

⌚ Högergång:

Anslut tilluftsslangen till koppling **3**.



Vid höga vridmoment krävs en motsvarande mothållskraft.

Med en fixtur kring partiet **2** kan mothållskraften tas upp effektivare.

Se till att stödhandlaget eller fixturen håller maskinen säkert och stadigt i läge.

Typ 0 607 953 313 / ... 314 / ... 315 /

... 316 / ... 317

Typ 0 607 954 306 / ... 307

⌚ Högergång:

Anslut tilluftsslangen till koppling **3**.

⌚ Vänstergång:

Anslut tilluftsslangen till koppling **4**.



Vid höga vridmoment krävs en motsvarande mothållskraft.

Med en fixtur kring partiet **2** kan mothållskraften tas upp effektivare.

Se till att stödhandlaget eller fixturen håller maskinen säkert och stadigt i läge.

Vridmoment

Vridmomentet kan regleras via drifttrycket.

Vid ansluten ljuddämpare ställs angivet tomgångsvarvtal automatiskt in. Avlägsnas ljuddämparen ska varvtalet kontrolleras. För höga varv ska med strypdon reduceras till nominellt varvtal.

För höga varvtal medför onödigt buller och nedsätter apparatens livslängd.

Frånluftens bortföring

Ta bort ljuddämparen **5** och anslut sedan en slang till luftutloppet för bortföring av returluft.

Fördelar:

- reducerad ljudnivå,
- ingen nedsmutsning av arbetsplatsen till följd av uppvisvat damm,
- frånluftstyrning.





Skötsel och rengöring

Frånkoppla alltid lufttillförseln innan åtgärder vidtas på maskinen.

Håll alltid maskinen och verktygsfästet rena.

Om i apparaten trots exakt tillverkning och sträng kontroll störmning skulle uppstå, bör reparation utföras av auktoriserad serviceverkstad för BOSCH elverktyg.

Var vänlig ange vid förfrågningar och reservdelbeställningar apparatens artikelnummer som består av 10 siffror.

Smörjning

Smörjmedel:

Special växelhusfett

225 ml. 3 605 430 009

Motorolja SAE 10/SAE 20



Tvätta växelhuset med tvättbensin första gången efter ca 150 drifttimmar och därefter i intervaller om 300 drifttimmar samt smörj med special växelhusfett.

Bosch serviceverkstaden utför dessa arbeten snabbt och tillförlitligt.

Omhändertata smörj- och rengöringsmedel på miljövänligt sätt. Följ tillämpliga lagbestämmelser.



Leverantörsansvar

För Bosch verktygsprodukter jämnas garanti enligt respektive lands gällande föreskrifter (nästa styckas med kvitto, faktura eller följesedel).

Har produkten köpts och brukats enligt konsumentköplagens bestämmelser så gäller lagens bestämmelser.

Leverantörsansvaret gäller fabriktions- och materialfel. Skador som orsakats av överbelastning eller osakkunnigt handhavande och normalt slitage omfattas ej av leverantörsansvaret.

Vid reklamation ska produkten inlämnas till närmaste auktoriserade serviceverkstad i **odemonterat** skick.

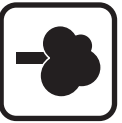

Miljöhänsyn

Återvinning i stället för avfallsantering

Maskin, tillbehör och förpackning kan återvinnas.

Denna bruksanvisning är tryckt på klorfritt returpapper.



Industriverktygspartner

Elektro Lindning AB
Hollanargatan 18

Box 45066

104 30 Stockholm

☎ 86 73 56 55

Fax 821 09 21

Bosch Snabbservice

Malmagatan 14

602 23 Norrköping

☎ 011-19 65 58

Fax 011-10 48 90

Tilverkarrens försäkran

Tilverkarrens försäkran enligt 98/37/EG:

Denna produkt är avsedd uteslutande för montering i annan maskin eller för kombination med annan maskin eller andra maskiner. Driftstart är tillåten först sedan slutproduktens överensstämmelse med bestämmelserna i riktlinjen 98/37/EG är garanterad.

Dr. Gerhard Felten

Dr. Eckerhard Strögen

ppa. Felten i.V. Mörten

Robert Bosch GmbH, Geschäftsbereich Elektrowerkzeuge



Säkerhetsanvisningar för tryckluftverktyg

Obs! För att undvika olyckshändelser vid användning av luftdrivna verktyg bör följande allmänna säkerhetsåtgärder beaktas.
Läs noga igenom instruktionerna innan maskinen tas i drift och följ anvisningarna under arbetet.

- Håll alltid arbetsplatsen i ordentligt skick**
Ordning på arbetsplatsen medför risk för olyckor.
- Ta hänsyn till miljöpåverkan**
Ordna med bra belysning. Arbeta inte i omgivning med explosionsrisk.
- Håll barn på betryggande avstånd från arbetsområdet**
Håll obehöriga på avstånd från arbetsområdet.
- Förvara maskinen och verktygen på säkert sätt**
Förvara maskinen och verktygen i ett torrt, stängt och för barn oåtkomligt utrymme.
- Kontrollera luftförsörjningen**
Kontrollera regelbundet luftförsörjningen. Alla armaturer, anslutningsledning och slangar måste vara anpassade till aktuellt tryck och erforderlig luftvolym. Skydda slangarna mot kräckning, hopsnörning, värme och vassa kanter. Skadade slangar och kopplingar ska omedelbart åtgärdas; dra kräftigt fast slangklämmorna. Defekta luftförsörjning kan leda till att tryckluftsslangen sprätter runt och förorsakar skador. Upprivnat damm och spånor kan medföra allvarliga ögonskador.
- Använd lämpliga maskiner och verktyg**
Använd inte för svaga maskiner eller verktyg för tunga arbeten. Använd maskinerna endast för de ändamål och arbeten de är avsedda för.
- Använd lämpliga arbetskläder**
Använd varken löstlittande kläder eller smycken som kan dras in av maskinens rörliga delar. Har du långt hår, använd hämnät. Speciellt under arbete utomhus ska hälkra skor användas.
- Använd skyddsglasögon**
Använd även andningsskydd om damm uppstår under arbetet.
- Säkra arbetsstycket**
Använd uppspänningsutrustning som t ex skruvståd för stadig fastspänning av arbetsstycket. Arbetsstycket ligger då stadigt och maskinen kan manövreras med båda händerna.
- Se till att du står stadigt**
Stå stadigt, håll balansen och undvik onormalt kroppsläge.

- Sköt väl om maskinen och insatsverktygen**
Genom att hålla maskinen och insatsverktygen rena garanteras optimalt arbetsresultat. Följ underhållsinstruktionerna och anvisningarna för verktygsbyte. Håll alltid handtagen torra och fria från olja och fett.

- Avstängning av lufttillförsel**
Luftförsörjningen ska stängas av under arbetspauser samt innan underhållsåtgärder utförs och insatsverktyg byts ut.
- Gå inte kvar verktygsnycklar på maskinen**
Kontrollera innan maskinen slås på att alla nycklar och inställningsverktyg tagits bort.
- Undvik oavsiktlig maskinstart**
En till luftförsörjningen ansluten maskin får aldrig bäras så att fingrar vilar på omkopplaren. Kontrollera att maskinen är avstängd när den ansluts till luftförsörjningen.
- Var alert under arbetet**
Var uppmärksam under arbetet. Arbeta lugnt och sansat. Använd inte maskinen om du är okoncentrerad.
- Kontroll av maskin**
Innan maskinen tas i bruk bör du kontrollera att skyddsutrustningen och eventuellt lätt skadade delar fungerar felfritt och ändamålsenligt. Kontrollera även funktionen på maskinens rörliga delar, dvs att de inte kärvar och att de är oskadade. Maskinens alla delar ska vara korrekt monterade och uppfylla de krav som garanterar felfri drift.
Skadad skyddsutrustning och defekta delar ska repareras eller bytas ut på auktoriserad serviceverkstad om inte annat angivits i bruksanvisningen. Skadad omkopplare ska bytas ut på auktoriserad serviceverkstad. Använd inte maskinen om omkopplaren inte fungerar felfritt.
- Obs!**
För din personliga säkerhet bör du använda endast de tillbehör och påbyggnadsdelar som ommärnts i bruksanvisningen. Används andra insatsverktyg eller tillbehör än de som rekommenderas i bruksanvisningen finns risk för kroppsskador.
- Reparationer får utföras endast av fackman**
Detta luftdrivna verktyg uppfyller gällande säkerhetskrav. Reparationer får utföras endast av fackman, i annat fall finns risk för olycksfall.

Förvara säkerhetsanvisningarna lättillgängliga.

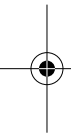

**Tekniske data****Trykkluft-inbyggingsmotor 180 W**

Bestillingsnummer 0 607 953 308	... 309	... 310	... 311	... 312	... 313
Tomgangsturtall	[min ⁻¹] 820	1 250	1 700	3 000	5 400	660
Kvelenoment	[Nm] 8,0	5,3	3,7	2,1	1,1	7,5
Avgitt effekt	[W] 180	180	180	180	180	160
Dreieretning						
Vertikøyste	3/8"-24 UNF-2A ●	●	●	●	●	●
Nomnett trykk	[bar/psi] 6,3/90	6,3/90	6,3/90	6,3/90	6,3/90	6,3/90
Slangekopling	G 1/8"	G 1/8"	G 1/8"	G 1/8"	G 1/8"	G 1/8"
Slangebreidde	[mm] 6	6	6	6	6	6
Luftforbruk under belastning	[l/s] 6,0	6,0	6,0	6,0	6,0	7,2
Vekt (uten tilbehør) ca.	[kg] 0,58	0,58	0,58	0,58	0,50	0,64

Trykkluft-inbyggingsmotor 180 W

Bestillingsnummer 0 607 953 314	... 315	... 316	... 317	... 326
Tomgangsturtall	[min ⁻¹] 1 050	1 400	2 600	4 600	2 000
Kvelenoment	[Nm] 5,1	3,5	2,0	1,0	3,1
Avgitt effekt	[W] 160	160	160	160	180
Dreieretning					
Vertikøyste	3/8"-24 UNF-2A ●	●	●	●	●
Nomnett trykk	[bar/psi] 6,3/90	6,3/90	6,3/90	6,3/90	6,3/90
Slangekopling	G 1/8"	G 1/8"	G 1/8"	G 1/8"	G 1/8"
Slangebreidde	[mm] 6	6	6	6	6
Luftforbruk under belastning	[l/s] 7,2	7,2	7,2	7,2	6,0
Vekt (uten tilbehør) ca.	[kg] 0,64	0,64	0,56	0,56	0,58

3 609 929 498 • 99.10

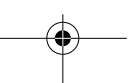
**Trykkluft-inbyggingsmotor 120 W**

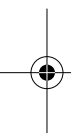

Bestillingsnummer 0 607 954 304	... 305	... 306	... 307
Tomgangsturtall	[min ⁻¹] 2 200	4 900	1 850	4 100
Kvelenoment	[Nm] 2,1	1,0	2,0	0,9
Avgitt effekt	[W] 120	120	100	100
Dreieretning				
Vertikøyste	3/8"-24 UNF-2A ●	●	●	●
Nomnett trykk	[bar/psi] 6,3/90	6,3/90	6,3/90	6,3/90
Slangekopling	G 1/8"	G 1/8"	G 1/8"	G 1/8"
Slangebreidde	[mm] 6	6	6	6
Luftforbruk under belastning	[l/s] 4,5	4,5	5,0	5,0
Vekt (uten tilbehør) ca.	[kg] 0,37	0,32	0,37	0,32

50





Apparatelementer

- 1 Verktøyfeste
- 2 Innspenningsområde
- 3 Slangekopling for høyregang 
- 4 Slangekopling for venstregang  kun på maskiner med 
- 5 Luftutgang med lydtemper*

*Tilbehør illustrert eller beskrevet tilbehør inngår delvis ikke i leveransen.

Tilbehør

Slangestuss	3 603 386 002
Lydtemper	3 607 000 016
Festeflens 180 W	3 605 700 044
Festeflens 120 W	3 605 700 043
Spesial-griffett	
225 ml	3 605 430 009



For din sikkerhet



Farefritt arbeid med maskinen er kun mulig hvis du leser hele bruksanvisningen og alle sikkerhetshenvisningene og følger de oppgitte anvisningene nøye. I tillegg må avsnittet **Sikkerhets-henvisninger for trykkluftapparater** følges.

Sørg for å få demonstrert maskinen før førstegangs bruk.

- **Steng lufttilførselen**
Steng lufttilførselen når apparatet ikke er i bruk og før det utføres vedlikehold samt før innsatsverktøy skiftes ut.
- Hold hendene unna det roterende verktøyfestet og innsatt verktøy. Når innsatsverktøy brykker kan splinter som slynges bort forårsake skader.
- **Vær påpasselig på trange arbeidsplasser**
Reaksjonsmomentene kan føre til skader på grunn av fastfjerning.
- **Ikke overbelast maskinen.**
Arbeid med angitt nominelt trykk.
Samtlige armaturer, forbindelsesledninger og slanger må være egnet for trykket og den nødvendige luftmengden.

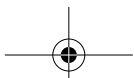

3 609 929 498 • 99.10

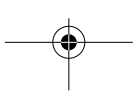

Lufttilførsel

Den tilførte luften må være fri for fremmedlegemer og fuktighet, for å beskytte maskinen mot skader, smuss og rustdannelse.

Det er nødvendig å bruke en trykkluft-serviceenhet.

Samtlige armaturer, forbindelsesledninger og slanger må være tilpasset trykket og den tilsvarende luftmengden.

Ungå innsnevring i tilførselledningen ved f.eks. klemming, knekking eller sterk strekking! I tvilstilfeller må trykket på luftinntaket kontrolleres med et manometer mens maskinen er i gang.

Serviceenhet

Serviceenheten sikrer at trykkluftverktøyet fungerer feilfritt.

Enheten består av tre hovedkomponenter:

- Filter med vannstikler,
- Trykkreduksjonsventil med manometer,
- Ojletåkesmører.

Smøremiddel i ojetåkesmører:

Motorolie SAE 10/SAE 20.

Ikke bruk petroleum eller dieselloje.

Instill ojetåkesmørerer slik at det dannes et tynt smøresjikt på luftutgangen.

Følg bruksanvisningen for serviceenheten.

Før igangsettingen

Fest innbyggingsmotoren kun i angitt innspenningsområde **2** og bruk høist hele innspenningsområdet. Jo mindre innspenningsområde, desto sterkere virker spennkrefte.

- Ikke overbelast innspenningsområdet til innbyggingsmotoren.

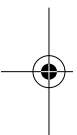



Montering

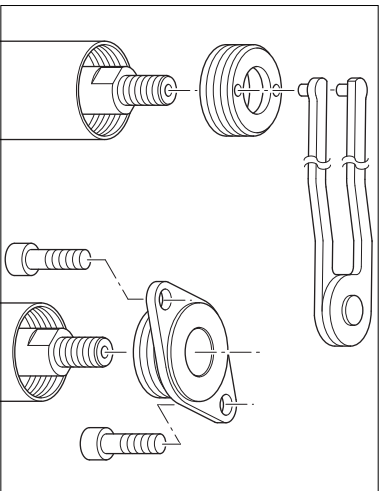

Skrú gjengeringen ut med en hakenøkkel (venstrejengell) og skrú inn festelønsen. Innbyggingsmotoren kan skrúes på innspenningsanordningen på festelønsen med to skrúer.

Igangsettingen

Maskinen arbeider best ved et overtrykk på 6,3 bar (90 psi), målt ved luftinntaket mens maskinen er i gang.

lInn-/utkopling

Hvis maskinen ikke starter, f.eks. etter å ikke ha vært i bruk i lengre tid, må lufttilførselen avbrytes og værktøyholder **1** dreies helt rundt pr. hånd. Slik fjernes adhesjonskrefter.



Ved avbrudd i lufttilførselen eller redusert driftstrykk må maskinen slås av. Kontroller driftstrykket og start igjen ved optimalt driftstrykk.

Inn- og utkobling av maskinen utføres ved å slå på hhv. stenge trykklufttilførselen.

Arbeidshenvisninger

Før alle arbeider på maskinen må lufttilførselen avbrytes.

Dreieretning

Alt etter ønsket dreieretning kobles lufttilførselen til venstre eller høyre slangesøtts.

Plutselige belastninger medfører en sterk turtallreduksjon eller stillstand, men skader ikke motoren.

Type 0 607 953 308 / ... 309 / ... 310 /

... 311 / ... 312 / ... 326

Type 0 607 954 304 / ... 305

⌚ Høyregang:

Tilførselsluftslangen koples til slangekopling **3**.



Ved høye dreiemomenter er det nødvendig med tilsvarende store krefter for å holde imot.

Med en innspenningsdel i område **2** er det enklere å holde imot.

Sørg for at ekstrahåndtaket hhv. innspenningsdelen holder maskinen godt fast.

Type 0 607 953 313 / ... 314 / ... 315 /

... 316 / ... 317

Type 0 607 954 306 / ... 307

⌚ Høyregang:

Tilførselsluftslangen koples til slangekopling **3**.

⌚ Venstre gang:

Tilførselsluftslangen koples til slangekopling **4**.



Ved høye dreiemomenter er det nødvendig med tilsvarende store krefter for å holde imot.

Med en innspenningsdel i område **2** er det enklere å holde imot.

Sørg for at ekstrahåndtaket hhv. innspenningsdelen holder maskinen godt fast.

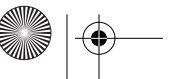
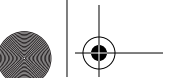
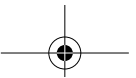
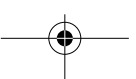



Service og rengjøring

Før alle arbeider på maskinen må lufttilførselen avbrytes.

Hold alltid maskinen og verktøyholderen rene.

Skulle apparatet svikte engang på tross av omhyggelige produktjons- og kontrollmetoder, må reparasjonen utføres av en autorisert kunde-service for Bosch-elektroverktøy.

Ved alle forespørsler og reservedelbestillinger må du absolutt oppgi maskinens 10-sifrede bestillingsnummer!



Smøring

Smøremiddel:
 Spesial-girfett
 225 ml. 3 605 430 009
 Motorolje SAE 10/SAE 20

Vask giret med rensebensin for første gang etter ca. 150 driftstimer, deretter hver. 300 driftstimer og smør med spesial-girfett.

Et Bosch-serviceverksted utfører disse arbeidene hurtig og pålitelig.

Smøre- og rengjøringsmidler må deponeres miljøvennlig. Følg lover og forskrifter.

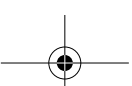

3 609 929 498 • 99.10

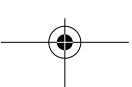

Produsenteklæring

Produsenteklæring i hht. 98/37/EF:

Dette produktet er utelukkende bestemt til å settes inn i en annen maskin eller til å settes sammen med en annen maskin eller andre maskiner. Det er forbudt å ta maskinen i bruk før det er festsått at sluttproduktet oppfyller kravene i direktiv 98/37/EF.

Dr. Gerhard Felten

Dr. Eckehard Strötgen

Robert Bosch GmbH, Geschäftsbereich Elektrowerkzeuge

ppa. Felten i: R. Strötgen

Miljøvern

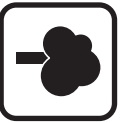

Råstoffgjenvinning i stedet for avfallsdeponering

Maskin, tilbehør og forpakning bør resirkuleres.

Denne bruksanvisningen er laget av klorfritt resirkulert papir.

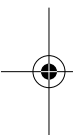



Sikkerhetsinformasjoner for trykkluftapparater



OBS! Ved bruk av trykkluftapparater må følgende prinsipielle sikkerhetsiltak følges for å unngå skader. Les og følg disse reglene før du bruker apparatet.

- 1. Hold arbeidsområdet ryddig.**
Fot i arbeidsområdet medfører fare for uhell.
 - 2. Ta hensyn til miljøinnflytelser**
Sørg for bra belysning. Arbeid ikke i eksplosjonstrange omgivelser.
 - 3. Hold barn unna arbeidsområdet**
Hold andre personer unna arbeidsområdet.
 - 4. Oppbevar apparater og verktøy på et sikkert sted**
Apparater og innsatsverktøy som ikke brukes må oppbevares i et tørt, lukket rom og utlignegelig for barn.
 - 5. Kontroller lufttilførselen**
Kontroller lufttilførselen med jevne mellomrom. Samtlige armaturer, forbindelsesledninger og slanger må være tilpasset trykket og den nødvendige luftmengden. Beskytt slangen mot brett, innsnevring, skarpe kanter og varme. La skadede slanger og koblinger straks repareres, og trekk slangeklammerne godt til. En defekt lufttilførsel kan forårsake at trykkluftslangen slynges rundt og fører til skader. Oppvinklet støv eller spon kan forårsake alvorlige øyeshkader.
 - 6. Bruk riktig verktøy**
Ikke bruk for svake apparater eller forsatsverktøy til tungt arbeid. Ikke bruk apparatene til formål og typer arbeid de ikke er beregnet til.
 - 7. Bruk egnede arbeidsklær**
Ikke bruk vide klær eller smykker. De kan komme inn i bevegelige deler. Bruk hårnett hvis du har langt hår. Ved utendørs arbeid anbefales det å bruke sklisikre sko.
 - 8. Bruk vernebrille**
Bruk støvmaske ved støvdannende arbeid.
 - 9. Arbeidsemetet må sikres**
Bruk spenninnetninger eller en skruslikke for å holde fast arbeidsemetet. Det holdes da sikrere enn med hånden din og gir deg muligheten til å befatte maskinen med begge hender.
 - 10. Sørg for å stå stødig**
Unngå unormale kroppsstillinger. Sørg for å stå stødig og hold alltid likevekten.
 - 11. Still apparatene og verktøyene omhyggelig**
Hold apparatet rent og verktøyene skarpe for å kunne arbeide bra og sikkert. Følg vedlikeholdsforskriftene og henvisningene om verktøyskifte. Hold håndtakene tørre og frie for olje og fett.
 - 12. Steng lufttilførselen**
Steng lufttilførselen når apparatet ikke er i bruk og før det utføres vedlikehold samt for innsatsverktøy skiftes ut.
 - 13. Ikke la verktøynøkler bli stående i**
Kontroller at nøklene og innstillingsverktøyene er fjernet før apparatet slås på.
 - 14. Unngå utilsikket starting**
Bær aldri apparater som er tilkoblet lufttilførselen med fingeren på bryteren. Forviss deg om at apparatet er slått av når det kobles til lufttilførselen.
 - 15. Vær alltid påpasselig**
Hold øye med arbeidet ditt. Arbeid på en fornuftig måte. Ikke bruk apparatet når du er ukonsentert.
 - 16. Kontroller om apparatet er skadet**
Kontroller beskyttelsesinnetningene eller deler som lett kan skades før bruk med hensyn til feilfri og formålsmessig funksjon. Kontroller om de bevegelige delene fungerer riktig, at de ikke klemmer eller om deler er skadet. Samtlige deler må være riktig montert og oppfylle alle betingelser for å sikre en feilfri drift av apparatet. Skadede beskyttelsesinnetninger og deler må repareres eller skiftes sakskyndig ut av et kundeservice-verksted hvis innet annet er angitt i driftsinstruksen. Skadede brytere må skiftes ut av et kundeservice-verksted. Ikke bruk apparater der bryteren ikke kan slås av og på.
 - 17. OBS!**
For din egen sikkerhets skyld må du kun bruke tilbehør og ekstrapparat som er angitt i bruksanvisningen. Bruk av andre innsatsverktøy eller annet tilbehør enn de som er angitt i bruksanvisningen eller i katalogen kan medføre en personlig fare for skader.
 - 18. Reparasjoner kun av fagfolk**
Dette trykkluftapparatet oppfyller de vanlige sikkerhetsbestemmelsene. Reparasjoner må kun utføres av fagfolk, ellers kan det medføre uhell for brukeren.
- Ta godt vare på disse sikkerhetsinformasjonene.**

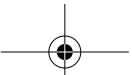

**Tekniset tiedot**

FIN

Sisäänrakennettava painelilmamoottori 180 W

Tilausnumero 0 607 953 308	... 309	... 310	... 311	... 312	... 313
Tyhjäkäyntikerrosluku	[min ⁻¹] 820	1 250	1 700	3 000	5 400	660
Kuristusmomentti	[Nm] 8,0	5,3	3,7	2,1	1,1	7,5
Antoteho	[W] 180	180	180	180	180	160
Kiertosuunta	↺	↺	↺	↺	↺	↺
Työkälunpidin	3/8"-24 UNF-2A ●	●	●	●	●	●
Nimellispaine	[bar/psi] 6,3/90	6,3/90	6,3/90	6,3/90	6,3/90	6,3/90
Leikun liitoskoti	G 1/8"	G 1/8"	G 1/8"	G 1/8"	G 1/8"	G 1/8"
Leikun sisämita	[mm] 6	6	6	6	6	6
Iimantarve kuormiituna	[l/s] 6,0	6,0	6,0	6,0	6,0	7,2
Paino (ilman tarvikkaita) n.	[kg] 0,58	0,58	0,58	0,50	0,50	0,64

Sisäänrakennettava painelilmamoottori 180 W

Tilausnumero 0 607 953 314	... 315	... 316	... 317	... 326
Tyhjäkäyntikerrosluku	[min ⁻¹] 1 050	1 400	2 600	4 600	2 000
Kuristusmomentti	[Nm] 5,1	3,5	2,0	1,0	3,1
Antoteho	[W] 160	160	160	160	180
Kiertosuunta	↺	↺	↺	↺	↺
Työkälunpidin	3/8"-24 UNF-2A ●	●	●	●	●
Nimellispaine	[bar/psi] 6,3/90	6,3/90	6,3/90	6,3/90	6,3/90
Leikun liitoskoti	G 1/8"	G 1/8"	G 1/8"	G 1/8"	G 1/8"
Leikun sisämita	[mm] 6	6	6	6	6
Iimantarve kuormiituna	[l/s] 7,2	7,2	7,2	7,2	6,0
Paino (ilman tarvikkaita) n.	[kg] 0,64	0,64	0,56	0,56	0,58



3 609 929 498 • 99.10

Sisäänrakennettava painelilmamoottori 120 W

Tilausnumero 0 607 954 304	... 305	... 306	... 307
Tyhjäkäyntikerrosluku	[min ⁻¹] 2 200	4 900	1 850	4 100
Kuristusmomentti	[Nm] 2,1	1,0	2,0	0,9
Antoteho	[W] 120	120	100	100
Kiertosuunta	↺	↺	↺	↺
Työkälunpidin	3/8"-24 UNF-2A ●	●	●	●
Nimellispaine	[bar/psi] 6,3/90	6,3/90	6,3/90	6,3/90
Leikun liitoskoti	G 1/8"	G 1/8"	G 1/8"	G 1/8"
Leikun sisämita	[mm] 6	6	6	6
Iimantarve kuormiituna	[l/s] 4,5	4,5	5,0	5,0
Paino (ilman tarvikkaita) n.	[kg] 0,37	0,32	0,37	0,32



Laitteen osat

- 1 Työkaluupidin
- 2 Kiinnitysalue
- 3 Leikkilut, kertosuunta: oikea 
- 4 Leikkilut, kertosuunta: vasen . Vain laitteissa, joissa on 
- 5 Ilman poistoaukko äänenvaimentimien*

*Lisätarvike
Kuvissa esitetyt ja selostetut lisävarusteet eivät aina kuulu toimitukseen.

- Käytä kiinnityslaippaa kiinnittäessäsi sisäänrakennettava moottori puristuslaitteeseen ja ota huomioon puristuslaitteen turvaohjeet.

- Älä ylikuormita sisäänrakennettavan moottorin kiinnitysalueita.
- Bosch takaa laitteen moitteettoman toiminnan ainoastaan jos käytät alkuperäistarvikkeita.

Lisätarvike

Leikkurysä 3 603 386 002
Äänenvaimennin 3 607 000 016
Kiinnityslaippa 180 W 3 605 700 044
Kiinnityslaippa 120 W 3 605 700 043
Erikois-koneistorasva
225 ml 3 605 430 009

Ilman syöttö

Syötettävän ilman tulee olla vapaa vieraisista esineistä ja kosteudesta, jotta laite säästyysi vaurioilta. Ilkaantumiselta ja ruostumiselta.

Paineliman valvontayksikön käyttö on välttämätöntä.

Kaikkien kalusteiden, liitäntäjohtojen ja letkujen täytyy soveltua paineelle ja tarvittavalle ilmamäärälle.

Väitä tulojohtojen supistamista puristamalla, taivuttamalla tai venyttämällä!

Tarkista epävarmoissa tilanteissa paine ilman syöttöpuolella manometrilla laitteen käytössä.

Valvontayksikkö

Valvontayksikkö takaa paineliman-työkaluun moitteettoman toiminnan.

Se koostuu kolmesta pääosasta:

- Suodatin vedenerottimella,
- Painealennusventiili painemittareineen, – sivuvoitelulaite.

Sivuvoitelulaitteessa käytettävä voiteluaine: SAE 10/SAE 20 voiteluöljy.

Älä käytä paloöljyä tai dieselöljyä.

Säädä sivuvoitelulaite niin, että ilman tuloaukkoon muodostuu ohut öljykalvo.

Noudata valvontayksikön käyttöohjetta.



Työturvallisuus



Vaaraton työskentely laitteella on mahdollista ainoastaan, luettuasi huolellisesti käyttö- ja turvaohjeet sekä seuraamalla niiden ohjeita tarkasti.

Lisäksi on huomioitava kappaletta *Turvaohjeita paineliman-työkaluja varten*.

Ennen ensimmäistä käyttöä sinun tulisi saada käyttännön opastusta.

- **Paineliman syötön katkaisu**
Katkaise paineliman syöttö työtaukojen ajaksi ja ennen koneen huoltoa sekä työkalujen vaihtoa.
- Pidä kädet loitolla pyörivästä työkaluupitimestä sekä vaihtotyökaluista. Vaihtotyökaluun katketessa saattavat ympäristöön sinkoutuvat sirpaleet aiheuttaa loukkaantumisia.
- **Ole varovainen ahtaissa työkohteissa**
Reaktiivoimat voivat aiheuttaa puristusvammoja.
- **Älä ylikuormita laitetta.**
Työskentele ilmoitettua nimellispainetta käyttäen. Kaikkien tarvikkeiden, yhdysojtojen ja letkujen tulee soveltua käytettävälle paineelle ja tarvittavalle ilmamäärälle.

Ennen käyttöönottoa

Kiinnitä sisäänrakennettava moottoria ainoastaan mainituista kiinnitysalueesta **2** ja käytä mahdollisuuskuksien mukaan koko kiinnitysalueita. Mitä pienempi kiinnitysalue on sitä suuremmat ovat siihen kohdistuvat puristusvoimat.

- Älä ylikuormita sisäänrakennettavan moottorin kiinnitysalueita.

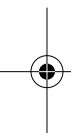
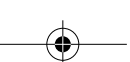



Huolto ja puhdistus

Katkaise ilmantulo ennen kaikkia latteesen kohdistuvia töitä.

Pidä aina laite ja istukka puhtaana.

Tämä laite on suunniteltu, valmistettu ja testattu erittäin huolellisesti. Mikäli siinä siltä huolimatta ilmenee jokin vika, anna vain BOSCH-huoltoilikkeeseen suorittaa tarvittavat korjaukset.

Ilmoita ehdottomasti laitteen 10-numeroinen tilausnumero kaikissa kyselyissä ja varaosatilauksissa!



Voitelu

Voiteluaine:
Erikois-koneistorasva
225 ml. 3 605 430 009
Moottoriöljy SAE 10/SAE 20

Pese koneisto pesubensiinillä ja voitele erikois-koneistorasvalla ensimmäisen kerran n. 150 käyttötunnin jälkeen ja sitten 300 käyttötunnin välein.

Bosch-huolto hoitaa nämä työt nopeasti ja luotettavasti.

Huolehdi voitelu- ja puhdistusaineista ympäristötä ajatellen. Ota huomioon viralliset säädökset.

Takuu

Myönämme Bosch-laitteille lain- ja maakohtaisien määräysten mukaisen takuun (esitettävä lasku tai toimitustodiste).

Takuu koskee raaka-aine- ja valmistusvirheitä. Takuualkaa alkaa koneen ostopäivästä.

Mahdollisen takuukorjauksen yhteydessä pyydämme Teitä esittämään ostokuulin tai vastaavan todisteen ostopäivästä.

Takuu raukeaa, jos jokin nnu kuin valtuutettu huoltoliike ryhtyy korjaustoimenpiteisiin takuun aikana.



Ympäristönsuojelu

Raaka-aineen uusiokäyttö jätehuollon asemasta

Nämä käyttöohjeet on valmistettu kloorittomasti valkaistusta uusiopaperista.

Laitte, tarvikkeet ja pakkaus pitäisi hävittää ympäristöystävällisesti toimittamalla ne kierrätykseen.



Teollisuustyökälukumppani

BOSCH KESKUSHUOLTO

Pakkalantie 21 A

01510 Vantaa

☎ 09-27 053 461

Fax 09-8 702 318

Valmistajan lauseke

Valmistajan lauseke 98/37/EY mukaan (ETA):

Tämä laite on tarkoitettu vain sisään rakennettavaksi toiseen koneeseen tai käytettäväksi toisen koneen tai toisten koneiden yhteydessä. Käyttöönotto on kielletty kunnes loppuotoon standardimukaisuus ohjeen 98/37/EY määräyksiin on todettu.

Dr. Gerhard Felten

Dr. Eckerhard Strögen

ppa Felten i.v. Mörke

Robert Bosch GmbH, Geschäftsbereich Elektrowerkzeuge



Painelimatyökälujen turvallisuusohjeet



- Huomi Loukkaantumisten estämiseksi painelimatyökäluja käytettäessä on huomioitava seuraavat yleiset turvatoimenpiteet.
- Lue ohjeet tarkasti ennen koneen käyttöä ja noudata ohjeita työn aikana.
- Pidä aina työpaikka puhtaana.**
Työpaikan epäjäätjesyys aiheuttaa vahingoittamista.
 - Ota ympäristövaikutukset huomioon**
Valitse työkohte huvin. Älä työskentele räjähdyssä tai ympäristössä.
 - Pidä lapset loitolla työalueelta**
Pidä sivulliset loitolla työalueelta.
 - Säilytä kone ja työkalut turvallisesti**
Kone ja työkalut, jotka eivät ole käytössä, tulee säilyttää kuivassa, lukitussa tilassa lasten ulottumattomissa.
 - Tarkista paineliman syötö**
Tarkista säännöllisesti paineliman syötö. Kaikkien kalusteiden liitäntäjohtojen ja leikkujen tulee olla soveltuva käytettävälle paineelle ja ilmamäärälle. Suojaa leikurit taittumiselta, supistamiselta, kuumuudelta ja teräviltä reunoilta. Anna välittömästi kunnostaa vaurioituneet leikurit ja liittimet ja kiristä leikkurikiristimet hyvin. Puutteellinen liman syötö saattaa johtaa ympäristä puskavaan painelimalaikkuun, joka aiheuttaa loukkaantumisia. Ilmavirrassa pyörivät lastut ja pöly voivat johtaa vakaviin silmävaurioihin.
 - Käytä oikeaa konetta ja työkalua**
Älä käytä liian heikkoa konetta tai lisäätettä raskaitin töihin. Käytä konetta ainoastaan niihin tarkoituksiin ja töihin, johon se on tarkoitettu käytettäväksi.
 - Pukeudu asianmukaisesti**
Älä käytä liian väliä vaatteita tai koruja, jotka voivat tarttua koneen liikkuviin osiin. Käytä huusverkkoa, jos sinulla on pitkät hiukset. Ulkona työskennellessä suosittelemme käyttämään luisumattomia jalkineita.
 - Käytä suojalaseja**
Käytä hengityssuojainta, jos työssä muodostuu pölyä.
 - Varmista työkalupaleen kiinnitys**
Käytä puristimia tai ruuvipenkkiä työkalupaleen kiinnittämiseen. Työkappale pysyy näin paremmin paikallaan kuin käsin pidettynä ja molemmat kädet vapautuvat koneen käyttöön.
 - Varmista tukeva seisoma-asento**
Vältä epänormaaleja asentoja, seisoo tukevasti ja huolehdi koko ajan tasapainostasi.
 - Pidä hyvää huolta koneista ja työkaluista**
Pitämällä kone puhtaana ja työkalut terävinä varmistat turvallisen työskenteilyn ja parhaan mahdollisen tuloksen. Noudata turvallisuusohjeita ja työkalujen vaihto-ohjeita. Pidä käsikahvat kuivina, öljyttöminä ja rasvattomina.
 - Paineliman syötön katkaisu**
Kaikkaise paineliman syötön työtaukojen ajaksi ja ennen koneen huoltoa sekä työkalujen vaihtoa.
 - Älä unohda työkaluvainimia koneeseen**
Tarkista ennen koneen käynnistämistä, että kaikki vainimet ja säätötyökäluet on poistettu.
 - Vältä koneen tahatonta käynnistymistä**
Älä koskaan kannna paineliman syötöön liitettyä konetta sormi käynnistyskytkimellä. Tarkista, että koneen käynnistyskytkin ei ole käynniasennossa, ennen kuin liität koneen painelimasyytöön.
 - Ole aina tarkkavainen**
Harkitse työäsi tarkasti. Käytä tervettä järjkeä. Älä käytä konetta alet pysty keskittymään työhösi.
 - Tarkista koneesi kunto**
Tarkista koneesi suojavarusteiden tai lievästi vaurioituneiden osien moitteeton ja asiantunneen toiminta ennen koneen käyttöönottoa. Tarkista, että koneen kaikki liikkuvat osat toimivat oikein, eivät ole puristuksessa eivätkä välissä. Kaikkien osien tulee olla oikein asennettuja ja täytettä koneen moitteettomalle toiminnalle asetettavat ehdot. Vioittuneet suojavarusteet ja osat tulee korjauttaa tai vaihtaa asianmukaisesti merkkitarjannolla, ellei käyttöohjeessa mainita toisin. Viallinen käynnistyskytkin täytyy aina vaihtaa merkkitarjannolla. Älä koskaan käytä konetta, jonka käynnistyskytkin ei toimi moitteettomasti.
 - Huomio!**
Käytä oman turvallisuutesi takia ainoastaan käyttöohjeessa mainittuja tarvikkeita ja lisäätteita. Muiden kuin käyttöohjeessa tai luettelossa mainittujen vaihtotyökälujen tai lisäätteiden käyttö saattaa johtaa loukkaantumiseen.
 - Ainoastaan ammattihenkilö saa suorittaa korjauksia**
Tämä painelimatyökälu täyttää asiankuuluvat turvallisuusnäätärykset. Ainoastaan ammattihenkilö saa suorittaa korjauksia, muuten saattaa käyttäjälle aiheuttaa onnettomuuskas.
 - Säilytä turvaohjeet helposti saatavilla.**

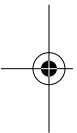
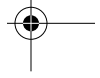
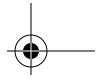
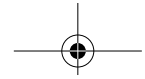

**Χαρακτηριστικά εργαλείου**

GR

Πνευματικός κινητήρας εσωτερικής προσαρμογής 180 W

Κωδικός αριθ 0 607 953 308	... 309	... 310	... 311	... 312	... 313
Όνομ. στροφές, χωρίς φορτίο	[min ⁻¹] 820	1 250	1 700	3 000	5 400	660
Εξουδετέρωση ροπής στρέψης	[Nm] 8,0	5,3	3,7	2,1	1,1	7,5
Αποδιδόμενη ισχύς	[W] 180	180	180	180	180	160
Διεύθυνση περιστροφής	↺	↺	↺	↺	↺	↺
Υποδοχή εργαλείου	3/8"-24 UNF-2A	●	●	●	●	●
Όνομαστική πίεση	[bar/psi] 6,3/90	6,3/90	6,3/90	6,3/90	6,3/90	6,3/90
Σύνδεση σωλήνα	G 1/8"	G 1/8"	G 1/8"	G 1/8"	G 1/8"	G 1/8"
Εσωτερική διατομή σωλήνα	[mm] 6	6	6	6	6	6
Κατανάλωση αέρα υπό φορτίο	[l/s] 6,0	6,0	6,0	6,0	6,0	7,2
Βάρος (χωρίς εξαρτήματα) περ.	[kg] 0,58	0,58	0,58	0,50	0,50	0,64

Πνευματικός κινητήρας εσωτερικής προσαρμογής 180 W

Κωδικός αριθ 0 607 953 314	... 315	... 316	... 317	... 326
Όνομ. στροφές, χωρίς φορτίο	[min ⁻¹] 1 050	1 400	2 600	4 600	2 000
Εξουδετέρωση ροπής στρέψης	[Nm] 5,1	3,5	2,0	1,0	3,1
Αποδιδόμενη ισχύς	[W] 160	160	160	160	180
Διεύθυνση περιστροφής	↺	↺	↺	↺	↺
Υποδοχή εργαλείου	3/8"-24 UNF-2A	●	●	●	●
Όνομαστική πίεση	[bar/psi] 6,3/90	6,3/90	6,3/90	6,3/90	6,3/90
Σύνδεση σωλήνα	G 1/8"	G 1/8"	G 1/8"	G 1/8"	G 1/8"
Εσωτερική διατομή σωλήνα	[mm] 6	6	6	6	6
Κατανάλωση αέρα υπό φορτίο	[l/s] 7,2	7,2	7,2	7,2	6,0
Βάρος (χωρίς εξαρτήματα) περ.	[kg] 0,64	0,64	0,56	0,56	0,58



3 609 929 498 • 99.10

Πνευματικός κινητήρας εσωτερικής προσαρμογής 120 W

Κωδικός αριθ 0 607 954 304	... 305	... 306	... 307
Όνομ. στροφές, χωρίς φορτίο	[min ⁻¹] 2 200	4 900	1 850	4 100
Εξουδετέρωση ροπής στρέψης	[Nm] 2,1	1,0	2,0	0,9
Αποδιδόμενη ισχύς	[W] 120	120	100	100
Διεύθυνση περιστροφής	↺	↺	↺	↺
Υποδοχή εργαλείου	3/8"-24 UNF-2A	●	●	●
Όνομαστική πίεση	[bar/psi] 6,3/90	6,3/90	6,3/90	6,3/90
Σύνδεση σωλήνα	G 1/8"	G 1/8"	G 1/8"	G 1/8"
Εσωτερική διατομή σωλήνα	[mm] 6	6	6	6
Κατανάλωση αέρα υπό φορτίο	[l/s] 4,5	4,5	5,0	5,0
Βάρος (χωρίς εξαρτήματα) περ.	[kg] 0,37	0,32	0,37	0,32



Μέρη εργαλείου

- 1 Υποδοχή εργαλείου
- 2 Περιοχή σύσφιξης
- 3 Σύσφιξη σωλήνα για περιστροφή προς τα δεξιά 
- 4 Σύσφιξη σωλήνα για περιστροφή προς τα αριστερά , μόνο σε μηχανήματα με 
- 5 Εξόδος αέρα με σπαστήρα*

* Εξαστήματα

Εξαστήματα που απεικονίζονται και περιγράφονται δε συνοδεύουν πάντοτε το μηχανήμα.

Εξαστήματα

Στήριγμα σωλήνα 3 603 386 002
 Σπαστήρας 3 607 000 016
 Φλάντζα στερέωσης 180 W 3 605 700 044
 Φλάντζα στερέωσης 120 W 3 605 700 043
 Ειδικό λίκρος για το σύστημα μετάδοσης κίνησης 225 ml 3 605 430 009



Για την ασφάλειά σας



Ακίνδυνη εργασία με το μηχανήμα είναι μόνο δυνατή, αν διαβάσετε εντελώς τις οδηγίες χρήσης και τις υποδείξεις ασφαλείας και τηρείτε αυστηρά τις οδηγίες που περιέχονται σ' αυτές.

Λάβετε επί πλέον υπόψην το κεφάλαιο „Υποδείξεις ασφαλείας για εργαλεία πιεσμένου αέρα“:

Πριν χρησιμοποιήσετε το μηχανήμα για πρώτη φορά ζητήστε να σας ενημερώσουν στην πράξη.

- **Διακόπτετε την παροχή αέρα**
 Διακόπτετε την παροχή αέρα όταν δε χρησιμοποιείτε το μηχανήμα καθώς και κατά τη συντήρησή του ή την αντικατάσταση των χρησιμοποιησίων εργαλείων.
- Μακριά τα χέρια σας από την περιστρεφόμενη υποδοχή του εργαλείου καθώς κι από το τοποθετημένο εργαλείο. Αν σπάζει το εργαλείο τα εκσπενδονιζόμενα θραύσματα μπορεί να προκαλέσουν τραυματισμούς.
- **Προσοχή αν εργάζεστε σε στενούς χώρους**
 Λόγω των αναπτυσσόμενων αντιδραστικών δυνάμεων μπορεί να προκληθούν τραυματισμοί από σφήνωμα ή ζούλημα.
- **Μην υπερφορτώνετε το μηχανήμα.**
 Εργάζεστε με την πίεση που αναφέρεται. Όλα τα όργανα φραγμού, οι συνδετικοί αγωγοί και οι σωλήνες πρέπει να ανταποκρίνονται στις απαιτήσεις της πίεσης και του απαιτητικού όγκου αέρα.

- Για τη σύσφιξη του κινητήρα εσωτερικής προσαρμογής σε μια διάταξη σύσφιξης χρησιμοποιήστε τη φλάντζα στερέωσης και τηρήστε τις υποδείξεις ασφαλείας της διάταξης σύσφιξης.
- Μην υπερφορτώνετε την περιοχή σύσφιξης του κινητήρα εσωτερικής προσαρμογής.
- Η Bosch εγγυάται την άψογη λειτουργία του μηχανήματος, μόνο όταν γίνεται χρήση γνήσιων εξαρτημάτων.

Παροχή αέρα

Για να προφυλαχτεί το μηχανήμα από βλάβες, βρωμιές και σκουριά πρέπει ο εισερχόμενος αέρας να μην περιέχει ξένα σώματα και υγρασία.

Είναι απαραίτητη μια μονάδα συντήρησης της διάταξης πιεσμένου αέρα.

Όλα τα όργανα φραγμού, οι συνδετικοί αγωγοί και οι σωλήνες πρέπει να ανταποκρίνονται στις απαιτήσεις της πίεσης του απαιτητικού όγκου αέρα.

Αποφεύγετε τις στενώσεις των αγωγών, π.χ. από ζούλημα, δίπλωμα ή τεντώμα!

Αν έχετε αμφιβολίες, μετρήστε την πίεση στη είσοδο του αέρα μ' ένα μανόμετρο.

Μονάδα συντήρησης

Η μονάδα συντήρησης εξασφαλίζει την άψογη λειτουργία των εργαλείων πιεσμένου αέρα και αποτρέπει κυρίως από τρία βασικά μέρη:

- Φίλτρο με διαχωρητήρα νερού,
- Βαλβίδα μείωσης πίεσης με μανόμετρο,
- Λαδωτήρι πιεσμένου αέρα.

Λιπαντικό στο λαδωτήρι πιεσμένου αέρα:

Λάδι κινητήρα SAE 10/SAE 20.

Μη χρησιμοποιείτε (φωτιστικό) πετρέλαιο ή πετρέλαιο νηξελαικινητήρων.

Ρυθμίστε το λαδωτήρι πιεσμένου αέρα κατά το ίδιο τρόπο, ώστε στην έξοδο του αέρα να σχηματίζεται μια λεπτή ταινία λιπαντικού.

Προσέξτε τις οδηγίες χειρισμού της μονάδας συντήρησης.

Πριν τη θέση του εργαλείου σε λειτουργία

Στερεώστε τον κινητήρα εσωτερικής προσαρμογής εντός της αναφερόμενης περιοχής σύσφιξης **2** και εκμεταλλευτείτε κατά το δυνατό ολόκληρη την περιοχή σύσφιξης. Όσο μικρότερη είναι η περιοχή σύσφιξης, τόσο περισσότερο επιδρούν οι δυνάμεις σύσφιξης.

- Μην υπερφορτώνετε την περιοχή σύσφιξης του κινητήρα εσωτερικής προσαρμογής.



Συναρμολόγηση

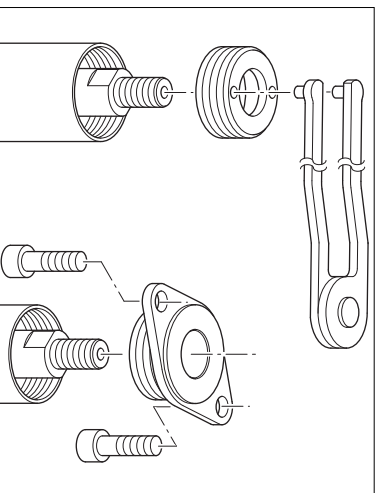

Ξεβιδώστε τελεσίως (αριστερότερο σημειωμάτι) το στερεωτικό δακτύλιο μ' ένα γαντζόκλειδο και βιδώστε τη φλάντζα στερέωσης. Ο κινητήρας εσωτερικής προσαρμογής μπορεί να βιδωθεί στη φλάντζα στερέωσης με δυο βίδες.

Θέση σε Λειτουργία

Το μηχανήμα λειτουργεί με το βέλτιστο τρόπο με υπέρταση 6,3 bar (90 psi), μετρημένη στην είσοδο του αέρα, όταν το μηχανήμα βρίσκεται σε λειτουργία.

Θέση σε Λειτουργία/εκτός Λειτουργίας

Σε περίπτωση που το μηχανήμα δεν „παιρνει εμπρός“, π.χ. όταν δεν είχε λειτουργήσει για πολύ καιρό, διακόψτε την παροχή αέρα και περιστρέψτε την υποδοχή εργαλείου **1** με το χέρι. Μ' αυτόν τον τρόπο εξουδετερώνονται οι δυνάμεις συνοχής.



Αν διακοπεί η παροχή αέρα ή μειωθεί η πίεση λειτουργίας διακόψτε τη λειτουργία του μηχανήματος. Ελέγξτε την πίεση λειτουργίας και ξεκινήστε πάλι με τη βέλτιστη πίεση.

Η θέση του μηχανήματος σε λειτουργία κι εκτός λειτουργίας διεξάγεται αντιστοίχως με άνοιγμα ή διακοπή της προφοδοσίας με πεπιεμένο αέρα.

Υποδείξεις για την Εκτέλεση εργασιών

Διακόψτε την παροχή του αέρα πριν διεξάγετε οποιαδήποτε εργασία στο ίδιο το μηχανήμα.

Φορά προστασίας

Συνδέστε την προφοδοσία με πεπιεμένο αέρα, ανάλογα με την επιθυμητή φορά περιστροφής, στο δεξιό ή αριστερό στήριγμα σωλήνα.

Ξαφνικά εμφανιζόμενες επιβραδύνσεις έχουν σαν αποτέλεσμα την ισχυρή μείωση του αριθμού στροφών ή την ακινητοποίηση του μηχανήματος, δεν βλάπτουν όμως τον κινητήρα.

62

Τύπος 0 607 953 308 / ... 309 / ... 310 /

... 311 / ... 312 / ... 326

Τύπος 0 607 954 304 / ... 305

Περιστροφή προς τα δεξιά:

Συνδέστε το σωλήνα παροχής αέρα στη σύνδεση σωλήνα **3**.



Σε υψηλές ροπές στρέψεις είναι απαραίτητη η ανάπτυξη ανάλογων αντιστροφών δύναμης (κοντράρισμα).

Το κοντράρισμα μπορεί να αναπτυχθεί καλύτερα με μια διάταξη σύσφιξης στην περιοχή **2**.

Φροντίστε, η πρόσθετη λαβή ή η διάταξη σύσφιξης να συγκρατούν το μηχανήμα ασφαλώς και γερά.

Τύπος 0 607 953 313 / ... 314 / ... 315 /

... 316 / ... 317

Τύπος 0 607 954 306 / ... 307

Περιστροφή προς τα δεξιά:

Συνδέστε το σωλήνα παροχής αέρα στη σύνδεση σωλήνα **3**.

Περιστροφή προς τα αριστερά:

Συνδέστε το σωλήνα παροχής αέρα στη σύνδεση σωλήνα **4**.



Σε υψηλές ροπές στρέψεις είναι απαραίτητη η ανάπτυξη ανάλογων αντιστροφών δύναμης (κοντράρισμα).

Το κοντράρισμα μπορεί να αναπτυχθεί καλύτερα με μια διάταξη σύσφιξης στην περιοχή **2**.

Φροντίστε, η πρόσθετη λαβή ή η διάταξη σύσφιξης να συγκρατούν το μηχανήμα ασφαλώς και γερά.

Ροπή στρέψης

Η ροπή στρέψης ρυθμίζεται μέσω της πίεσης λειτουργίας.

Ο αναφερόμενος αριθμός στροφών χωρίς φορτίο εμφανίζεται όταν ο αναδότηρας είναι μονταρισμένος. Αν απομακρυνθεί ο αναδότηρας, τότε πρέπει να επανελεγχθεί ο αριθμός στροφών. Τυχόν υπερυψηλός αριθμός στροφών πρέπει να περιοριστεί μ' ένα σπρανγδαλιστικό πηνίο στο ύψος του ονομαστικού αριθμού στροφών.

Υπερυψηλοί αριθμοί στροφών προκαλούν περττό θόρυβο και συντομεύουν τη διάρκεια ζωής του μηχανήματος.

Διοχέτευση του εξερχόμενου αέρα

Μετά την αφαίρεση του σγαστήρα **5** ο εξερχόμενος αέρας μπορεί να διοχετευθεί με σύνδεση ενός σωλήνα στην έξοδο αέρα.

Πλεονεκτήματα:

- Μείωση θορύβου,
- καμιά ρύπανση του χώρου εργασίας από σπρωδιδόμενη σκόνη,
- διοχέτευση του αέρα.

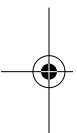



Συντήρηση και καθαρισμός

Διακρίνετε την παροχή του αέρα πριν διεξάγετε οποιαδήποτε εργασία στο ίδιο το μηχάνημα.

Διαπρίετε πάντα το μηχάνημα και την υποδοχή εργαλείου σε καθαρή κατάσταση.

Αν παρόλες τις επιμελημένες μεθόδους κατασκευής και ελέγχου σταματήσει κάποτε το εργαλείο, τότε η επισκευή του πρέπει να ανατεθεί σε αναγνωρισμένο συνεργείο ηλεκτρικών συσκευών της BOSCH.

Όταν ζητάτε διασφαητικές πληροφορίες και όταν παραγγέψετε ανταλλακτικά, παρακαλούμε να αναφέρετε οπωσδήποτε το δεκαμήφιο κωδικό αριθμό.



Λιπανση

Λιπαντικό:
Ειδικό λίπος για το σύστημα μετάδοσης κίνησης 225 ml 3 605 430 009
Λάδι κινητήρα SAE 10/SAE 20

Καθαρίστε το σύστημα μετάδοσης κίνησης με βεβίλη καθαρισμού και λιπάντε το με το ειδικό λίπος για το σύστημα μετάδοσης κίνησης μετά απο τις πρώτες 150 ώρες λειτουργίας περίπου στη συνέχεια επαναλαμβάνετε την παραπάνω διαδικασία κάθε 300 ώρες λειτουργίας περίπου. Οι υπηρεσίες εξυπηρέτησης πελατών της Bosch διεξάγουν την εργασία αυτή γρήγορα και ασφαλώς.

Αποσέρνετε τα λιπαντικά υλικά και τα υλικά καθαρισμού με φιλικό προς το περιβάλλον με τρόπο. Δίστε προσοχή στις νομικές οδηγίες.

3 609 929 498 • 99.10

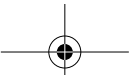

Προστασία περιβάλλοντος



Ανακύκλωση πρώτων υλών αντι απόσυρση απορριμμάτων

Το μηχάνημα, τα εξαρτήματα και η συσκευασία θα πρέπει να απορρίπτονται προς επεξεργασία κατά τρόπο που δεν βλάπτει το περιβάλλον.

Αυτό το τεύχος οδηγίων έχει τυπωθεί σε ανακυκλωμένο χαρτί, λευκασμένο χωρίς χλώριο.



Συνεργάτης για Βιομηχανικά εργαλεία

Robert Bosch A.E.
Κηφισού 162
12131 Περιστέρι-Αθήνα

☎ (01) 5770081-89
FAX (01) 5770080
ABZ SERVICE A.E.
☎ (01) 5770081-83
☎ (01) 5701375-78
FAX (01) 5773607

Δήλωση κατασκευαστή

Δήλωση κατασκευαστή σύμφωνα με 98/37/EK:

Το παρόν προϊόν προορίζεται αποκλειστικά για εγκατάσταση σε μια άλλη μηχανή ή για συναρμολόγηση με άλλη μηχανή ή με άλλες μηχανές. Απαγορεύεται η λειτουργία του μέχρι να εξακριβωθεί η συμβατικότητα του τελικού προϊόντος με την Κατευθυντήρια Γραμμή 98/37/EK.

Dr. Gerhard Felten

Dr. Eckerhard Strötgen

Robert Bosch GmbH, Geschäftsbereich Elektrowerkzeuge

Εγγύηση

Για τα εργαλεία Bosch παρέχουμε εγγύηση σύμφωνα με την (στο κάθε κράτος) ισχύουσα νομοθεσία (επιβεβαίωση αγοράς με το τιμολόγιο ή με το δεκτίο αποστολής).

Η κάλυψη βλαβών που προέρχονται απο φυσιολογική φθορά, υπερφόρτιση ή κακή μεταχείριση, δεν περιλαμβάνεται στην εγγύηση. Βλάβες που προέκυψαν λόγω ελλοματικών υλικού ή σφάλματος της κατασκευής, αποκαθίστανται με δωρεάν αντικατάσταση των ελαττωματικών ανταλλακτικών ή τη δωρεάν επισκευή.

Παράπονα γίνονται δεκτά μόνον όταν αποσταλεί το εργαλείο χωρίς να έχει ανοιχτεί στον προμηθευτή ή σ' ένα αναγνωρισμένο συνεργείο της Bosch για ηλεκτρικά εργαλεία ή εργαλεία πεπιεζμένου αέρα.





Υποδείξεις ασφαλείας για μηχανήματα πεπιεζμένου αέρα

- 1. Τιποτέτη τάξη στον τομέα της εργασίας σας**
Αρτέα στον τομέα της εργασίας σας μπορεί να επιφέρει ατυχήματα.
- 2. Λαβδίστε την πόμψη σας τις επιδόσεις του περιβάλλοντος**
Μην υπάρχει καλός φωτισμός. Μην εργάζεστε σε περιβάλλον στο οποίο υπάρχει κίνδυνος έκρηξης.
- 3. Κρατάτε σε απόσταση τα παιδιά**
Κρατάτε έξω άτομα σε απόσταση από τον τομέα που εργάζεστε.
- 4. Διαφωδύστε τα μηχανήματα και εργαλεία σε ασφαλές μέρος**
Μη χρησιμοποιούμενα μηχανήματα και εργαλεία θα πρέπει να διαφωδύγονται σ' ένα στεγνό, κλειστό κι αποδύοτο στα παιδιά χώρο.
- 5. Ελέγχετε την παροχή αέρα**
Ελέγχετε τακτικά την παροχή αέρα. Όλες οι δικαίειες, οι συνδετικοί άνωγοι κι οι σωλήνες πρέπει να επαρκούν για την πίεση και την απαιτούμενη ποσότητα αέρα. Προστατεύετε το σωλήνα από σπασίματα, στενώσεις, υπερβολική θερμότητα και κοφτερές ακμές. Φροντίστε για την άμεση επισκευή τυχόν χαλασμένων σωλήνων και συσδέσεων και σφίγγετε καλά τα περάσματα των σωλήνων. Μια ενδεχόμενη ελαττωματική παροχή αέρα μπορεί να προκαλέσει τον ανέλεγκτο εκφυσδύοισμό του σωλήνα πεπιεζμένου αέρα και να οδηγήσει σε τραυματισμούς. Στροβιλιζόμενη σκόνη ή υφέδια μπορούν να προκαλέσουν σοβαρούς τραυματισμούς των ματιών.
- 6. Χρησιμοποιείτε το σωστό εργαλείο**
Μη χρησιμοποιείτε μηχανήματα ή ανταλλάξιμα εργαλεία πύον χειρλής απόδουης για βάρεις εργαλεία. Μη χρησιμοποιείτε τα μηχανήματα για σκοπούς κι εργασίες για τις οποίες δεν προορίζονται.
- 7. Φοράτε κατάλληλα ρούχα εργασίας**
Μη φοράτε φορδιά ρούχα ή κοσμήματα. Αυτά μπορούν να εμπέχτουν στα κινούμενα μέρη των μηχανημάτων. Αν έχετε μακριά μαλλιά, φοράτε δίχτυ μαλλιών. Κατά τη διεξάγωγη εργασίας στην ύπαιθερο συσταίεται η χρήση αντιαποδύητικών υποδημάτων.
- 8. Φοράτε προστατευτικά γυαλιά**
Φοράτε αντανευστική προσταίδα (μάσκα) κατά τη διάρκεια εργασιών που δημιουργούν σκόνη.
- 9. Ασφαδίστε το υπό καταργασία τμήδύο**
Κάντε χρήση διατάξεων σφύσσης ή μέκνης για τη συγκράτηση του υπό καταργασία τεμαχίου. Μ' αυτόν τον τρόπο συγκρατείται ασφαλέστερα παρά με το χέρι και επί πύδου επιτρέπεται το χειρισμό της μηχανής και με τα δύο χέρια.
- 10. Φροντίστε για την ασφαλή στήση του σώματος σας**
Αποφύγετε κάθε μη φυσιολογική στήση του σώματος σας. Φροντίστε για την ασφαλή στήση του σώματος σας και κρατάτε συνεχώς την ισορροπία σας.
- 11. Να συντηρείτε προσεκτικά τα μηχανήματα και τα εργαλεία**
Διατηρείτε πάντοτε τα μηχανήματά σας καθαρά και τα εργαλεία σας κοφτερά για να μπορείτε έτοι να εργάζεστε καλά και ασφαλάς. Τιρείτε τις οδηγίες συντήρησης και τις υποδείξεις αντικατάστασης των εργαλείων. Διατηρείτε τις χειροαδέες στεγνές και καθαρές από λάδια και λίπη.
- 12. Διακόπτετε την παροχή αέρα**
Διακόπτετε την παροχή αέρα όταν όταν δε χρησιμοποιείτε το μηχανήμα καθώς και κατά τη συντήρησή του ή την αντικατάσταση των χρησιμοποιούμενων εργαλείων.
- 13. Μην αφήνετε αναρμολογημένα κλειδιά εργαλείων**
Πριν θέσετε το μηχανήμα σε λειτουργία ελέγτε, άν έχουν πρόγμμηστρομακρυνθεί όλα τα κλειδιά και τα εργαλεία πύδμησης.
- 14. Αποφύγετε μια ενδεχόμενη σκόνουσα εκκίνηση**
Μη μεταφέρετε ποτέ ένα μηχανήμα που είναι συνδεδέμενο στην παροχή αέρα ένυστες το δάκτυλό σας στην σκανδάλη. Πριν τη σύνδεση του μηχανήματος στην παροχή αέρα βεβαιώσετε ότι αυτό έχει τρέβει εκτός λειτουργίας.
- 15. Να είσαστε πάντοτε προσεκτικοί**
Προσέχετε την εργασία σας. Εργαίετε λογικά. Μη χρησιμοποιείτε το μηχανήμα άν είσθε ασηρημένοι.
- 16. Ελέγχετε το μηχανήμα σας για ενδεχόμενες βλάβες**
Πριν χρησιμοποιήσετε το μηχανήμα πρέπει να διεξάγετε προσεκτικό έλεγχο, άν οι προστατευτικές διατάξεις ή τυχόν ελαφρύς φθαρήμενα μέρη λειτουργούν άμωρα και άμωφωρα με τον προορισμό τους. Ελέγτε την άμωρη λειτουργία των κινούμενων τμημάτων, άν αυτά σκανδύουν, καθώς κι αν υπάρχουν χαλασμένα εξαρτήματα. Όλα τα μέρη πρέπει να είναι σωστά συναρμολογημένα, για να εξασφαλίζουη την άμωρη λειτουργία του μηχανήματος.
- Χαλασμένες προστατευτικές διατάξεις και εξαρτήματα πρέπει να επισκεδύονται κατάλληλα από ένα αναγνωρισμένο συνεργείο ή να αντικατασταίνονται, εκτός αν στις οδηγίες χρήσης προβάίεται κάτι το διαφορετικό. Χαλασμένοι διακόπτες πρέπει να αντικατασταίνονται από κάποιο συνεργείο εξμπτήρησης πεδάρτων (SERVICE). Μη χρησιμοποιείτε μηχανήματα των οποίων ο διακόπτης ON/OFF δε λειτουργεί.**
- 17. Προσοχή!**
Για χάρη της προσταίηκής σας ασφαλείας χρησιμοποιείτε μόνο εξαρτήματα και συμπληρωματικά μηχανήματα που αναδέρονται στις οδηγίες χρήσης. Η εργασία με εργαλεία ή συμπληρωματικά μηχανήματα διαφορετικά από εκείνα που συσταίνονται στις οδηγίες χρήσης ή στον αντίστοιχο πύνακα μπορεί να σημάκει για σας προσωπικό κίνδυνο τραυματισμού.
- 18. Επισκευές μόνο από ειδικό**
Αυτό το μηχανήμα πεπιεζμένου αέρα εκκλήρωει στις σχετικές διατάξεις ασφαλείας. Ενδεχόμενες επισκευές επιτρέπεται να διεξάγονται μόνο από κάποιον ειδικό, διαφορετικά μπορεί να προκύβουν ατυχήματα σε βάρος του χρήστη.

Διαφωδύστε καλά τις υποδείξεις ασφαλείας.

**Teknik veriler**

TR

İçe yerleştirilmiş havalı motor 180 W

Sipariş numarası 0 607 953 308	... 309	... 310	... 311	... 312	... 313
Boşta ki devir sayısı	[min ⁻¹] 820	1 250	1 700	3 000	5 400	660
Boğulmatıkanna momenti	[Nm] 8,0	5,3	3,7	2,1	1,1	7,5
Çıkış gücü	[W] 180	180	180	180	180	160
Dönme yönü	↻	↻	↻	↻	↻	↻
Uç kovani	3/8"-24 UNF-2A ●	●	●	●	●	●
Nominal basınç	[bar/psi] 6,3/90	6,3/90	6,3/90	6,3/90	6,3/90	6,3/90
Hortum bağlantısı	G 1/8"	G 1/8"	G 1/8"	G 1/8"	G 1/8"	G 1/8"
Hortum iç genişliği	[mm] 6	6	6	6	6	6
Yükteki hava tüketimi	[l/s] 6,0	6,0	6,0	6,0	6,0	7,2
Yaklaşık ağırlık (aksesuarsız)	[kg] 0,58	0,58	0,58	0,50	0,50	0,64

İçe yerleştirilmiş havalı motor 180 W

Sipariş numarası 0 607 953 314	... 315	... 316	... 317	... 326
Boşta ki devir sayısı	[min ⁻¹] 1 050	1 400	2 600	4 600	2 000
Boğulmatıkanna momenti	[Nm] 5,1	3,5	2,0	1,0	3,1
Çıkış gücü	[W] 160	160	160	160	180
Dönme yönü	↻	↻	↻	↻	↻
Uç kovani	3/8"-24 UNF-2A ●	●	●	●	●
Nominal basınç	[bar/psi] 6,3/90	6,3/90	6,3/90	6,3/90	6,3/90
Hortum bağlantısı	G 1/8"	G 1/8"	G 1/8"	G 1/8"	G 1/8"
Hortum iç genişliği	[mm] 6	6	6	6	6
Yükteki hava tüketimi	[l/s] 7,2	7,2	7,2	7,2	6,0
Yaklaşık ağırlık (aksesuarsız)	[kg] 0,64	0,64	0,56	0,56	0,58

3 609 929 498 • 99.10

İçe yerleştirilmiş havalı motor 120 W

Sipariş numarası 0 607 954 304	... 305	... 306	... 307
Boşta ki devir sayısı	[min ⁻¹] 2 200	4 900	1 850	4 100
Boğulmatıkanna momenti	[Nm] 2,1	1,0	2,0	0,9
Çıkış gücü	[W] 120	120	100	100
Dönme yönü	↻	↻	↻	↻
Uç kovani	3/8"-24 UNF-2A ●	●	●	●
Nominal basınç	[bar/psi] 6,3/90	6,3/90	6,3/90	6,3/90
Hortum bağlantısı	G 1/8"	G 1/8"	G 1/8"	G 1/8"
Hortum iç genişliği	[mm] 6	6	6	6
Yükteki hava tüketimi	[l/s] 4,5	4,5	5,0	5,0
Yaklaşık ağırlık (aksesuarsız)	[kg] 0,37	0,32	0,37	0,32



Aletin elemanları

- 1 Uç kovanı
- 2 Sıkma kapasitesi
- 3 Sağa dönüş hortum bağlantısı
- 4 Sola dönüş hortum bağlantısı sadece dönüşlü aletlerde
- 5 Susturuculu hava çıkışı*

* Aksesuar

Resmini gördüğünüz veya tanımlanmış aksesuarın bir kısmı teslimat kapsamında değildir.

- Montaj motorunu sıkma (germe) tertibatında sıkarken tespit fişasını kullanın ve sıkma tertibatının güvenlik talimatına uyun.

- Montaj motorunun sıkma (germe) alanını aşırı ölçüde zorlamayın.
- Bosch, ancak orijinal aksesuarlar kullanıldığı takdirde aletin kusursuz işlev göreceğini garanti eder.

Hava beslemesi

Aleti, hasar, kirlenme ve pas oluşumundan korumak için, giren havanın yabancı cisim ve nemden arındırılmış olması gerekir.

Bir basınçlı hava kontrol ünitesinin kullanılması gereklidir.

Tüm armatürler, bağlantı boruları ve hortumlar, basınca ve gerekli hava miktarına uygun olarak döşenmiş olmalıdır.

Ezilme, kırılma/kıvrılma veya çökme nedeniyle besleme hatlarında meydana gelebilecek deralmalardan sakınılı

Şüpheli hallerde, alet çalışır durumdayken, hava girişindeki basıncı bir manometre ile kontrol edin.

Kontrol ünitesi

Kontrol ünitesi, pnömatik aletlerin işlevlerini kusursuz olarak yerine getirmelerini sağlar.

Bu ünite, üç ana parçadan oluşur:

- Su separatorlu filtre,
- Manometreli basınç düşürme valfi,
- Bugulu yağlayıcı.

Bugulu yağlayıcıdaki yağlama maddesi: SAE 10/SAE 20 motor yağı.

Gazyağı veya mazot kullanmayın.

Bugulu yağlayıcıyı, hava çıkışında ince bir yağ filmi oluşacak şekilde ayarlayın.

Kontrol ünitesinin kullanma talimatına riayet edin.



Güvenliğiniz için



Alete tehlikesiz bir biçimde çalışmak ancak kullanım kılavuzunu ve güvenlik talimatlarını iyice okuyup, içindekilere tam olarak uymakla mümkündür.

Ek olarak *Havali aletler için güvenlik talimatları* bölümünde belirtilen hususlara dikkatle uyulmalıdır.

Aleti ilk kez kullanmadan önce, bu işi bilen birisinin gözetiminde bir süre deneme yapın.

- **Hava besleme hatını kesin**

Aletler kullanım dışında iken, bakım sırasında ve uçları değiştirmeden önce hava besleme hatını kesin.

- Ellerinizi dönmekte olan uç kovanı ve uçtan uzak tutun. Kullanışınızın uç kırıldığı takdirde etrafa sıçrayan kırıntı ve parçalar yaralanmalara neden olabilir.

- **Dar yerlerde çalışırken dikkatli olun**

Reaksiyon momentleri sonucu ortaya çıkabilecek sıkışma ve kaymalar yaralanmalara neden olabilir.

- **Aleti fazla zorlamayın.**

Belirtilen anma basıncı ile çalışın. Bütün armatürler, bağlantı elemanları ve hortumlar basınca ve gerekli hava miktarına uygun olmalıdır.

Çalıştırmadan önce

Montaj motorunu sadece belirtilen sıkma alanından **2** tespit edin ve mümkünse sıkma aralığının tümünü kullanmaya çalışın. Sıkma alanı ne kadar küçük olursa sıkma ve germe kuvvetleri o kadar etkin olur.

- Montaj motorunun sıkma (germe) alanını aşırı ölçüde zorlamayın.



Montaj

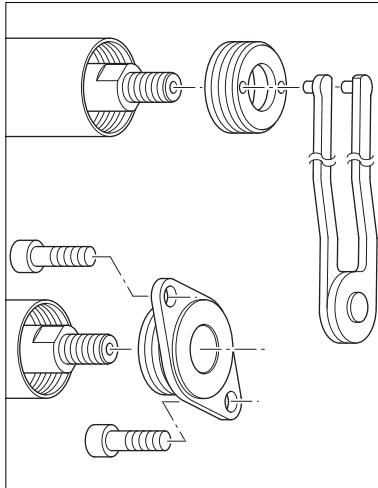

Dişli halkayı kancalı bir anahtarla sökün (dikkati sol dişli) ve tespit vidasını takın. Montaj motoru tespit flanşı üzerinden iki vida yardımı ile sıkma (germe) tertibatına vidalanabilir.

Çalıştırma

Çalışır durumunda, hava girişinde ölçülen 6,3 bar (90 psi) basınçta, alet optimum çalışır.



3 609 929 498 • 99.10

Açma/kapama

Eğer alet çalışmayacak olursa, örneğin uzun süreli dinlenmelerden sonra, hava beslemesini kesin ve uç girişini **1** elle döndürün. Böylece yapıştırıcı etkenler bertaraf edilir.



Hava besleme kesildiğinde veya işletme basıncı düştüğünde aleti kapatın. İşletme basıncını kontrol edin ve aleti optimal işletme basıncı ile tekrar çalıştırın.

Aletin açılıp kapanması basınçlı hava besleme kaynağının açılıp kesilmesiyle yapılır.

Çalışırken dikkat edilecek hususlar

Alet üzerinde yapılacak tüm çalışmalardan önce, hava beslemesini kapatın.

Dönme yönü

İsteddiğiniz dönme yönüne göre hava besleme hattını sağ veya sol hortum rakoruna bağlayın.

Ani yüklenmeler devir sayısının büyük oranda düşmesine veya durmaya neden olabilir; ancak motora zarar vermez.

Tip 0 607 953 308 / ... 309 / ... 310 / ... 311 / ... 312 / ... 326

Tip 0 607 954 304 / ... 305

Sağa dönüş:
Hava besleme hortumunu, hortum bağlantısına **3** bağlayın.

Yüksek torklarla çalışılırken buna uygun büyük karşı tutma kuvveti gereklidir.

Bu kontra tutma kuvveti **2** aralığında bir germe tertibatı ile daha iyi yaratılabilir.

İlave sapın veya germe tertibatının aleti güvenli ve sağlam bir biçimde tutmasını sağlayın.

Tip 0 607 953 313 / ... 314 / ... 315 / ... 316 / ... 317

Tip 0 607 954 306 / ... 307

Sağa dönüş:
Hava besleme hortumunu, hortum bağlantısına **3** bağlayın.

Sağa dönüş:
Hava besleme hortumunu, hortum bağlantısına **4** bağlayın.

Yüksek torklarla çalışılırken buna uygun büyük karşı tutma kuvveti gereklidir.

Bu kontra tutma kuvveti **2** aralığında bir germe tertibatı ile daha iyi yaratılabilir.

İlave sapın veya germe tertibatının aleti güvenli ve sağlam bir biçimde tutmasını sağlayın.

Tork

Tork, işletme basıncı üzerinden kontrol edilebilir.

Belirtilen boştaki devir sayısı, susturucu bağlandığında gerçekleşir. Susturucu çıkarınca devir sayısının kontrol edilmesi gerekir. Aşırı yüksek devir sayısı bir kısıcı ile anma devir sayısına düşürülmelidir.

Aşırı yüksek devir sayıları gereksiz gürültüye neden olurlar ve aletin kullanım ömrünü kısaltırlar.

Atık havanın boşaltılması

Susturucu **5** çıkarıldıktan sonra hava çıkış deliğine bir hortum bağlanarak atık hava istenen yere sevk edilebilir.

- Sağladığı avantajlar:
- Gürültü azalır,
 - Uçuşan tozların işyerini kirlenmesi önlenir,
 - Atık hava istenen yere sevk edilir.





Bakım ve temizlik

Alet üzerinde yapılacak tüm çalışmalardan önce, hava beslemesini kapatın.

Aleti ve uçları daima temiz tutun.

Titiz üretim ve test yöntemlerine rağmen alet arıza yapacak olursa, onarım, Bosch elektrikli el aletleri için yetkili bir servise yaptırılmalıdır.

Bütün başvuru ve yedek parça siparişlerinizde lütfen aletin 10 haneli sipariş numarasını mutlaka belirtin!



Yağlama

Yağlama maddesi:
Özel şanzıman yağı

225 ml..... 3 605 430 009

Motor yağı SAE 10/SAE 20

İlk defasında şanzımanı yaklaşık 150 işletim saatinden, daha sonra da her 300 işletim saatinden sonra temizleme benzini ile yıkayın ve özel şanzıman yağı ile yağlayın.

Bosch müşteri servisleri bu işleri hızla ve güvenilir biçimde yerine getirir.

Yağlama ve temizleme maddelerini çevre koruma hükümlerine uygun olarak atın. Yasal hükümlere uyun.



Garanti

Bosch elektrikli el alet için, yasal hükümler çerçevesinde, malzeme ve üretim hatalarından kaynaklanan hasarlar için garanti veriyoruz.

Normal yıpratma, aşırı zorlanma veya usulüne aykırı kullanımdan kaynaklanan hasarlar garanti kapsamında değildir.

Malzeme veya üretim hatalarından kaynaklanan hasarlar, hatalı parça veya aletin kendisinin verilmesi veya onarımı yoluyla telafi edilir.

Garantiye ilişkin talepler ancak, alet **sökülmeden** teslimatçı veya Bosch'un pnömatik veya elektrikli el aletleri müşteri servis atölyelerinden birine gönderildiği takdirde kabul edilebilir.

Çevre koruma



Çöp tasfiyesi yerine hammade kazanımı

Alet, aksesuar ve ambalaj çevre koruma hükümlerine uygun bir yenden değerlendirme işlemine tabi tutulmalıdır.

Bu kullanım talimatı da, klor kullanılmadan ağartılmış, yeniden dönüşümü kâğıda basılmıştır.



Sınai aletler-Partnerler

Robert Bosch A.S.

Ambarlar Cad. No. 4

Elektrikli El Aletleri Departmanı

Zeytinburnu-Topkapı
34761 İstanbul

☎ 5 58 24 70-74
Faks 5 58 24 49

Uyarınca üretici beyanı

98/37/AT uyarınca üretici beyanı:

Bu ürün; başka bir alet içine monte edilmek veya başka bir alet veya aletlerle birlikte monte edilmek üzere üretilmiştir. Nihai ürünün standardizasyonu 98/37/AT yönetmeliği hükümlerince tespit edilinceye kadar, ürünün işlenmeye alınması yasaktır.

Dr. Gerhard Felten

Dr. Eckehard Strötgen

ppa. Felten *i.v. Meyer*

Robert Bosch GmbH, Geschäftsbereich Elektrowerkzeuge





Havalı El Aletleri İçin Güvenlik Talimatları



Dikkati! Havalı el aletleri kullanılırken yaralanma tehlikesinden korunmak için aşağıdaki temel güvenlik talimatlarına uyulmalıdır.
Aleti kullanmadan önce bu talimatları okuyun ve belirtilen hususlara uyun.

- 1. Çalışma yerinizi düzenli tutun**
Çalışma yerindeki düzensizlik kaza tehlikesi yaratır.
- 2. Ortam koşullarını dikkate alın**
Çalıştığınız ortamda aydınlanmanın iyi olması için gereken önlemleri alın. Patlama tehlikesi olan yerlerde çalışmayın.
- 3. Çocukları çalışma alanınızdan uzak tutun**
Başkalarını çalışma alanınızdan uzak tutun.
- 4. Aletleri ve uçları güvenli biçimde saklayın**
Kullanılmayan aletleri ve uçları kuru, kapalı ve çocukların erişmeyeceği bir yerde saklayın.
- 5. Hava besleme hattını kontrol edin**
Hava besleme hattını düzenli olarak kontrol edin. Butin armatürler, bağlantılar ve hortumlar ilgili basınca ve hava miktarına uygun olmalıdır. Hortumu kırılmaya, sıkışmaya, sıcaklığa ve keskin kenarlı cisimlere karşı koruyun. Hasar gören hortumları ve kulpaları hemen onarın ve hortum kelepçelerini iyice sıkın. Hasarlı hava besleme hattı basınçlı hava hortumunun savrulmasına ve yaralanmalara neden olabilir. Çalışma yerinde uçusan tozlar ve taşlar gözlerde ağır yaralanmalara neden olabilir.
- 6. Doğru uç kullanın**
Ağır işler için düşük güçlü alet veya zayıf uçlar kullanmayın. Aletleri, kendileri için öngörülmemiş işlerde kullanmayın.
- 7. Uygun iş giysileri kullanın**
Çok bol giysi kullanmayın ve takı taşımayın. Bunlar aletlerin hareketli parçaları tarafından tutulabilir. Sağağrınız uzunsa saç koruma filesi takın. Açık havada çalışırken kaymayan iş ayakkabıları giyin.
- 8. Koruyucu gözlük kullanın**
Toz çıkaran işleri yaparken koruyucu toz maskesi takın.
- 9. İş parçasını emniyete alın**
İş parçasını sabitlemek için germe tertibatları veya bir mengece kullanın. Bu tertibatlar iş parçasını elinizden daha güvenli tutar ve siz de bu sayede aletinizi iki elinizle tutabilirsiniz.
- 10. Duruşunuzun güvenli olmasına dikkat edin**
Vücudunuz anormal biçimde durmamalıdır. Duruşunuzun güvenli olmasına dikkat edin ve daima dengeinizi koruyun.

11. Aletlere ve uçlara özenle bakın
İyi ve güvenli biçimde çalışabilmek için aletinizi temiz ve uçlarınızı keskin tutun. Bakım ve uç değiştirme talimatlarına uyun. Aletlerin sap ve tutamaklarını kuru ve yağsız tutun.

- 12. Hava besleme hattını kesin**
Aletler kullanım dışına iken, bakım sırasında ve uçları değiştirmeden önce hava besleme hattını kesin.
- 13. Aletler üzerinde yardımcı anahtar bırakmayın**
Aletleri çalıştırmadan önce uç anahtarlarının ve ayar aletlerinin çıkarılıp çıkarılmadığını kontrol edin.
- 14. Aletin yanlışlıkla çalışmamasına dikkat edin**
Hava besleme hattına bağlanmış aletleri hiçbir zaman parmağınız saltır üzerinde taşımayın. Hava besleme hattına bağlama işlemini sırasında aletlerin kapalı olduğundan emin olun.
- 15. Daima dikkatli olun**
Kendinizi işinize verin. İşinizde makul biçimde ilerleyin. Konsantrasyonunuz bozılırsa aletlerinizi kullanmayın.
- 16. Aletinizin hasarlı olup olmadığını kontrol edin**
Aletinizi kullanmadan önce, koruyucu donanımları veya hafif hasarlı parçalarını kusura uz ve usulüne uygun işlev görüp görmediklerini kontrol edin. Hareketli parçaların işlevlerini tam olarak yerine getirip getirmediğinizi, sıkışıp sıkışmadıklarını veya parçaların hasarlı olup olmadıklarını kontrol edin. Butin parçalar doğru olarak monte edilmiş olmalı ve aletin kusura uz biçimde çalışması için gerekli bütün koşulları yerine getirmelidir.
Kullanma kılavuzlarında başka türlü belirtilmişse, hasar gören koruyucu donanımlar ve parçalar usulüne uygun olarak bir müşteri hizmeti atölyesinde onarılmalı veya değiştirilmelidir. Hasar gören saltatlar bir müşteri hizmeti atölyesinde yenilenmelidir. Saltatları açmak/kapama yapmayan aletleri kullanmayın.
- 17. Dikkati!**
Kendi güvenliğiniz için sadece kullanma kılavuzunda belirtilen aksesuarı ve uçları kullanın. Kullanma kılavuzu veya katalogta belirtilen aksesuar ve uçlardan başkasını kullanmak sizin için tehlikeli olabilir.
- 18. Onarımlar sadece uzmanına yaptırın**
Bu havalı alet, kendisiyle ilgili güvenlik hükümlerine uygundur. Onarımlar sadece bir uzman tarafından yapılmalıdır, aksi takdirde kullanıcı için kaza tehlikesi ortaya çıkabilir.

Bu güvenlik talimatını iyi biçimde saklayın.

