



48619696
Edition 1
July 2012

Insight Control Software (ICS)

User Manual



Save These Instructions

IR Ingersoll Rand®

Table of Contents

Section 1 – Introduction - 1

1.1 Summary	1
1.2 Process Communication Module (IC-PCM)	1
1.2.1 IC-PCM 1:1	1
1.2.2 IC-PCM 10:1	1
1.2.3 Rotary Switch Settings.....	1
1.2.4 Dip Switch Settings.....	1
1.2.5 LED Indicators	2

Section 2 – Installation - 3

2.1 Mounting.....	3
2.2 Electrical Connection	3
2.3 Attaching Peripheral I/O Devices.....	4
2.3.1 Activating an Input & Receiving an Output	5
2.4 Setting up Network Connections for IC-PCM.....	6
2.4.1 Ethernet Connection	6
2.4.2 Configure IC-PCM using serial terminal.....	6
2.4.3 Assigning a Static IP address to the PC Host.....	10
2.4.4 Assigning a Static IP address to the IC-PCM.....	11
2.4.5 Assigning a Dynamic IP address to the PC Host.....	11
2.4.6 Assigning a Dynamic IP address to the IC-PCM.....	11

Section 3 – Programming a Tool - 12

3.1 Tool Setup	12
3.1.1 Tightening Configuration.....	12
3.1.2 General Setup Screen.....	15
3.1.2.1 Tool Setup.....	16
3.1.2.2 Wireless Setup.....	16
3.1.2.3 Password Settings	16
3.2 IC-PCM 1:1 General Setup.....	17
3.2.1 Version Information	17
3.2.2 General Settings.....	17
3.2.2.1 Tightening Control Settings	17
3.2.2.2 IO (Input/Output) Settings	18
3.2.2.3 Socket Tray and Configuration Switch Connection and Setup using IC-PCM 1:1	20
3.2.2.4 Light Box Connection and Setup	21
3.2.2.5 Date Time Settings	22
3.2.3 Protocol Settings.....	22
3.2.3.1 PCM Serial Port Settings.....	22
3.2.3.2 Barcode/VIN Settings	23
3.2.3.3 Barcode Connection and Setup using IC-PCM 1:1.....	24
3.2.3.4 Serial EOR Settings	25
3.2.3.4 Ethernet EOR Settings Serial EOR Settings:.....	26
3.2.3.5 Ethernet EOR Setup	28
3.2.3.6 PFCS Settings	30
3.2.3.7 Communication via Serial:.....	30
3.2.3.8 Communication via Ethernet:	30
3.2.3.9 PLUS Settings	31
3.2.3.10 XML Settings.....	33
3.2.3.11 XML setup using IC-PCM 1:1	33
3.2.3.12 Open Protocol Settings	34
3.2.3.13 Open Protocol Setup.....	34
3.2.3.14 Label Printing Settings	34
3.2.3.15 Printer Connections and Setup for IC-PCM 1:1	35

3.2.4	FieldBus Settings.....	35
3.2.4.1	ProfiBus Settings.....	35
3.2.4.2	InterBus Settings.....	36
3.2.4.3	Devicenet Settings.....	36
3.2.4.4	Modbus RTU Settings.....	37
3.2.4.5	Modbus TCP/IP/Ethernet IP Settings.....	38
3.3	Parameter Assignment.....	38
3.4	Wireless Tool Settings.....	39
3.4.1	IC-PCM Settings.....	40
3.4.1.1	Ethernet Settings.....	40
3.4.2	Radio Settings.....	41
3.4.3	SNTP Settings.....	41
3.4.4	Channel Hopping Settings.....	41
3.4.4.1	Secondary Channel Settings.....	41
3.4.4.2	Selectable Radio Channels.....	41
3.4.4.3	Mapped Tool Settings.....	41
3.4.4.4	Local Settings.....	41
3.5	Download Software.....	42
3.5.1	Download firmware Procedure for the Tool Connected to USB.....	42
3.5.1.1	MCE Firmware.....	42
3.5.1.2	Display Firmware.....	45
3.5.1.3	Radio Firmware.....	47
3.5.2	Download firmware procedure for a IC-PCM on the Network.....	50
3.5.2.1	RISC Firmware.....	50
3.5.2.2	Radio Firmware.....	52
3.5.2.3	Clear Data.....	53
3.6	Reboot.....	54
3.6.1	Reboot IC-PCM.....	54
3.6.2	Reboot Radio Modules.....	55
3.7	PCM Wireless Energy Detector.....	55

Section 4 – Monitoring Cycle log and Event Log of IC-PCM 1:1/Tool - 56

4.1	Run Main Cycle Log.....	56
4.1.1	Run Main View Tab.....	56
4.1.2	View Cycle Log Tab.....	57
4.1.2.2	Data retrieved from the Archived Database.....	60
4.2	Run Main View All.....	60
4.3	IC-PCM 1:1/ Tool Event Log.....	61
4.3.1	IC-PCM 1:1 Event Log.....	61
4.3.2	Tool Event Log.....	63
4.4	Status/View Network.....	66
4.4.1	IC-PCM 1:1.....	66
4.4.2	IC-PCM 10:1.....	66
4.4.3	USB Direct Tool Connection.....	66
4.5	Create Report.....	67
4.5.1	Tool Report.....	67
4.5.2	VIN Report.....	67
4.5.3	Report Generator.....	68

Section 5 – Archiving Data - 69

5.1	Archival Settings Screen.....	69
-----	-------------------------------	----

Section 6 – Quality Control - 70

6.1 Statistics	70
6.1.1 Statistical Data Saved/Retrieved from Local Database	71

Section 7 – System Diagnostics - 72

7.1 Tool Test.....	72
7.2 Tool Status.....	73
7.3 Keypad, LED and Audio Diagnostics.....	74
7.3.1 Keypad Status	74
7.3.2 LED Test	75
7.3.3 Audio Diagnostics	75
7.4 Tool Calibration	75
7.5 PM Alarms	76
7.6 System Diagnostics – View Inputs	78
7.7 System Diagnostics – View/Set Output	78
7.7.1 View Outputs Mode (Normal Mode)	78
7.7.2 Set Outputs Mode (Diagnostic Mode)	79
7.8 Direct Controller Discovery.....	79

Section 8 – Wireless Diagnostics - 80

8.1 Wireless statistics of USB Connected Tool	80
8.2 Wireless Statistics of the IC-PCM	80

Section 9 – General Screen Layout - 81

9.1 ICS Screen Components.....	81
9.1.1 Title Bar.....	81
9.1.2 Selection of Family Type.....	81
9.1.3 Menu Bar.....	82
9.1.3.1 File Menu	82
9.1.3.2 Run Menu	82
9.1.3.3 Setup Menu	83
9.1.3.4 Status Menu.....	83
9.1.3.5 Statistics Menu	83
9.1.3.6 Diagnostic Menu.....	84
9.1.3.7 ICS Menu.....	84
9.1.3.8 Data Source Menu.....	85
9.1.3.9 View Menu	85
9.1.3.10 Window Menu	85
9.1.3.11 Help Menu.....	85
9.1.4 Main Tool Bar	86
9.1.5 Communication Tool Bar.....	86
9.1.6 Database Tool Bar	86
9.1.7 Work Space	87
9.1.8 Graphics Screens.....	87
9.1.9 Status and Progress Bar	87
9.1.10 Icons	87

Contact Information - 88

Section 1 – Introduction

1.1 Summary

ICS software is designed to provide a programming interface and archiving functionality to extend the functionality of the controllers and QX series tools. Each version of ICS is designed to satisfy a specific customer environment. Unless otherwise noted, the controllers have all functionality within their operating software. Functionality is restricted via the version of ICS software used to interface with the controller or tool. Once a controller has been programmed, ICS can be disconnected and the controller will run independently.

Wireless tools that can communicate with the IC-PCM are designated as QXX. Non-wireless tool that communicate with ICS directly through USB are designated as QXC.

This document will only detail the scope of functionality for the ICS software products and will not detail usage of any of the IC family of controllers, tools or the interface required to communicate.

1.2 Process Communication Module (IC-PCM)

The IC-PCM's (Process Communication Module) are Fastening Systems which can wirelessly communicate to QX tool and can be programmed to send commands to control the way tool behaves. Programming functions for both units (IC-PCM 1:1 and 10:1) are done via ICS software. Tool and the IC-PCM communicates to each other wirelessly. IC-PCM devices can be configured to work in following modes.

1.2.1 IC-PCM 1:1

In this mode the IC-PCM is capable of communicating to only one QX tool. This mode offers following functionalities in addition to the communication with ICS

1. Protocols (PFCS, PLUS, XML, Ford Open Protocol, Label Printing, Ethernet EOR, Serial EOR etc.)
2. Field bus support
3. Smart socket
4. Programmable I/O
5. Config Selection

1.2.2 IC-PCM 10:1

In this mode, the IC-PCM is capable of communicating to maximum of 10 QX tools. In this mode, the IC-PCM acts as a bridge to relay messages between tools and ICS.

1.2.3 Rotary Switch Settings

If the rotary switches are set to "00", then the device will be in IC-PCM 1:1 mode. If the rotary switches are set to "01", then the device will be in IC-PCM 10:1 mode.

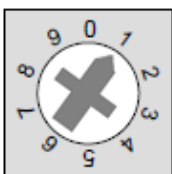
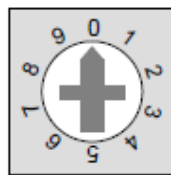
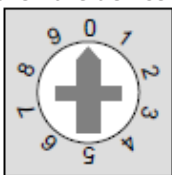

IC-PCM 1:1

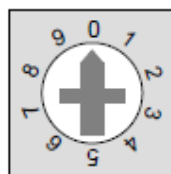

IC-PCM 10:1

1.2.4 Dip Switch Settings

With the switch number 2 'ON', serial debug information will be sent out to serial port of the IC-PCM at the baud rate 38400.

NOTE: If serial debug switch is ON, all Serial Protocol (Serial Barcode, Serial EOR, PLUS, etc.) functionality will be in disabled state.

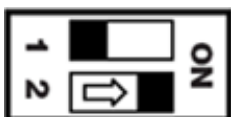

1.2.5 LED Indicators

Power Led	When the IC-PCM is powered on then this LED will be ON.
System Ready Led	This LED shall turn ON when the IC-PCM is fully booted and ready to communicate.
Wireless Activity	This LED shall Turn ON whenever there is a wireless transaction between the IC-PCM and a tool.
Ethernet Activity	This LED will Turn ON whenever Ethernet cable is connect the Port.

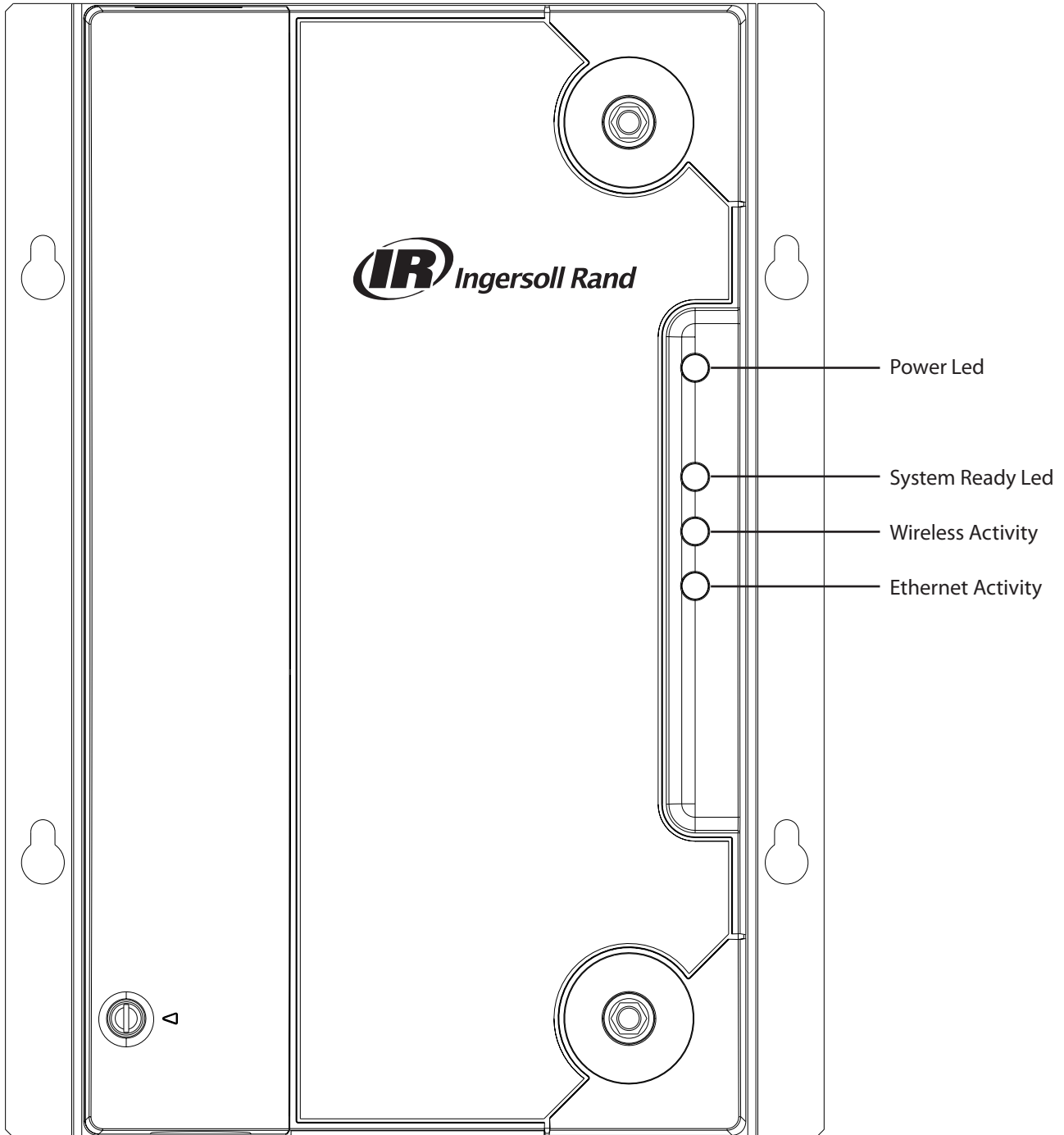

Section 2 – Installation

This section provides information on how to install, setup, program, operate, and troubleshoot IC-PCM. The figure below shows the major elements of the IC-PCM.

2.1 Mounting

IC-PCM should be mounted on a suitable rigid surface near the assembly area using the mounting brackets on the back of the enclosure. See the drawings below for dimensions, information on bracket hole spacing. Make sure the mounting is stable, secure within range. The IC-PCM enclosure is rated for ingress protection of IP52 mounted in an upright and vertical position as shown.

NOTE: If environmental greater than IPX0 is required, additional protection will be required for the external power supplies.

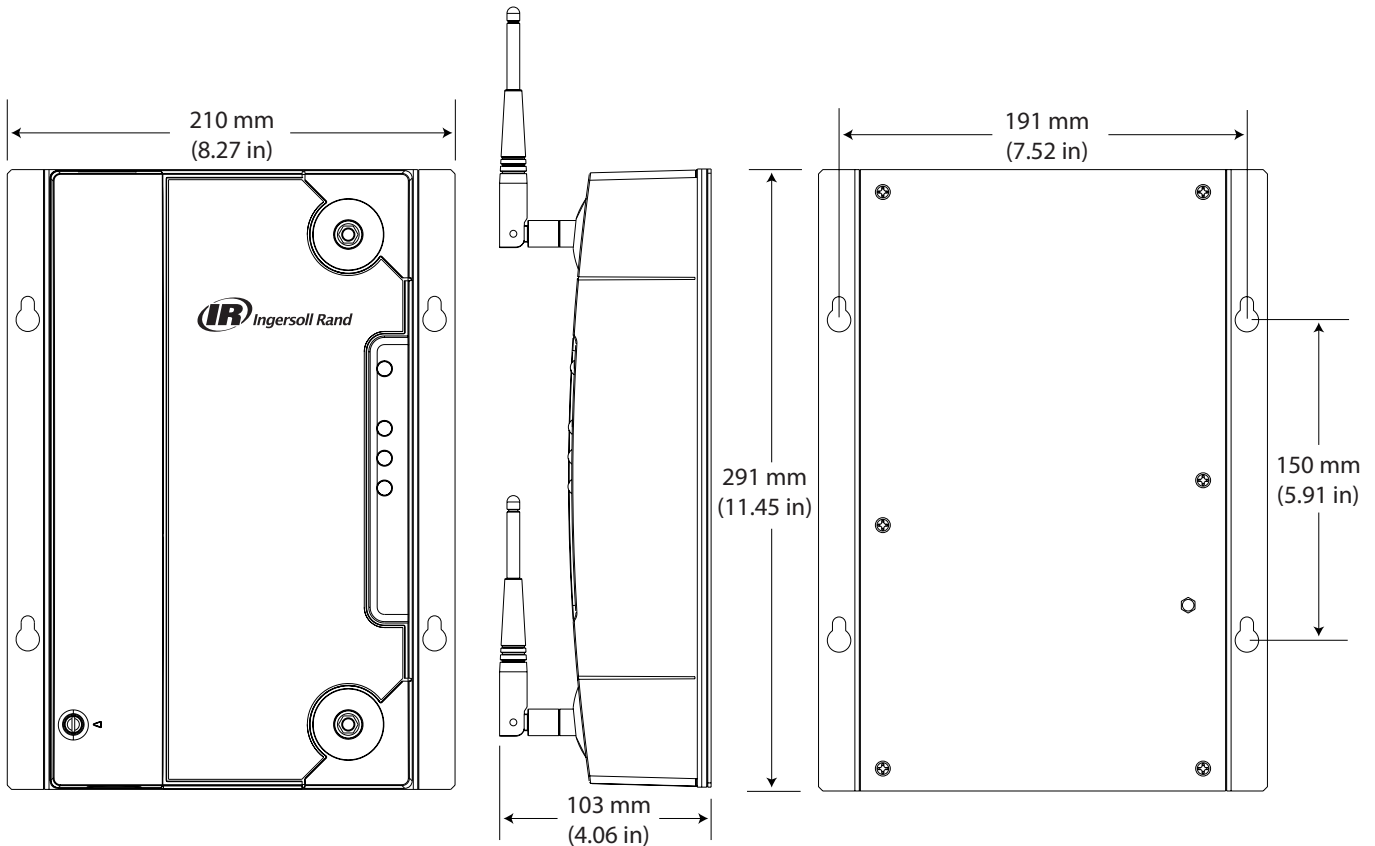

2.2 Electrical Connection

IC-PCM is available with various power cord options. Review the electrical circuit information on the label (on the Bottom panel) and in the safety information manual. Verify that your electrical circuit meets the power requirements and circuit breaker ratings. Plug the AC power cord into an appropriate receptacle.



It is the user's responsibility to ensure that the IC-PCM is installed and wired by a qualified electrician.

2.3 Attaching Peripheral I/O Devices

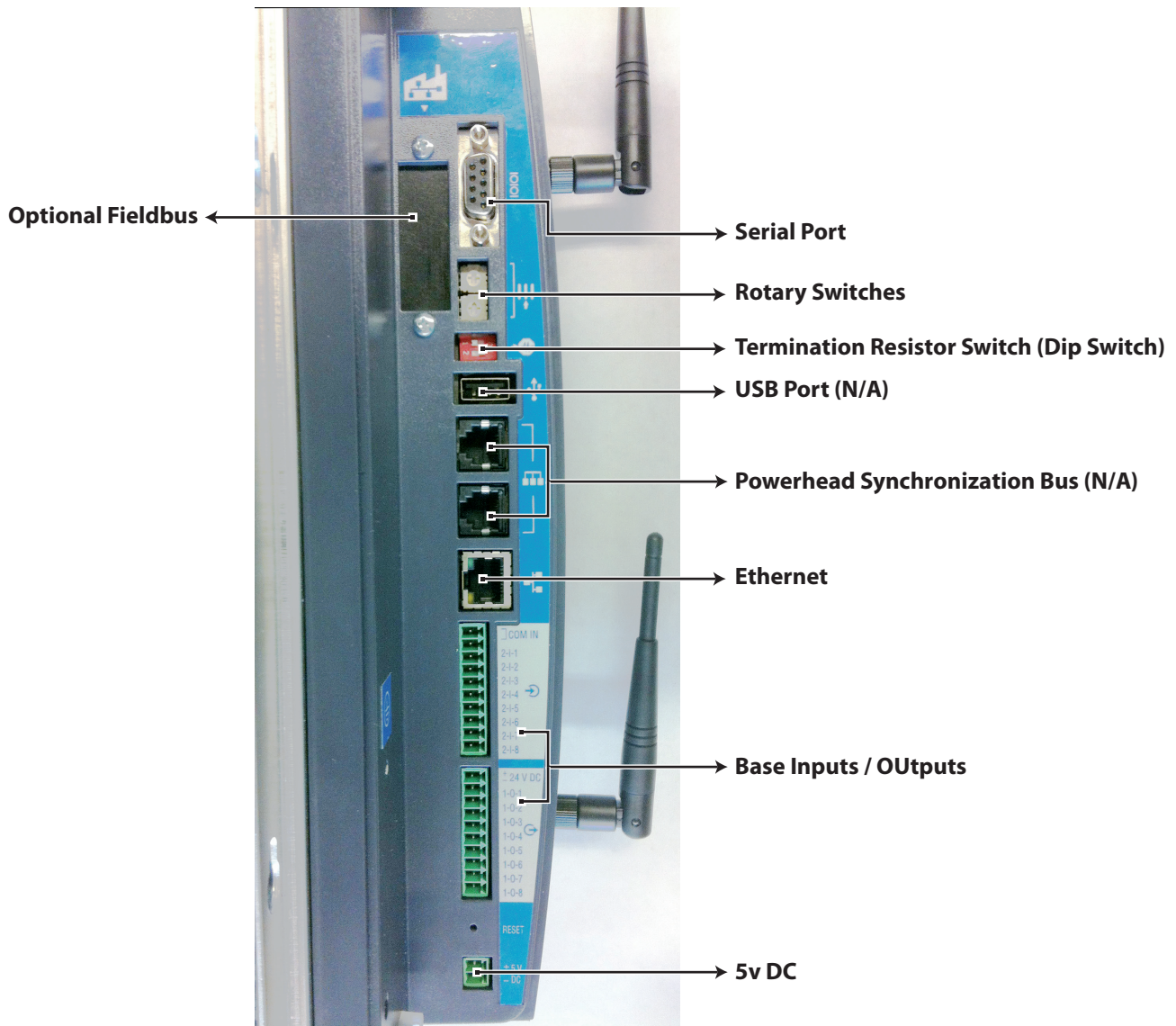

NOTE: The Power-head synchronization bus and USB port are not in use.

2.3.1 Activating an Input & Receiving an Output

All input signals operate at 24VDC. The Return for the 24V signal must be connected to COM IN for each input bank.

All output signals operate at 24VDC. The 24V signal and its return must be connected to the terminal blocks labeled +/- 24VDC EXT on each output connector bank. The output signals will be switched back from the appropriate output signal (ACCEPT, REJECT, HIGH TORQUE, etc...).

Example: PLC Connection and Setup

All connections to a PLC are made via the IC-PCM 1:1 I/O terminal blocks, except data collection. Data collection is done via the serial Fieldbus and/or Ethernet ports. For data collection, follow the procedures for setup using the serial or Ethernet port. Through the terminal blocks, a PLC can send inputs to the IC-PCM 1:1 and receive outputs from the IC-PCM 1:1. It is important to always use a shielded cable (to avoid external noise and interference) for all PLC signals to IC-PCM 1:1 and the shield should be terminated at the IC-PCM 1:1 end.

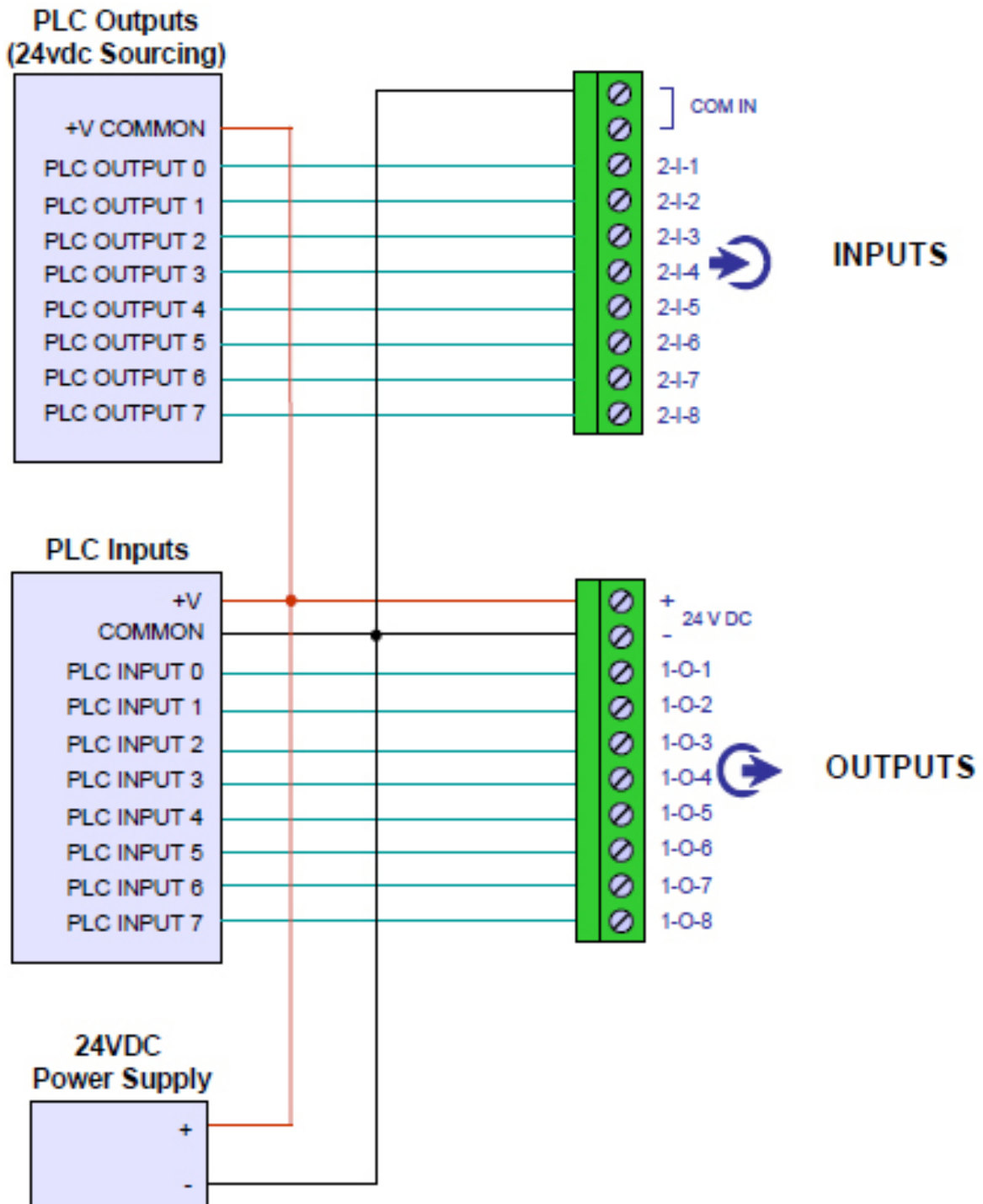

2.4 Setting up Network Connections for IC-PCM

2.4.1 Ethernet Connection

An Ethernet port can be found on the connector panel of the IC-PCM unit. ICS can communicate with IC-PCM only using Ethernet connection.

To change Ethernet settings of the IC-PCM, go to the Wireless Settings screen. The settings for IP Address, Subnet Mask, and Gateway can be viewed/modified. User has an option to Enable/Disable Dynamic Host Communications Protocol (DHCP). When DHCP is turned ON, it allows the network server to set the IP addresses for the IC-PCM.

2.4.2 Configure IC-PCM using serial terminal

IC-PCM network settings can be configured using and terminal emulator software (Hyper Terminal, Clear Terminal etc.). Following are the settings that can be changed.

1. IP Address.
2. Subnet Mask.
3. DHCP.
4. Default Gateway.

If Hyper Terminal software is not available in the computer then Clear Terminal software can be downloaded from following location.

<http://www.clearconnex.com/content/clearterminal>

Follow the steps below the configure IC-PCM.

1. Push dip switch 2 to ON Position to place into debug mode as shown below.



2. Connect serial port cable (DB 9) to the computer and IC-PCM.

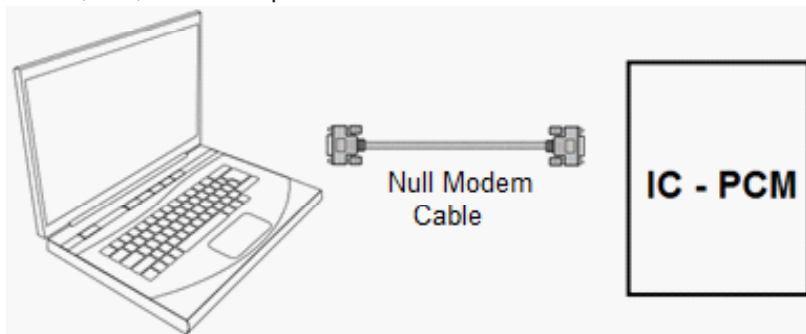

3. Open terminal emulator software.

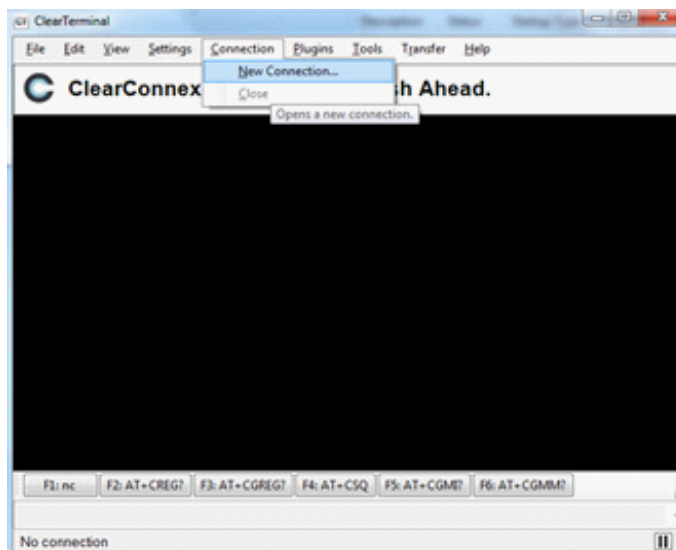

4. Select the connected COM Port.
5. Select following parameter for COM Port.
 - a. Baud Rate : 38400
 - b. Data bits : 8
 - c. Stop bits : 1
 - d. Parity : None
 - e. Flow Control : None

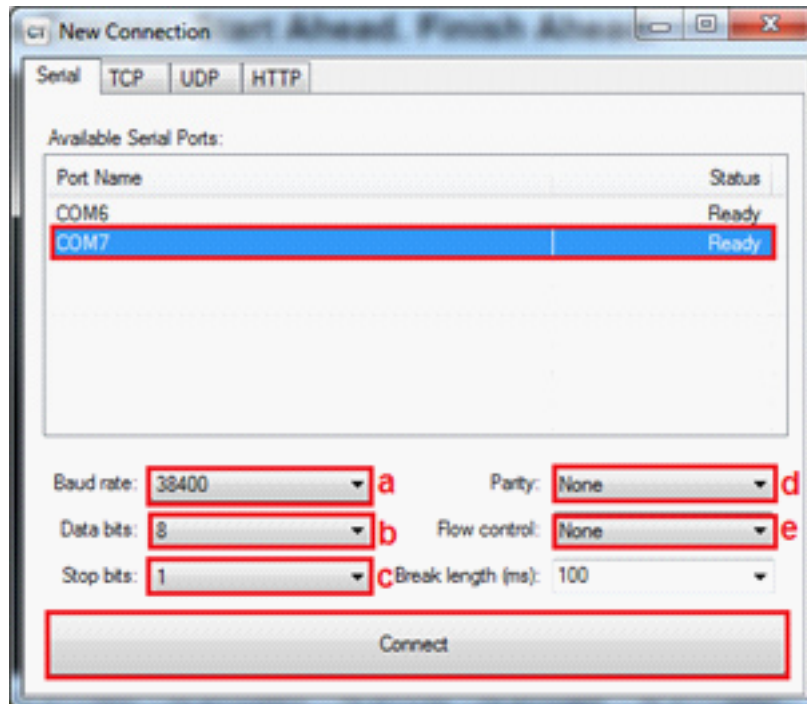

6. Click on Connect Button. Following screen will appear with some data.

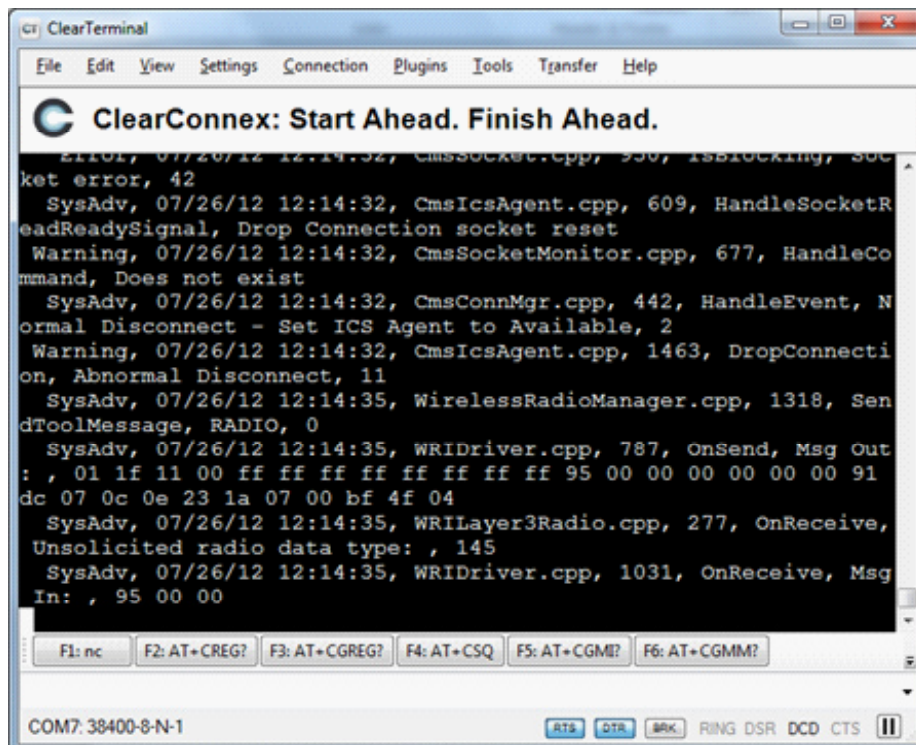

7. Type 'nc' and press 'Enter' key to view current settings.

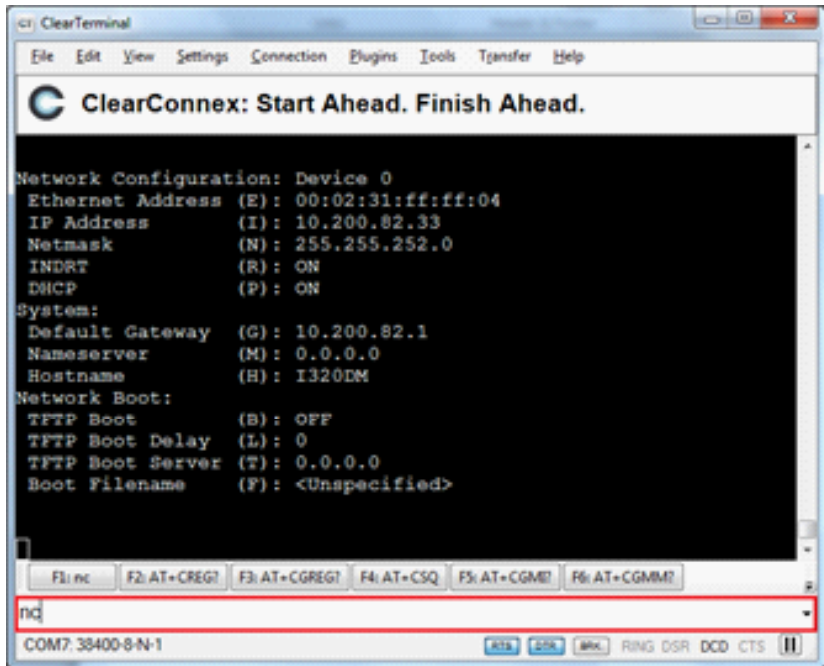

8. Following is the format to change the settings

nc <code> <new value> ↵

Following are the codes that can be used to change the settings

#	Code	Value	Description
1	i	xxx.xxx.xxx.xxx	New IP address will be assigned.
2	n	xxx.xxx.xxx.xxx	New sub net mask will be assigned.
3	p	on/off	DHCP will be enabled or disabled.
4	g	xxx.xxx.xxx.xxx	New gateway address will be assigned.

Note:

- Make sure that Ethernet Address is not changed, if changed it should be unique in the network else the IC-PCM is not discovered in network. To change Ethernet Address (MAC Address) enter nc e xx:xx:xx:xx:xx:xx where xx is number between 00 to FF in hexadecimal.
- To change the IP address DHCP should be disabled (OFF) else the IP address is taken from DHCP server.
- Default Gateway value should be same as system where ICS is running.

9. Send save command to commit the changes and restart after 30 seconds. Command to save the settings is 'nc s' ↵.

Follow the procedure to assign static IP.

- Type 'nc p off' to disable the DHCP.

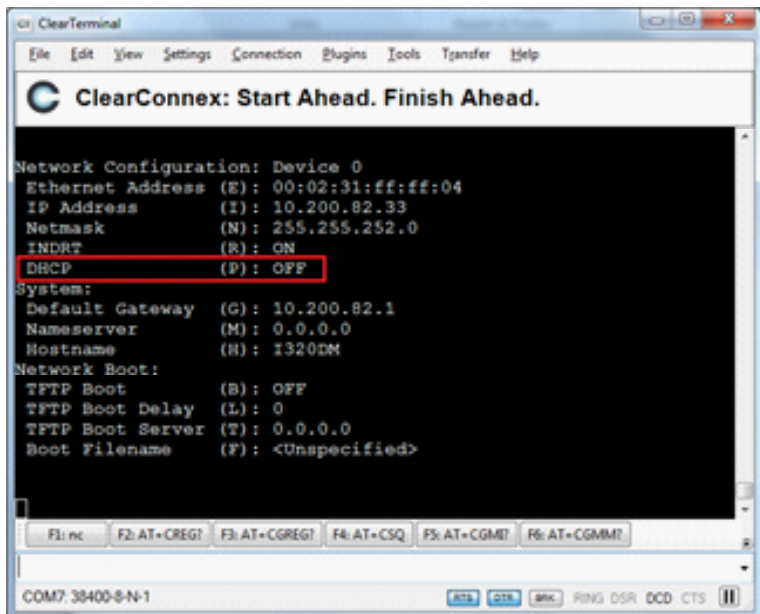

- Set IP address to 192.168.1.1 'nc i 192.168.1.2'

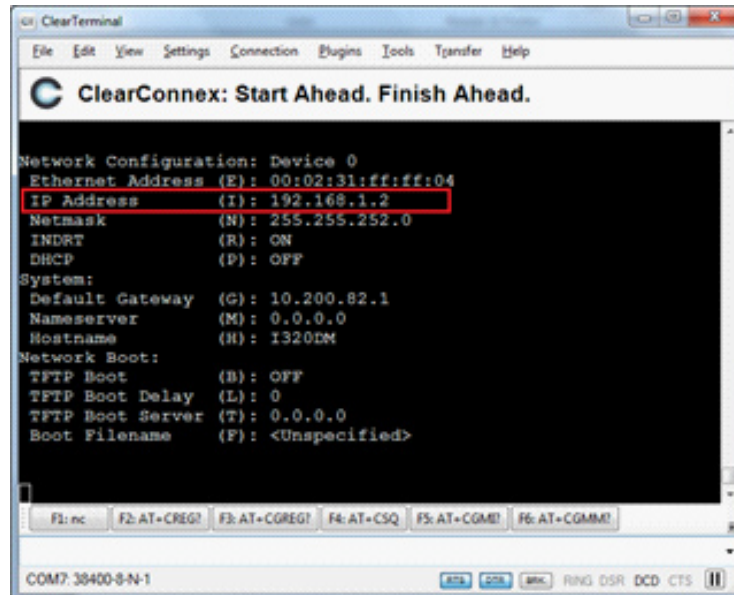

- Set default gateway to 'nc g 192.168.1.1'

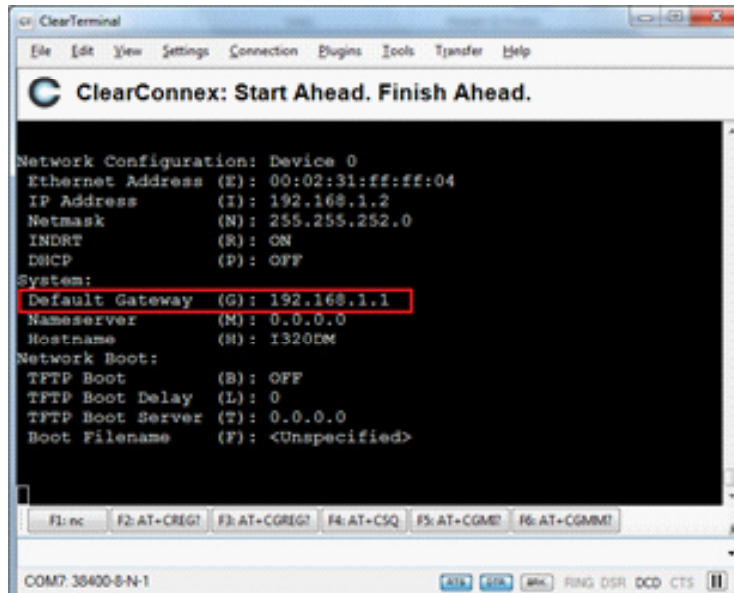

- Type 'nc s' to save any changes made.

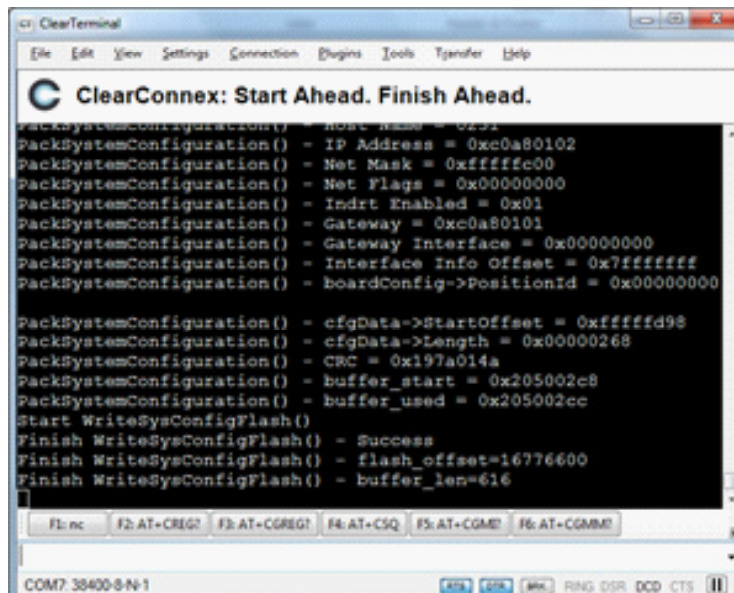

- Reboot after 30 seconds for the changes to take place.
- Once rebooted verify the settings using nc command. (Type nc ↵)

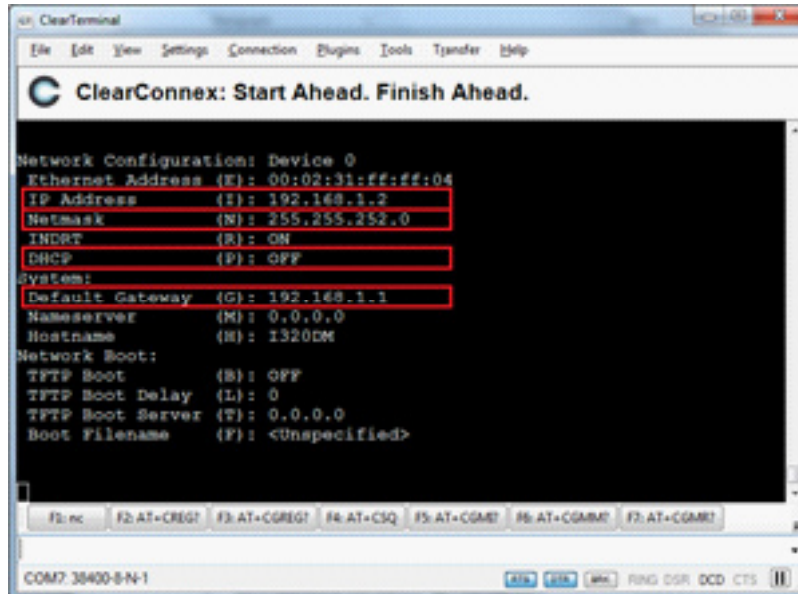

Note: Enable DHCP to acquire IP from DHCP server.

2.4.3 Assigning a Static IP address to the PC Host

When using a one-to-one connection between the IC-PCM and a PC, locate the TCP/IP properties in the control panel under the local network connections. Select 'Use the following IP address' and configure as below which requires a one-to-one connection a crossover cable needs to be used. If connecting to an existing local network, use values that are compatible with the network using a standard Ethernet cable.

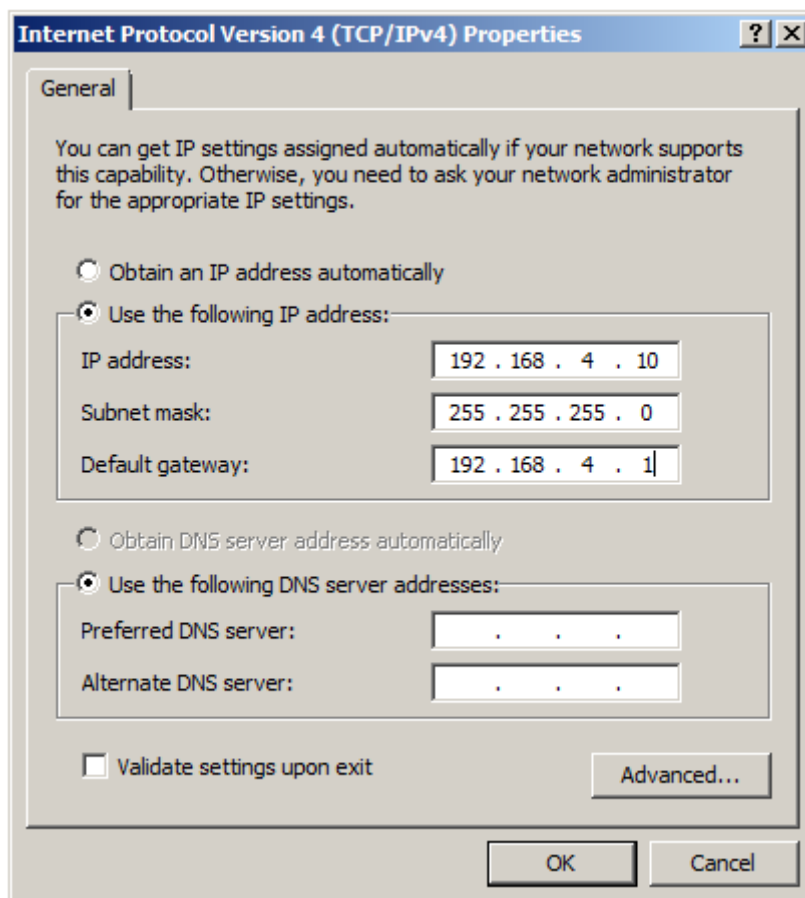

2.4.4 Assigning a Static IP address to the IC-PCM

- Turn OFF the IC-PCM and set the RED DIP switch to ON for switch 2.
- Connect serial null-modem cable from IC-PCM to the PC.
- Launch HyperTerminal or other terminal emulation software such as Clear Terminal.
- Reboot the IC-PCM. Type 'NC' in the serial terminal to start serial activity.
- Type 'NC P off' to disable the DHCP and then Type 'NC S' to save the settings.
- Type 'NC I xxx.xxx.xxx.xxx' using serial terminal where xxx.xxx.xxx.xxx is the desired IP address.
- Set subnet if different Default Gateway should take on the form xxx.xxx.xxx.1. Where the x values match the IP Address. If using crossover cable, use IP :192.168.4.4.
- Type 'NC S' to save any changes made.
- Reboot the IC-PCM after 30 seconds for the changes to take place.

2.4.5 Assigning a Dynamic IP address to the PC Host

Locate the TCP/IP properties in the control panel under the local network connections. Select 'Obtain an IP address automatically' as below.

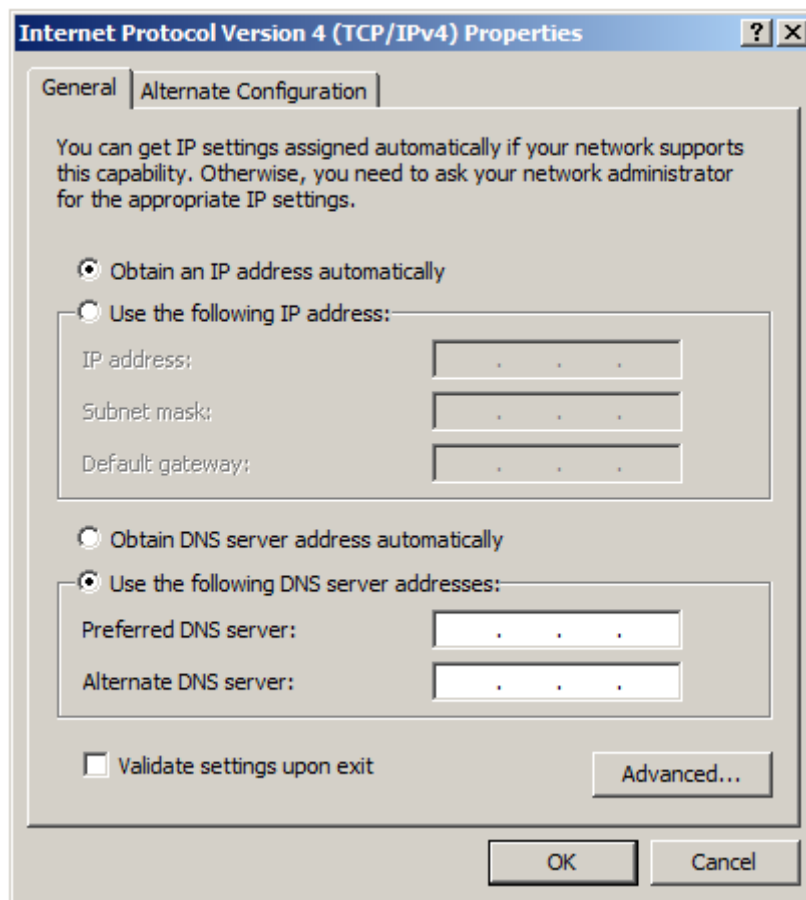

2.4.6 Assigning a Dynamic IP address to the IC-PCM

Using the 'NC' command, configure as follows. Making sure that the IP Address, Gateway address and Net Mask match the network structure.

- Type 'NC P ON' and then type 'NC S' to save the settings.
- Type 'NC N xxx.xxx.xxx.xxx' and then type 'NC S' to save the new Subnet address. The Subnet address should match the Subnet address of the host PC.
- Type 'NC G xxx.xxx.xxx.1' and then type 'NC S' to save the new Gateway address. The xxx.xxx.xxx should match the IP Address.
- Reboot the IC-PCM after 30 seconds for the changes to take place.

Section 3 – Programming a Tool

Use Setup Menu from ICS Main Menu Bar for programming a tool. This section explains how to program a tool.

3.1 Tool Setup

The Tool setup screen has two tabs: Tightening Configuration and General Setup, by default the Tightening Configuration tab is opened.

3.1.1 Tightening Configuration

The Tightening Configuration screen is used to program the QX series tool. Torque / Angle / Prevailing Torque strategies can be setup from this screen.

The Configuration sets that are created using this screen can be sent to a tool (in Network mode) or they can be stored locally.

Configuration sets can also be created and stored in the Local Database Mode. The locally stored Configuration Sets can then be sent to a tool using the Parameter Assignment screen.

The user can also view the archived configuration data stored in the archived database.

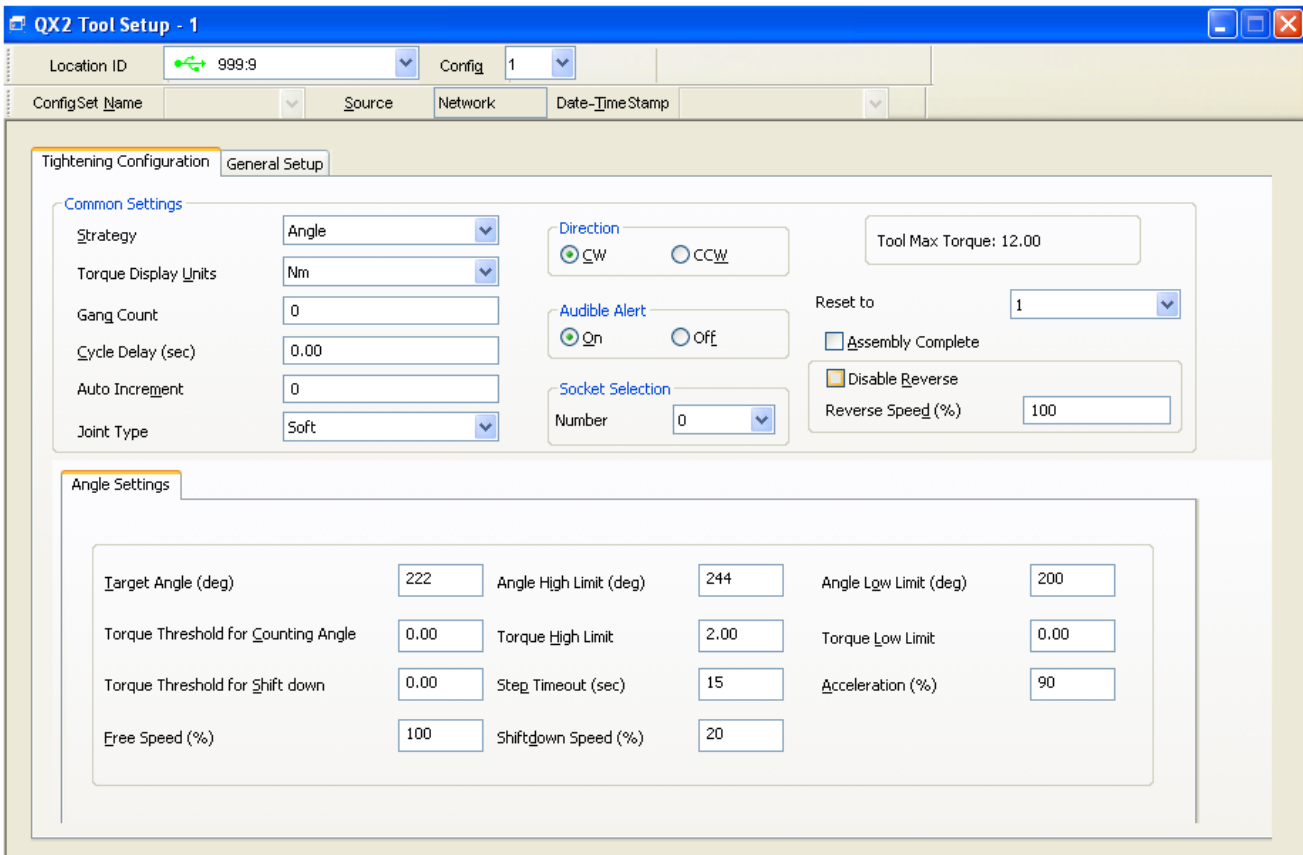

Location ID Drop box	Location ID is used as a unique identifier for each tool on the network.
Config Drop box	Configuration drop box allows selection of all available configurations, 1 through 8, for Programming and/or Viewing the Tightening settings.
Strategy	Allows selection of valid fastening strategies: Torque control, Angle control and Prevailing Torque. Torque control is the default Strategy.
Torque Display Units	Allows selection of all available Torque Units: Nm, Ft-lbs, In-lbs, and d-Nm. All the Torque values will be displayed with the selected units. Nm is the default unit.
Gang Count	Gang Count can be used if the assembly requires multiple bolts to be fastened in a group. The default value is 0 and the range is between 0 – 99.
Cycle Delay (Sec)	Time interval between each fastening cycle. The tool will be in a locked state until the time interval elapses. The default value is 0 and the range is 0 – 10 seconds.

Auto increment	Auto increment can be used to move through a specific sequence of fastening configurations. After a Pass cycle or gang complete if gang count is set greater than 1, the tool will automatically increment to the Configuration programmed in this field. The default value is 0 and valid values are Config 1 through 8.
Joint Type	Allows selection of Joint Type. There are two options – Hard and Soft. Hard will be selected by default.
Direction	Sets the tool tightening direction to CW (Clockwise) or CCW (Counter-clockwise). CW is selected by default.
Audible Alert	Turns 'ON' or 'OFF' the tool buzzer. The Audible Alarm will sound for any Failed cycle, when this feature is turned 'ON'.
Socket Selection	Smart socket is intended as an interlock for the user. On selection of the configuration, the tool will be disabled and an LED will glow in socket tray, indicating which socket the user must select (the one programmed in this field). The tool will only be enabled when all other sockets are in place and the required socket removed from the tray. The default value is 0 and valid values are 1 through 8. This selection is only pertinent if the Smart Socket feature is enabled in the tool setup.
Tool Max Torque	The maximum allowable Torque for the connected tool. This Field is not applicable in the Local Database Mode. This field is read-only.
Reset To	The Reset to parameter is used to indicate which configuration the tool should be set to after the Configuration Reset Input is received by the IC-PCM 1:1.
Assembly Complete	When checked, the tool will send an Assembly Complete Event to the IC-PCM 1:1 which will then turn on a programmed External Output.
Disable Reverse	When checked, the tool will not run in the Reverse direction.
Reverse Speed (%)	The percent of Max Speed at which the tool will run in the reverse direction. The default value is 100%.

There are three strategies as described below:

Torque Settings	
Target Torque	Target Torque is the value of selected configuration. Must be \leq Tool Max Torque.
Torque High Limit	The maximum acceptable torque value for a fastening. Must be \geq the Target Torque and cannot exceed 120% of the tool max torque value. Once the Target Torque value is entered, this value will be populated as 120% of the Target.
Torque Low Limit	The minimum acceptable torque value for a fastening. Must be \leq the Target Torque. Once the Target Torque value is entered, this value will be populated as 80% of the Target.
Angle high Limit (deg)	The maximum acceptable angle through which the fastener may turn. Maximum value cannot exceed 32000 degrees, which is the default value.
Angle Low Limit (deg)	The minimum angle through which the fastener must turn. The default value is 0.
Torque Threshold for Count Angle	The torque required to seat the fastener in the joint. This is the torque point at which angle begins to be measured. Must be \leq the Target Torque. Once the Target Torque value is entered, this value will be populated as 50% of the Target.
Torque Threshold for Shiftdown	The Torque point during tightening at which the tool shifts to a lower speed (to improve accuracy). Must be \leq the Target Torque. Once the Target Torque value is entered, this value will be populated as 25% of the Target.
Step Timeout (Sec)	Maximum allowable time for completing the step. The default value is 15 seconds and the range is 1- 65 seconds.
Acceleration (%)	Tool motor acceleration at the start of a tightening. The default value is 90% and the range is 5% to 100%.
Free Speed (%)	Speed at which tool will run before reaching Torque Threshold for Shiftdown. The default value is 100% and the range is 10% to 110%.

Shiftdown Speed (%)	Speed at which tool will run after reaching Torque Threshold for Shiftdown. Must be \leq Free Speed. The default value is 10% and the range is 10% to 100%.
Angle Settings	
Target Angle (deg)	Target Angle value for the selected configuration in degrees.
Angle high Limit (deg)	The maximum acceptable angle through which the fastener may turn. Must be \geq the target and cannot exceed more than 35200 degrees. Once the Target Angle value is entered, this value will be populated as 120% of the Target.
Angle Low Limit (deg)	The minimum angle through which the fastener must turn. Must be \leq the target value. Once the Target Angle value is entered, this value will be populated as 80% of the Target.
Torque High Limit	The maximum acceptable torque value for a fastening. Cannot exceed the Tool Max torque value. The default value is 0.
Torque Low Limit	The minimum acceptable torque value for a fastening. Cannot exceed the Tool Max torque value. The default value is 0.
Torque Threshold for Count Angle	The torque required to seat the fastener in the joint. This is the torque point at which angle begins to be measured. Must be \leq Torque High Limit.
Torque Threshold for Shiftdown	The Torque point during the tightening at which the tool shifts to a lower speed (to improve accuracy). Must be \leq Torque High Limit.
Step Timeout (Sec)	Maximum allowable time for completing the step. The default value is 15 seconds and the range is 1- 65 seconds.
Acceleration (%)	Tool motor acceleration at the start of a tightening. The default value is 90% and the range is 5% to 100%.
Free Speed (%)	Speed at which tool will run before reaching Torque Threshold for Shiftdown. The default value is 100% and the range is 10% to 110%.
Shiftdown Speed (%)	Speed at which tool will run after reaching Torque Threshold for Shiftdown. Must be \leq Free Speed. The default value is 20% and the range is 10% to 110%.
Prevailing Torque Settings	
Cut In Zone Settings	
Target Cut-In Angle (deg)	Target Angle value for the Cut-In Zone step in degrees.
Torque High Limit	Maximum torque that is allowed during the Cut In Zone. If the measured torque is \geq this value the step is halted and a fault declared. Value must be \leq the Tool Max Torque.
Snug Torque	The torque point at which angle begins to be measured. Must be \leq the Torque High Limit.
Prevailing Zone Settings	
Target Prevailing Angle (deg)	Target Angle value for the Prevailing Torque Zone step.
Angle High Limit (deg)	Maximum angle of rotation allowed during the Prevailing Torque Zone. If the measured Angle is \geq this value the step is halted and a fault declared.
Angle Low Limit (deg)	Minimum angle of rotation that must be turned during the Prevailing Torque Zone. When the Prevailing Torque Zone is exited the measured Prevailing Angle is checked to make sure it is greater than this limit. If it is not an Under Angle Fault is indicated.
Torque High Limit	The maximum allowable torque during the Prevailing Torque Zone. If the measured torque equals or exceeds this limit the step is halted and a fault declared.
Torque Low Limit	Minimum torque that should be achieved during the Prevailing Torque Zone. If the cycle is stopped during the Prevailing Torque Zone Step (trigger release or some other failure) and the measured torque value is below the Torque Low Limit, a failure will be indicated (Yellow LED). If Low Torque is the only fault, the tool will continue to the Torque Step.

Common Settings	
Free Speed (%)	Speed at which tool will run during the Cut In and Prevailing Torque Zones. The default value is 80%.
Final Torque Settings	
Same as for a normal Torque Strategy.	

Steps to program a configuration:

1. From the Setup menu, click Tool Setup, ICS opens the Tool Setup window with Tightening Configuration tab enabled.
2. Select the desired tool from the Location ID drop box.
3. Select the desired configuration from the Config drop box.
4. If the configuration is programmed, the data will display on the screen. Make any changes required, and then click the Send button on the toolbar to send the data.
5. If the configuration is not programmed, all the default values will be populated.
Enter all parameters as required and click the Send button on the toolbar to send the data to the tool.
6. To save this Configuration locally click the Save icon on the toolbar. Select 'Yes'. Enter a Config Name when prompted and select 'OK'.

To save a configuration:

1. From the Setup menu, click Tool Setup, ICS opens the Tool Setup window with Tightening Configuration tab enabled.
2. Click the Database Mode button on the toolbar.
3. Program all parameters with desired values.
4. Enter a name for the configuration in the Config Set Name entry box.
5. Choose Save from the File menu to save the configuration into local database.
6. Once saved to the Local Database the user can send the Configuration to the tool using the Parameter Assignment screen.

3.1.2 General Setup Screen

The General Setup tab allows the user to retrieve, edit and send the general settings for the selected tool in Network Mode or retrieve and save settings in the Local Database Mode. Once saved to the Local Database the user can send the saved General Settings to the tool using the Parameter Assignment screen. Once saved to the Local Database the user can send the saved General Settings to the tool using the Parameter Assignment screen.

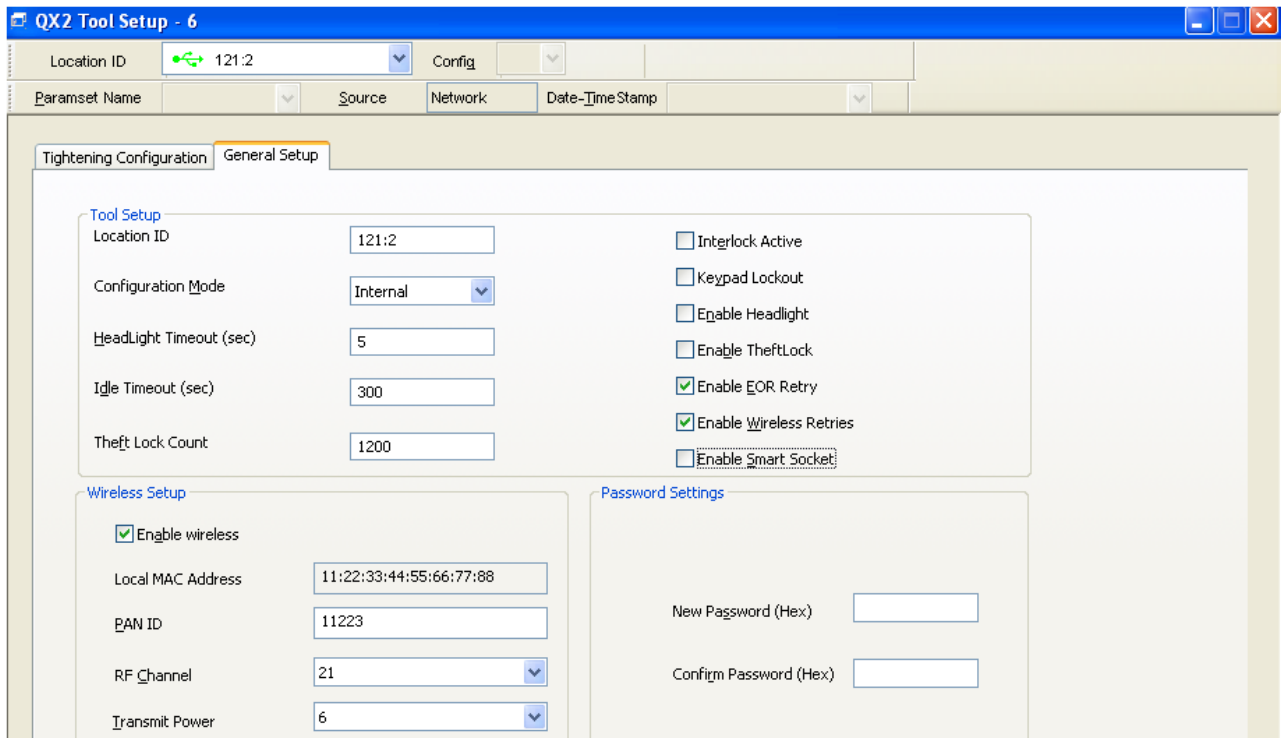

General Setup tab has three sub sections as follows;

3.1.2.1 Tool Setup

Location ID	Used to set a Location ID for a particular tool. The Location ID is used as a unique identifier for each tool on the network. Location ID Number is a four-digit entry that represents a location on the assembly line. Each tool must have a unique Location ID.
Configuration Mode	Sets how Configurations are selected. The options available from the dropdown box for this parameter are Internal, External and Any. Internal: Tightening Configuration number can be selected using tool display only. External: Tightening Configuration number can be selected using external media such as IC-PCM 1:1 or ICS only. Any: Tightening Configuration number can be selected using Internal or External Modes.
Headlight Timeout	If the Headlight is Enabled, it will turn OFF after the specified duration set in the Headlight Timeout field.
Idle Timeout	The tool will switch to 'Sleep Mode' if left the trigger on the tool has not been pressed for the duration specified in this field. This is used to preserved battery life. Using the display keypad or ICS to communicate with the tool will not prevent the tool from entering 'Sleep Mode'.
Theft Lock Count	If Theft Lock is Enabled, once out of range of the PCM, the tool will run cycles until it reaches the specified Theft Lock count. The tool will then become disabled and gives an Error Code F-01 on the display when the trigger is pulled. See section Enable Theft lock for more information.
Interlock Active	When checked, this function disables the tool after Pass cycle, after a Gang Complete, or after the last Configuration in a chain has completed. The tool will stay disabled until a new Configuration is selected.
Keypad Lockout	When checked, the keypad on the tool is locked so that the user is not able to enter the Password screen and change Configuration settings. The user will still have the ability to scroll through the tool settings.
Enable Headlight	When checked, the Tool Headlight is enabled.
Enable Theft Lock	When checked, the Theft Lock feature is enabled. The Theft Lock feature is an anti-theft feature where the user sets a theft lock count. Once out of range of the PCM, the tool will run cycles until it reaches the specified Theft Lock count. The tool will then become disabled and gives an Error Code F-01 on the display when the trigger is pulled. The tool will remain locked until it is within range of the PCM. The counter will then be reset.
Enable EOR Retries	When checked, EOR retries are enabled.
Enable Wireless Retries	When checked, communication retries for the RF Module connected to the tool are enabled.
Enable Smart Socket	When checked, the tool will be locked until the proper socket is selected.

3.1.2.2 Wireless Setup

Wireless parameters of the tool can be set only when tool is connected to USB.

Enable Wireless	Enables wireless functionality of the tool.
Enable Channel Hopping	Disables channel hopping functionality on tool. Channel hopping is enabled via the PCM settings only.
Local MAC Address	Displays the tool MAC address for the connected tool. User cannot modify the MAC address.
PAN ID	16 bit value which is used uniquely to identify one node from the collection of nodes on the physical channel.
RF Channel	Identifier for the radio frequency channel being used. As defined by the 802.15.4 specification.
Transmit Power	Used to control the db level of the radio transmitter

3.1.2.3 Password Settings

The Password Setup module is used to set the password for the connected tool. The password is defined as a four digit numeric value. The Password settings module of the tool can be set only when tool is connected to USB.

3.2 IC-PCM 1:1 General Setup

The IC-PCM 1:1 General Setup screen provides an option to setup the general settings for the selected IC-PCM 1:1 and allows to save the settings to the Local Database.

This screen also allows viewing of archived general settings of the IC-PCM 1:1 by retrieving the information from archived database.

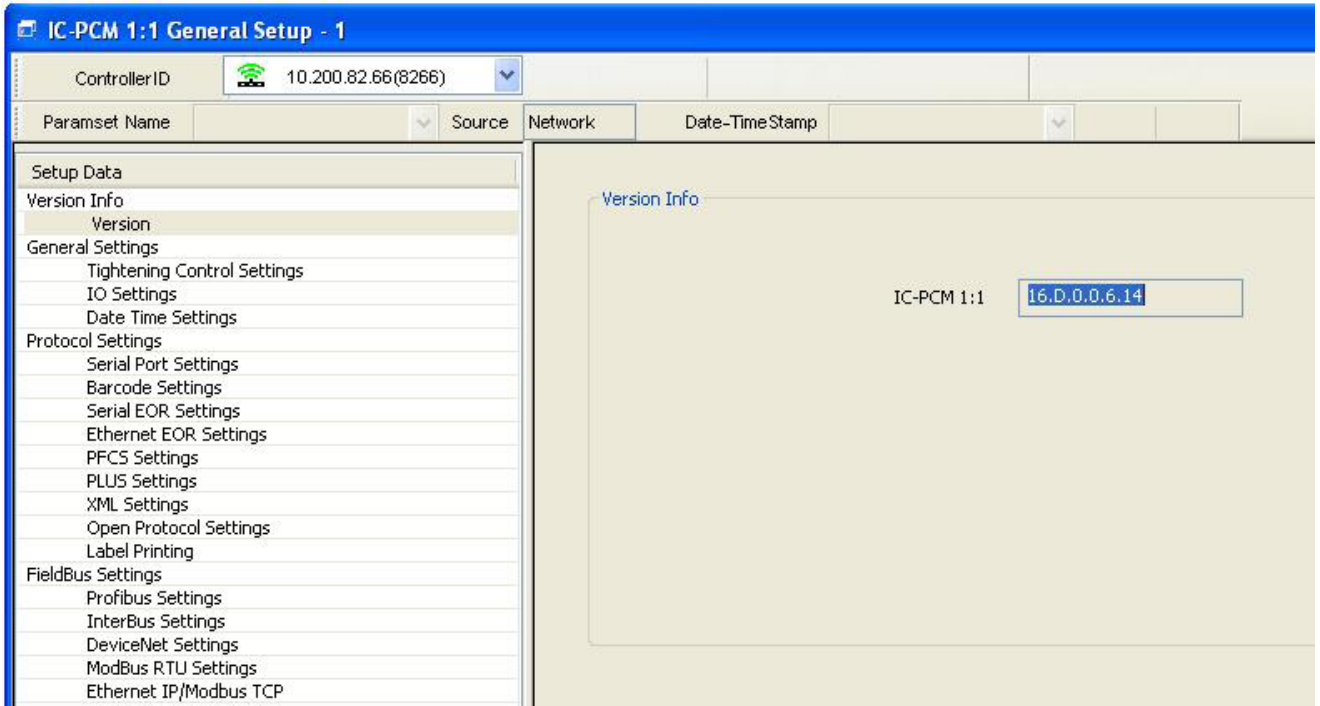

Following are the settings which can be programmed/Viewed for the selected IC-PCM 1:1;

- Version Information
- General Settings
- Protocol Settings
- FieldBus Settings

3.2.1 Version Information

Version information selection displays the currently installed IC-PCM RISC version for the selected IC-PCM 1:1.

3.2.2 General Settings

Following are the settings which can be programmed from General settings tab for the selected IC-PCM 1:1;

- Tightening Control Settings
- IO Settings
- Local Settings
- Date Time Settings

3.2.2.1 Tightening Control Settings

Tightening control settings allows programming the type of "Configuration selection mode", "Remote Tool Enable/Disable Mode" and Enable/Disable option for Smart Socket feature.

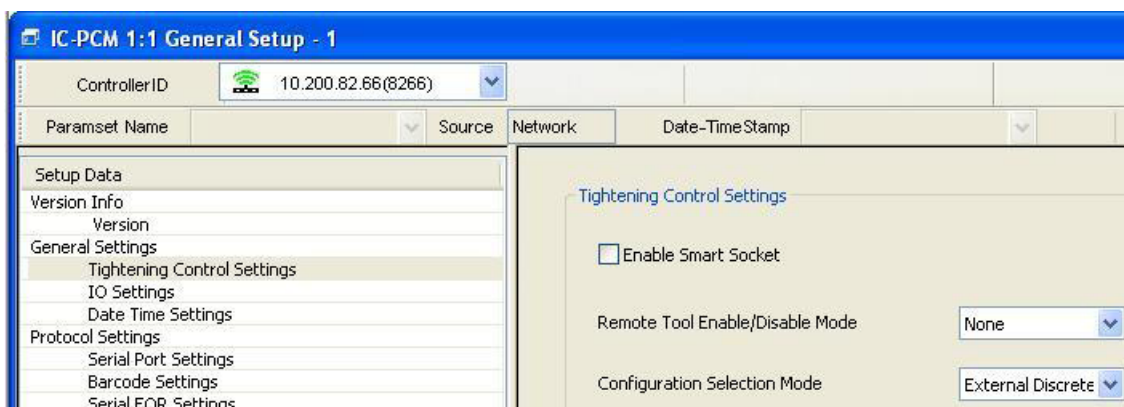

Remote Tool Enable/Disable Mode	<p>This allows the user to enable/disable the tool tightening operation remotely.</p> <p>“1-Line” option: The “Enable” input pin of the IC-PCM 1:1 must be ON in order to start the tightening operation for the tool. To disable the tool,, “Enable” input pin should be OFF.</p> <p>“2-Line” option: The “Disable” input pin of the IC-PCM 1:1 must be ON in order to disable the tool from tightening operation. To enable the “Tightening operation”, the “Disable” input pin should be OFF and “Enable Input pin” bit should be pulsed</p> <p>“None”: sets the tool mapped to the IC-PCM 1:1, always in enabled mode for tightening operation</p>																																				
Configuration Selection Mode	<p>Configuration Selection feature sets the selection method in the IC-PCM 1:1 of the mapped tool.</p> <p>“External Discrete” option: Allows to select the configuration of the mapped tool by activating specific input pin for which configuration number input behaviour is assigned.</p> <p>“External Binary” option allows to select the configuration numbers (1 to 8) for the mapped tool using the combination as shown below Assign Config 1, 2, 3 input behaviours to Input pin 1, 2, 3.</p> <table border="1" data-bbox="323 584 930 925"> <thead> <tr> <th>Config</th> <th>Input 1</th> <th>Input 2</th> <th>Input 3</th> </tr> </thead> <tbody> <tr><td>1</td><td>0</td><td>0</td><td>0</td></tr> <tr><td>2</td><td>1</td><td>0</td><td>0</td></tr> <tr><td>3</td><td>0</td><td>1</td><td>0</td></tr> <tr><td>4</td><td>1</td><td>1</td><td>0</td></tr> <tr><td>5</td><td>0</td><td>0</td><td>1</td></tr> <tr><td>6</td><td>1</td><td>0</td><td>1</td></tr> <tr><td>7</td><td>0</td><td>1</td><td>1</td></tr> <tr><td>8</td><td>1</td><td>1</td><td>1</td></tr> </tbody> </table> <p>“External Ethernet” option in the IC-PCM 1:1 allows selecting the configuration number of the mapped tool based on the configuration selection message which is received on its Ethernet port. IC-PCM 1:1 will always be listed on the Port Number 61000 for configuration selection message.</p> <p>NOTE: This Port number cannot be configured by the user.</p>	Config	Input 1	Input 2	Input 3	1	0	0	0	2	1	0	0	3	0	1	0	4	1	1	0	5	0	0	1	6	1	0	1	7	0	1	1	8	1	1	1
Config	Input 1	Input 2	Input 3																																		
1	0	0	0																																		
2	1	0	0																																		
3	0	1	0																																		
4	1	1	0																																		
5	0	0	1																																		
6	1	0	1																																		
7	0	1	1																																		
8	1	1	1																																		
Enable smart Socket	<p>“Enable Smart Socket” check box enables the smart socket tray selection feature on the IC-PCM 1:1. This function requires that the user remove the assigned socket from the tray in order for the tool to be enabled. The socket is assigned by the configuration settings.</p>																																				



3.2.2.2 IO (Input/Output) Settings

Assign Input

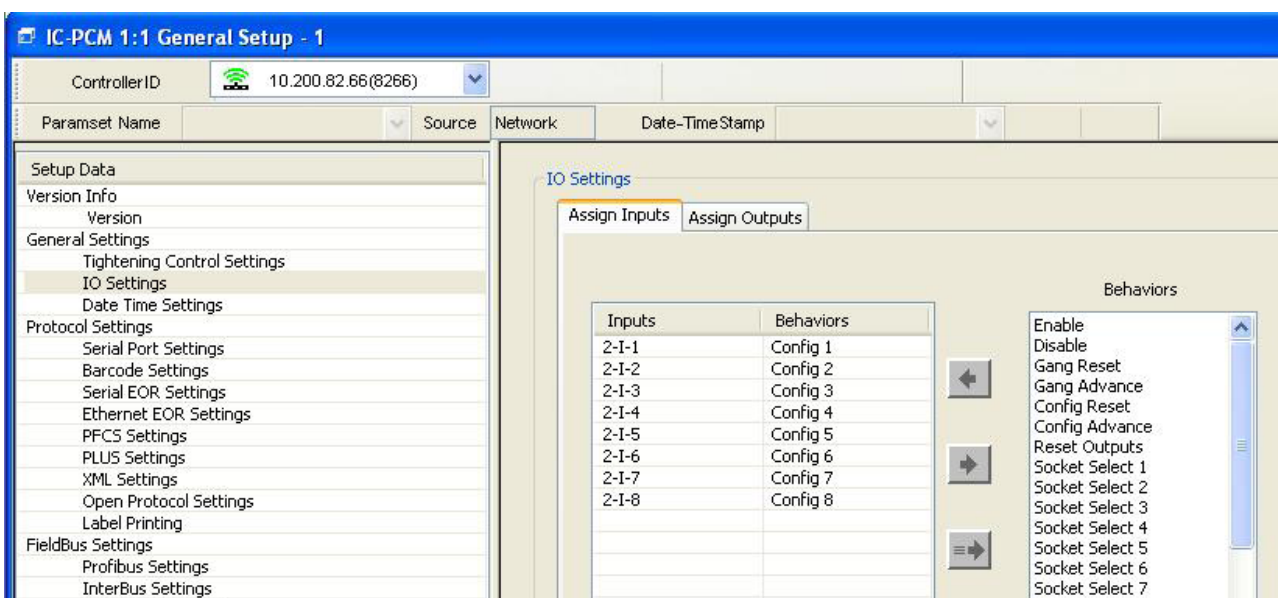
The Assign Inputs tab provides a method of assigning input behaviours to physical input pin of the IC-PCM 1:1. The screen provides a list of input behaviours for programming the input pins. The screen also provides the flexibility of positioning the input behaviours and restricts duplicate assignments of same behaviours for different input pins of the IC-PCM 1:1.



Input Pin/Behaviours List	<p>This List displays the Current inputs behaviours versus input pins (2-I-1 to 2-I-8).</p>
----------------------------------	---

<p>Behaviour's list</p>	<p>The "Behaviours" List displays all the available behaviours which are not been assigned to any of the input pins. Following are the list of input behaviours</p> <ul style="list-style-type: none"> -"Configurations 1-8" behaviours select the configuration number of the tool mapped tool to the IC-PCM 1:1 -"Enable" behaviour Enables the tool to perform the tightening operation -"Disable" behaviour disables the tool from performing the tightening operation -"Gang Reset" behaviour resets the Current gang count to 0. -"Gang Advance" behaviour Advances the current Gang Count by one in case of Fail cycle. -"Config Reset" behaviour resets back to the Configuration number of the mapped tool to configuration number which is programmed in the active configuration -"Reset Outputs" behaviour resets all output pins to non-active condition. -"Config Advance" behaviour advances to the next configuration number which is programmed in the active configuration. -"Socket Select 1-8" behaviour which is used in a socket tray setup to know which socket number is selected for the corresponding configuration. -"User Input 1-8" behaviours are used for receiving the Field bus device input commands to the IC-PCM 1:1. -"Reprint Label" behaviour is used to resend a label to the label printer connected to the IC-PCM 1:1. "PLUS Manual Reset" behaviour resets the PLUS communication in the IC-PCM 1:1.
<p>Assign Input button</p> 	<p>The "Assign" Input button is used to assign the selected input behaviour to the selected input pin of the IC-PCM 1:1.</p> <p>Select the input pin (2-I-1) from "Input Pin /Behaviours List" and the appropriate behaviours from "Behaviours" list and click on Assign button (left pointing arrow) for assigning the behaviour to the selected input pin.</p>
<p>Un-Assign Input button</p> 	<p>The "Un-Assign" Input button is used to un-assign an input behaviour from the programmed input pin.</p> <p>Select the input pin (2-I-x) from "Input Pint/Behaviours List" and click on the "Un-Assign" (right pointing arrow) button to un-assign the behaviour from the selected input pin.</p>
<p>"Un-Assign All" button</p> 	<p>The "Un-Assign All" button is used for un-assigning all the input behaviours from the programmed input pins (2-I-1 to 2-I-8).</p>

Output settings

The Assign Outputs tab provides a method of assigning output behaviours to physical output pins of the IC-PCM 1:1. The screen provides a list of output behaviours to select and assign to the desired output pins. The screen also provides the flexibility of positioning the output behaviours to the output pins of the IC-PCM 1:1. The Outputs will remain 'ON' (active) until the specified 'Time' interval has elapsed. The default 'Time' is 0. With this value the Outputs will remain 'ON' (active) until the next EOR data is received or the 'Reset Outputs' Input is turned 'ON'.

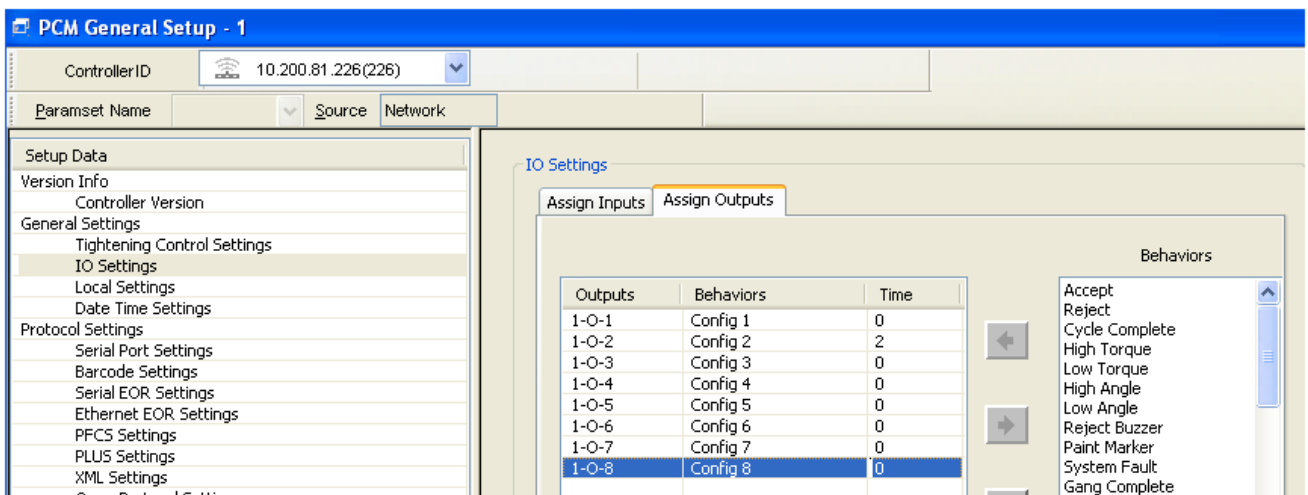

<p>Output Pin/ Behaviours List</p>	<p>This List displays the Current output behaviours versus output pins (1-O-1 to 1-O-8) on to the IC-PCM 1:1</p>
---	--

Behaviour's list	<p>The "Output Behaviours" List displays all behaviours. Following are the list of output behaviours</p> <ul style="list-style-type: none"> - "Accept" behaviour is HIGH when tightening sequence is "OK" for the tool mapped to the IC-PCM 1:1. - "Reject" behaviour is HIGH when tightening sequence is "NOT OK" for the tool mapped to the IC-PCM 1:1. - "Cycle Complete" behaviour is HIGH when the tightening sequence is completed irrespective to the Pass/Fail status of the tool mapped to the IC-PCM 1:1 - "High Torque" behaviour is HIGH when the final Torque result is greater than or equal to Torque High Limit programmed for the configuration. - "Low Torque" behaviour is HIGH when the Final torque result is below the Torque Low Limit programmed for the configuration. - "High Angle" behaviour is HIGH when the final Angle result is greater than or equal to the Angle High Limit programmed for the configuration - "Low Angle" behaviour is HIGH when the Final angle value of the tightening results is less than the angle Low Limit of the tool mapped to the IC-PCM 1:1. "Reject Buzzer" is HIGH when the tightening sequence is "NOT OK" "Paint Marker" is HIGH when the tightening sequence is "OK" "System Fault" HIGH Indicates a problem with the IC-PCM 1:1. "Gang Complete" is HIGH when "Gang Complete" occurs "Config 1-8" is HIGH when the particular Configuration is selected on the tool. "Socket Select 1-8" is HIGH when a Configuration is selected that has the particular Socket Selection Number assigned to it. User Output 1-8" is HIGH when turned 'On' by one of the Fieldbus Protocols.
Assign output button	<p>The "Assign" output button is used for assigning the output behaviours to the selected output pin of the IC-PCM 1:1.</p> <p>Select the output pin (1-O-x) from "output Pin /Behaviours List" and the appropriate behaviour from "Behaviours" list. Click on Assign button (left pointing arrow) to assign the behaviour to the selected output pin.</p>
Un-Assign Input button	<p>The "Un-Assign" output button is used for un-assigning the output behaviours from the programmed output pin.</p> <p>Select the output pin (1-O-x) from "Output Pin /Behaviours List" and click on the "Un-Assign" (right pointing arrow) button to un-assign the behaviour from the selected output pin.</p>
"Un-Assign All" button	<p>The "Un-assign All" button is used for un-assigning all the output behaviours from the programmed output pins (1-O-1 to 1-O-8).</p>
Set time	<p>To set a time out period for the output pin, enter a time in seconds in the Time column. If output time is set to zero, the output pin will remain active until the next cycle is complete. Otherwise the output pin will go low after the time out period.</p>

NOTE: For safety reasons, newly assigned Input or Output behaviours on the IC-PCM-1:1 will not take effect until the IC-PCM 1:1 is rebooted.

3.2.2.3 Socket Tray and Configuration Switch Connection and Setup using IC-PCM 1:1

- Map the QX Series wireless tool to the IC-PCM 1:1.
- Using ICS Application, Enable the Smart socket feature in the IC-PCM 1:1 from General setup screen.
- Program Behaviours of configuration number and socket numbers to Inputs/Outputs behaviours of the IC-PCM 1:1 from IC-PCM 1:1 General setup screen.

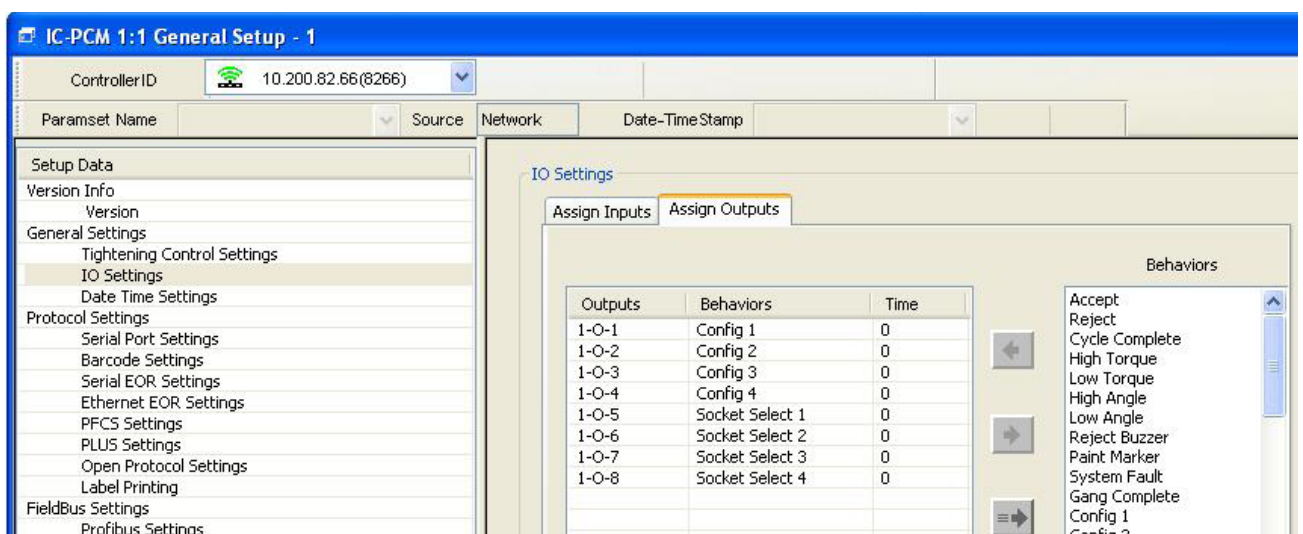
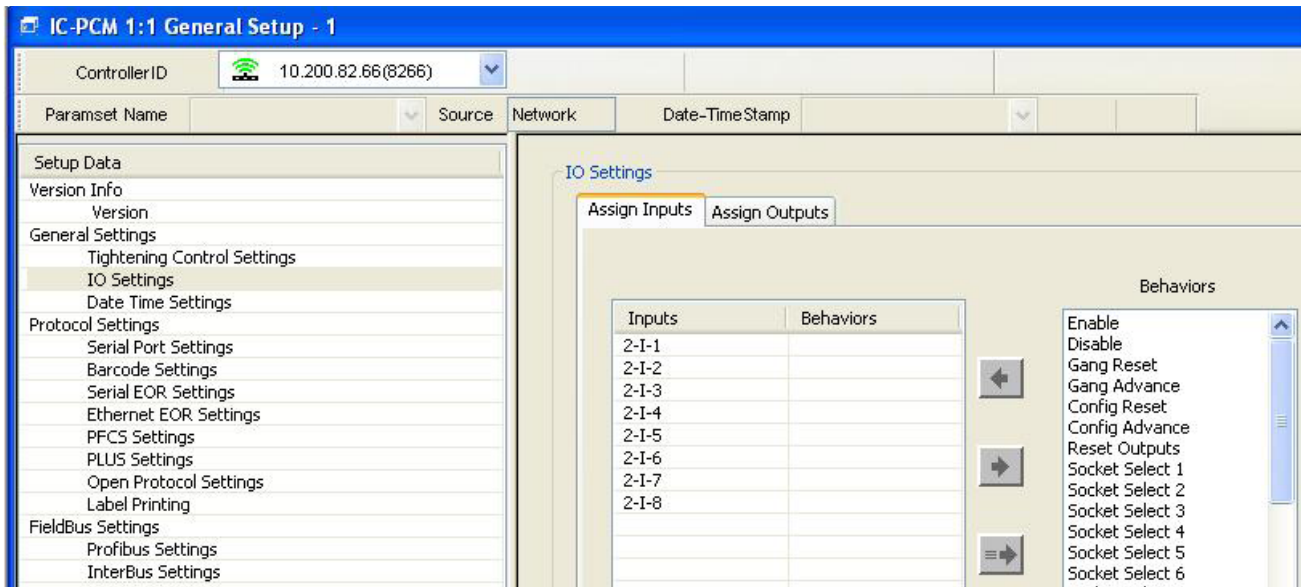

- Enable the “Enable Smart Socket” check box from Tool general setup screen.
 - For above assigned configuration numbers, program the Tightening configuration and its corresponding socket number from tightening configuration screen.
 - Connect the Socket Tray Input lines/Output lines to the IC-PCM 1:1 terminal blocks and verify all the pins are working correctly using the diagnostics View Input/ Output screen. To run the tool, select configuration number using the external input signal to the IC-PCM 1:1 , ICS or Fieldbus, or from the tool display. The IC-PCM 1:1 then sends out the corresponding socket number output signal to the Socket tray. Lift the corresponding socket for the selected configuration. Tool will now be in unlocked state to run its configuration.
- NOTE:** Tool will not run its configuration if more than one socket removed from the tray or wrong socket is removed.

3.2.2.4 Light Box Connection and Setup

- Locate the active wire colors for light boxes.
- Connect the light box to the IC-PCM 1:1 terminal blocks with the appropriate accessory cable.
- Ensure a QX Series wireless tool is mapped to the IC-PCM 1:1.
- From IC-PCM 1:1 General Setup screen, assign the output behaviours for the corresponding terminal blocks.
- In a standard setup, the colored lamps indicate the following:
 - Red : Torque/Angle High.
 - Green : Accept output.
 - Yellow : Torque/Angle Low.

3.2.2.5 Date Time Settings

The Date Time settings allows the user to set the Date and Time settings for IC-PCM 1:1.

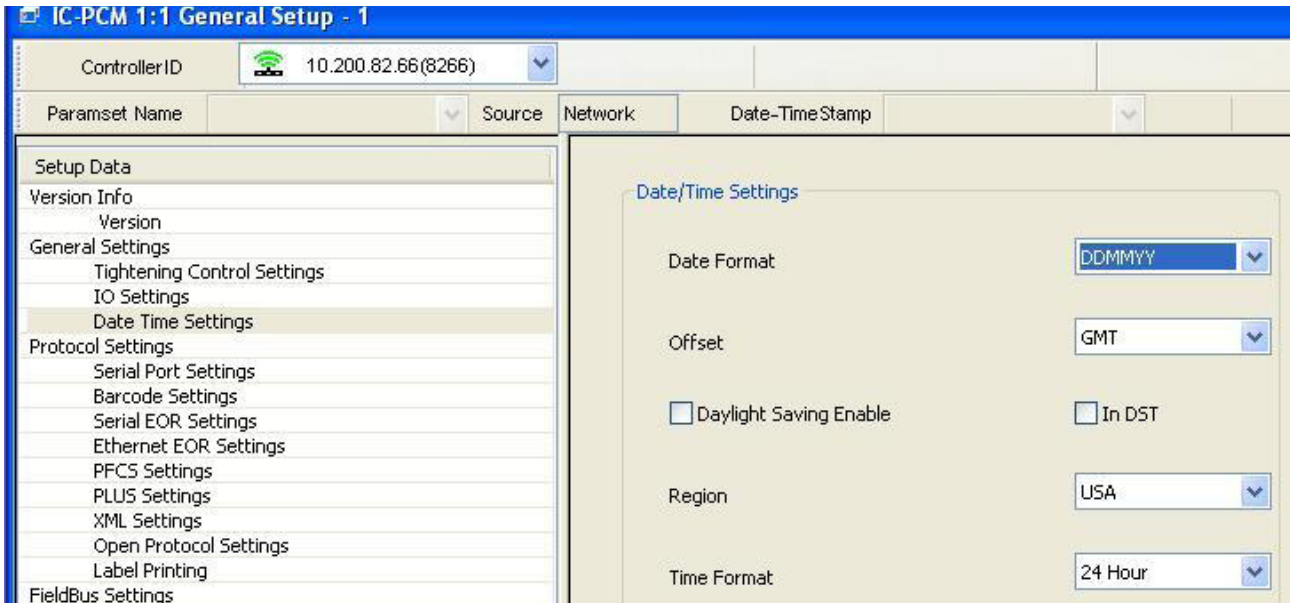

Date Format	Date Format drop box allows the user to set the date format for the IC-PCM 1:1 (MMDDYY and DDMMYY).
Offset	Offset drop box allows the user to set the current time zone for the IC-PCM 1:1. Following are the options for Offset time zone – GMT-12, GMT-11, GMT-10, GMT-9, GMT-8, GMT-7, GMT-6, GMT-5, GMT-4, GMT-3:30, GMT-3, GMT-2, GMT-1, GMT, GMT+1, GMT+2, GMT+3, GMT+3:30, GMT+4, GMT+5, GMT+5:30, GMT+5:45, GMT+6, GMT+6:30, GMT+7, GMT+8, GMT+9, GMT+9:30, GMT+10, GMT+11, GMT+12, GMT+13.
Daylight Saving Enable	Daylight Saving option is used for enabling or disabling automatic time adjustment for daylight savings of selected country
In DST	The time format which received from the IC-PCM 1:1 is in daylight savings format.
Time Format	Time Format allows setting the current time in 12/24 Hour format.

3.2.3 Protocol Settings

The Protocol Assignment settings tab provides options for assigning protocols and customizing them for the various communications ports. The following are the different protocols that can be assigned to each available port.

3.2.3.1 PCM Serial Port Settings

This setting allows to set the “serial Port settings” of the IC-PCM 1:1.

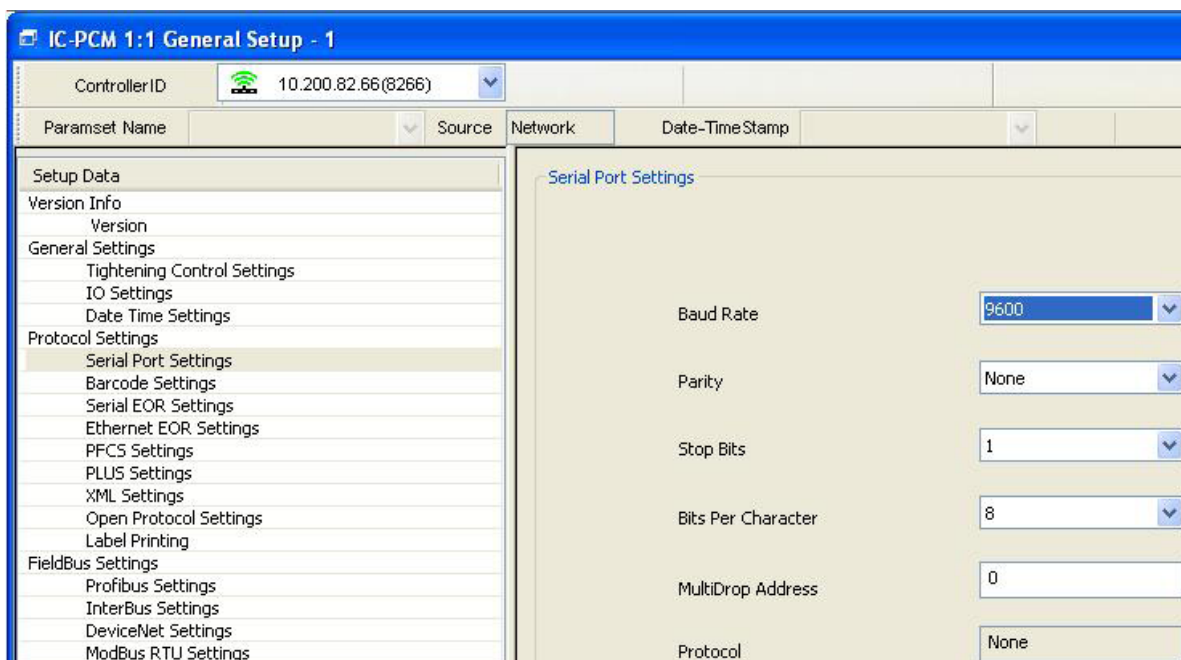

Baud Rate	Baud Rate sets the speed for communications of serial port. Following are the baud rates which can be set from ICS 110, 1200, 2400, 4800, 9600, 14400, 19200, 28800, 38400, 57600, 76800, 115200.
Parity	Parity sets the parity for the serial connection to None, Odd, Even
Stop Bits	Stop Bits sets the number of Stop bits to 1 or 2
Bits Per Character	Bits Per Character sets the Bits Per Character parameter to 7 or 8
Multi Drop Address	Multi Drop Address sets the address number for use with Host Data Out protocol.
Protocol	Protocol indicates which protocol is set for the Serial port, such as "Serial Barcode", "Serial EOR", "PLUS Barcode" and "Label Printing"

3.2.3.2 Barcode/VIN Settings

Barcode/VIN settings allow the user to set the Barcode related settings such as length, criteria, From/To characters for criteria match. Barcode scanner input can be set for different types of Standard communications ports (Ethernet /Serial) of the IC-PCM 1:1.

Other protocols such as ProfiBus or DeviceNet can also input a Barcode or VIN number to the IC-PCM 1:1, but the barcodes are not subject to criteria checking.

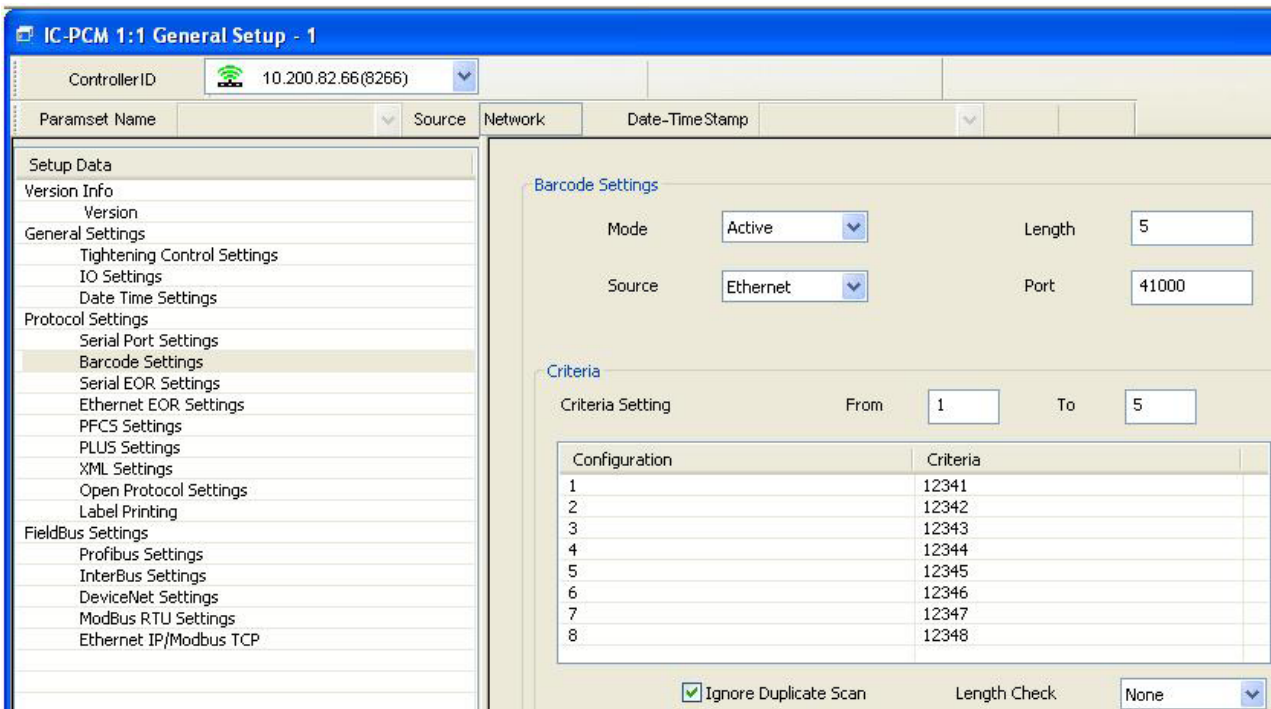

Mode	<p>Modes in the Barcode settings allows to set Two Types of mode "Passive" & "Active"</p> <p>Passive mode: Attaches the barcode string to the End Of Run Data received from the tool without any criteria comparison. Barcode information is stored locally in the IC-PCM 1:1 cycle log data but not in the tool cycle log data.</p> <p>Active mode: Has all the functionality of Passive mode and the additional functionality of allowing the Barcode/VIN to select configuration number on the tool.. Valid Barcode/VINs are identified based on the characters in the barcode that should match the criteria set for corresponding configuration number. If successful then it attaches the Barcode string to the EOR data.</p> <p>OFF mode: Disables the barcode operation for the IC-PCM 1:1. "No BCode" will be attached to the EOR data. OFF mode will set the barcode operation in disabled mode for IC-PCM 1:1. "No BCode" will be attached for the tightening cycle received from the mapped tool.</p>
Length	Set the max length of the Barcode string (this is the total number of characters in the barcode.) The Max length for the Barcode string for the IC-PCM 1:1 is 40.
Source	Source can be either Serial/Ethernet of the IC-PCM 1:1.
From	Sets the beginning (character #) of the criteria string range
To	Sets the end (character #) of the criteria string range.

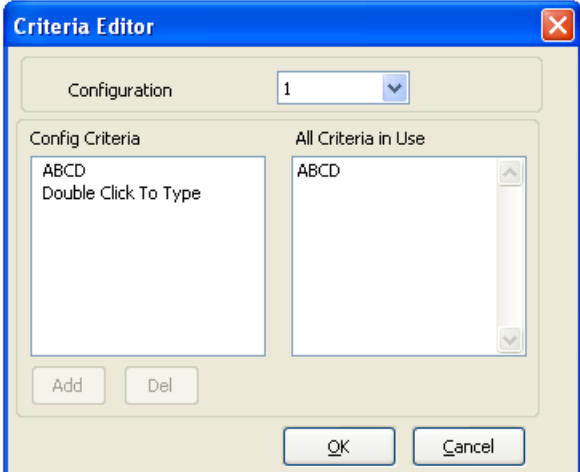
<p>Criteria Settings</p>	<p>Criteria settings displays all the criteria strings programmed for the configuration number (1-8). Double clicking on a row entry opens up the Criteria Editor dialog Box. Select the Configuration from the drop down list and then double click on the Config Criteria text entry box. Enter the character strings with length matching the From/To value to identify a valid Barcode/VIN. Click OK to save the settings in the criteria settings list.</p> 
<p>Ignore Duplicate Scan</p>	<p>Enable "Ignore duplicate scan" will ignore the scanned barcode from the IC-PCM 1:1 if it is identical to previously scanned barcode. "Invalid BC" is recorded as the scan data for passive mode. In the case of Active mode, the configuration selection will not be sent to the tool mapped to the IC-PCM 1:1.</p>
<p>Length Check</p>	<p>Length check allows the user to set the maximum allowable length of the barcode. "None" option: Will not restrict the scanned barcode length. "Restrict" option: Will validate the scanned Barcode length with the value set in the length input box. If it exceeds the set length value, "Invalid BC" is recorded as the scan data for passive mode. Configuration number will not be selected in the tool in active mode . "Truncate Left": Truncates the scanned barcode string from left hand side until it matches the value set in the length input box. "Truncate right": Truncates the scanned barcode string from right hand side until it matches the value set in the length input box.</p>

NOTE: one serial protocol settings can be programmed on the IC-PCM 1:1 serial port at a time.

3.2.3.3 Barcode Connection and Setup using IC-PCM 1:1

- Connect ASCII barcode scanner to the serial port of the IC-PCM 1:1. For Ethernet Barcode scanner, connect the scanner to the Ethernet port of a serial to Ethernet device on the network.
- Using ICS application, program the IC-PCM 1:1 serial port settings to match settings on the bar code scanner.
- The barcode scanner must be configured to add a CR/LF at the end of each barcode.
- Using ICS application, enable the Serial Barcode Protocol for the IC-PCM 1:1
- The barcode function has two main operating modes, Passive and Active. The Barcode settings can be programmed using ICS software.
- Using Active mode, a particular configuration number can be selected using Barcode.
- Turn on Barcode scanner.
- When the barcode function is enabled for a IC-PCM 1:1 and when the cycle data is sent by the tool, the scanned bar code data is added to EOR data. If a cycle is run before a barcode is scanned then the bar code data is recorded as "No BCode". When a barcode is scanned and is of valid length, then the scan data is recorded to all subsequent cycles until a new scan is initiated. If an invalid barcode is scanned, "Invalid BC" is recorded as the scan data.

3.2.3.4 Serial EOR Settings

Serial EOR Settings enables sending of EOR data for every tightening cycle of the mapped tool to the Serial port.

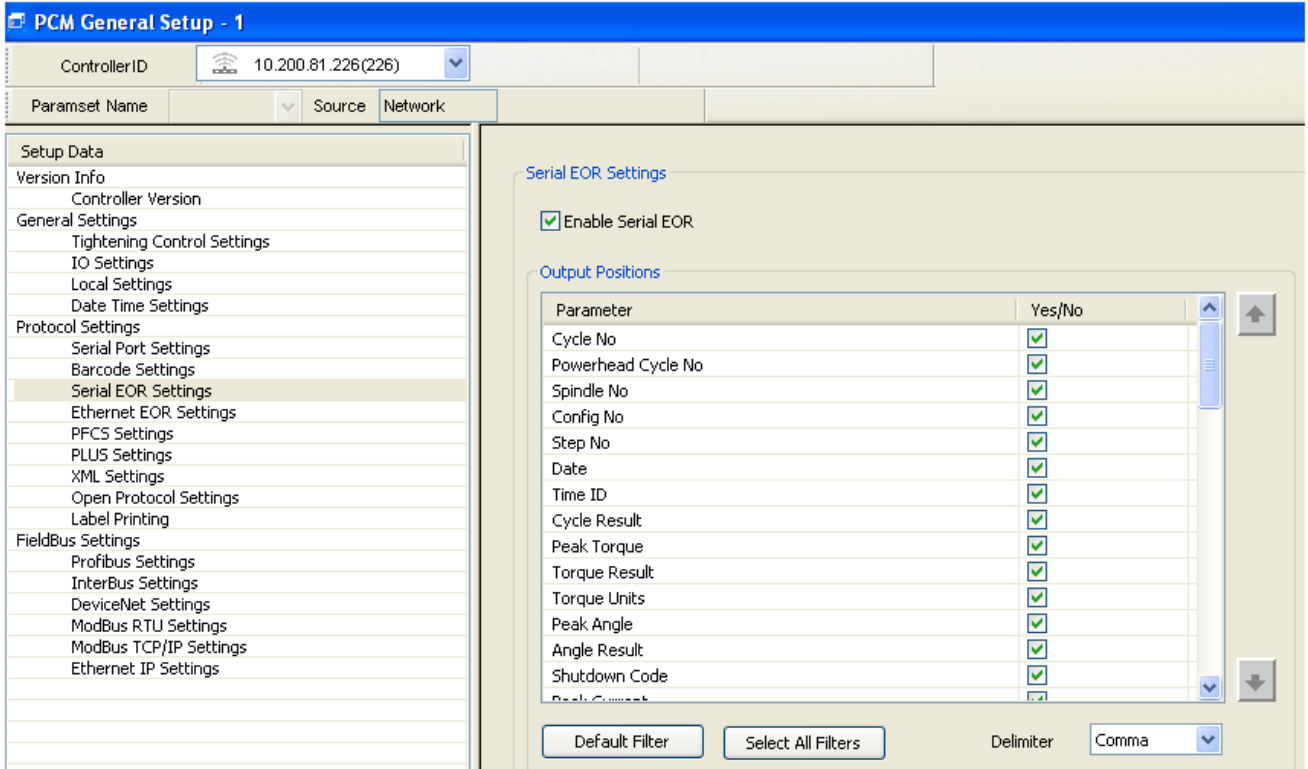

Enable Serial EOR	Enables “Serial EOR Data out” to IC-PCM 1:1.																					
Output Positions List View	Output Positions list view, displays all EOR fields and current status (Yes/No) and also the order in which EOR Data Fields appears in Serial port separated by delimiter.																					
Yes/No Check Box	Select the Checkbox next to the EOR field to include it as the part of the EOR Data Out.																					
Up/Down Arrow	The order in which EOR fields appear can be changed by clicking on a parameter and using up/down arrows to right side of “Output Positions” List.																					
Default Filter	<p>Default Filter will set the IC-PCM 1:1 to use only the default set of EOR fields for EOR Data Out to serial port. Following are the default EOR fields and order in which it appears in Serial port –</p> <table border="0"> <tr> <td>1. Cycle No</td> <td>8. Torque Units</td> <td>15. Torque Low Limit</td> </tr> <tr> <td>2. Config No</td> <td>9. Peak Angle</td> <td>16. Angle High Limit</td> </tr> <tr> <td>3. Date</td> <td>10. Angle Result</td> <td>17. Angle Low Limit</td> </tr> <tr> <td>4. Time ID</td> <td>11. Peak Current</td> <td>18. Control Point</td> </tr> <tr> <td>5. Cycle Result</td> <td>12. Cycle Time</td> <td>19. Barcode</td> </tr> <tr> <td>6. Peak Torque</td> <td>13. Strategy Type</td> <td></td> </tr> <tr> <td>7. Torque Result</td> <td>14. Torque High Limit</td> <td></td> </tr> </table>	1. Cycle No	8. Torque Units	15. Torque Low Limit	2. Config No	9. Peak Angle	16. Angle High Limit	3. Date	10. Angle Result	17. Angle Low Limit	4. Time ID	11. Peak Current	18. Control Point	5. Cycle Result	12. Cycle Time	19. Barcode	6. Peak Torque	13. Strategy Type		7. Torque Result	14. Torque High Limit	
1. Cycle No	8. Torque Units	15. Torque Low Limit																				
2. Config No	9. Peak Angle	16. Angle High Limit																				
3. Date	10. Angle Result	17. Angle Low Limit																				
4. Time ID	11. Peak Current	18. Control Point																				
5. Cycle Result	12. Cycle Time	19. Barcode																				
6. Peak Torque	13. Strategy Type																					
7. Torque Result	14. Torque High Limit																					

	Select All Filter will set IC-PCM 1:1 to use all EOR fields for EOR Data Out to serial port. Following are the EOR fields and the Order in which it appears in Serial port –		
Select All Filter	1. Cycle No	20. Job ID	40. Peak Cut-In Torque
	2. Config No	21. Powerhead Cycle No	41. Peak Prevailing Torque
	3. Date	23. Spindle No	42. Avg Prevailing Torque
	4. Time ID	24. Step No	43. Peak Drag torque
	5. Cycle Result	25. Downshift Speed	44. Avg Drag Torque
	6. Peak Torque	26. Free Speed	45. Total Gang Count
	7. Torque Result	27. TR	46. Current Gang count
	8. Torque Units	28. Dual Slope A High	47. Tool Serial Number
	9. Peak Angle	29. Dual Slope A Low	48. Shutdown Code
	10. Angle Result	30. Dual Slope B High	49. CP Result
	11. Peak Current	31. Dual Slope B Low	50. Gradient Result
	12. Cycle Time	32. Gradient High	51. Dual Slope A Result
	13. Strategy Type	33. Gradient Low	52. Dual Slope B Result
	14. Torque High Limit	34. Final Slope	53. Unusual Fault
	15. Torque Low Limit	35. Torque At Seat	54. Motor Torque Constant Test
	16. Angle High Limit	36. Angle At Seat	55. Free Speed test
	17. Angle Low Limit	37. Min Drag Torque	56. Max Tool Speed
	18. Control Point	38. Peak Slope	57. Total Angle
	19. Barcode	39. Prevailing Torque Slope	
		NOTE: Some of the above EOR fields are not part of EOR cycle generated by QX Series Tool. For those fields, the default values will be generated.	
Delimiter	Delimiter criteria to separate each EOR field in the serial EOR Data out message that appears in Serial Port of the IC-PCM 1:1. Following are the Delimiter criteria available for Serial EOR Data out protocol – “Comma”, “Space”, “Semi Colon”, “Colon”.		

NOTE: Only one Protocol (Barcode/VIN, Serial EOR Data Out, PFCS, PLUS, Label Printing) can be enabled on the serial port at a time.

3.2.3.4 Ethernet EOR Settings Serial EOR Settings:

Serial EOR Settings

Serial EOR Settings enables sending of EOR data for every cycle over the Serial port.

Turn OFF IC-PCM 1:1 and set the RED DIP switch 2 to OFF. Connect a serial null-modem cable from IC-PCM 1:1 to the PC. Launch HyperTerminal or other terminal emulation software such as Clear Terminal. Reboot the IC-PCM 1:1. The Generated EOR will be displayed in the serial terminal emulation software.

Example: If the user selects the default settings as shown below from IC-PCM 1:1 General Setup screen, the corresponding EOR will be sent to serial Port. It can then be viewed in HyperTerminal or other terminal emulation software such as Clear Terminal.

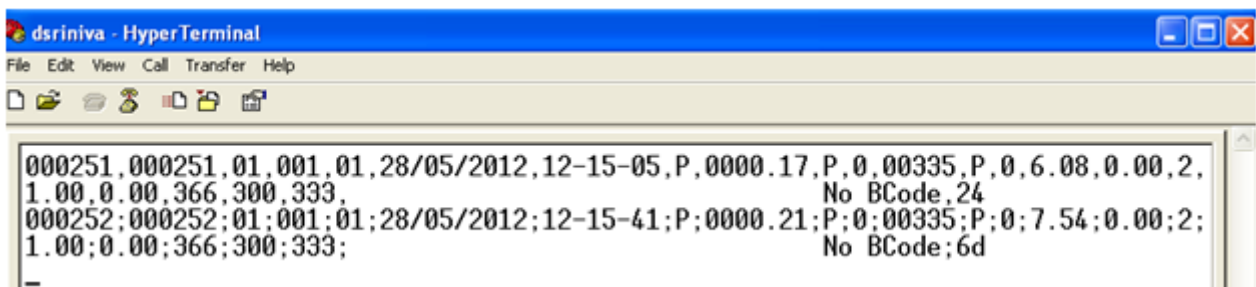
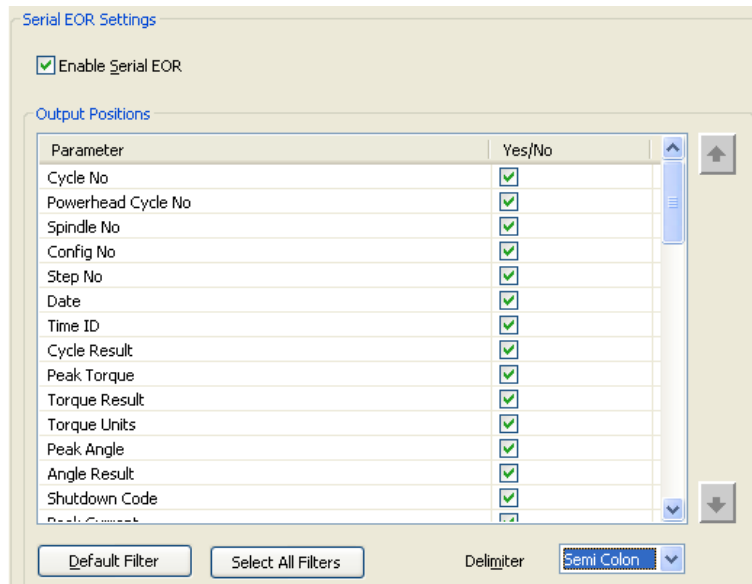

Ethernet EOR Settings enables sending of EOR data for every tightening cycle of the tool mapped to selected IC-PCM 1:1 on to the Ethernet standard communication port.

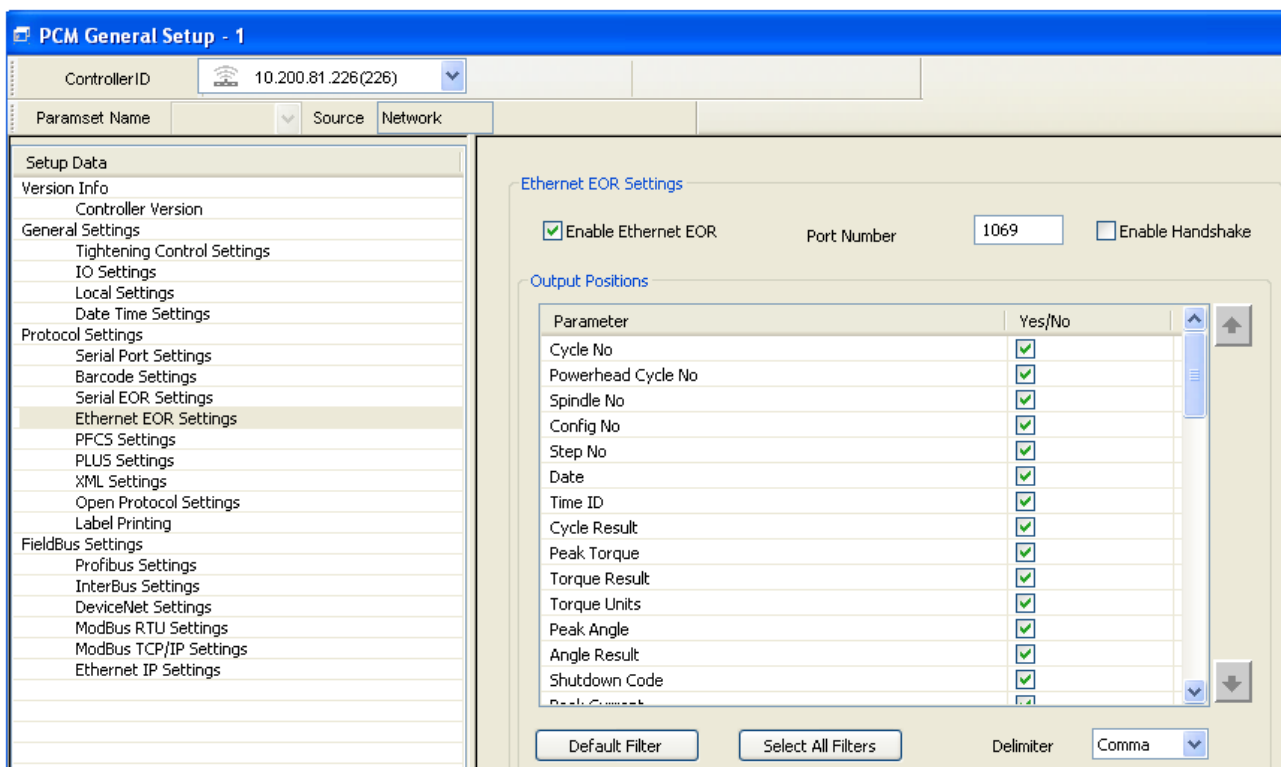

Enable Ethernet EOR	Enables the “Ethernet EOR Data out” protocol for the IC-PCM 1:1 Ethernet port.
Output Positions List View	Output Positions list view displays all the EOR fields with current status (Yes/No) and order in which EOR Data appears in Ethernet port.
Yes/No Check Box	Select the Checkbox next to the EOR field to include as the part of the EOR Data Out protocol message on to the Ethernet communication port of the IC-PCM 1:1.

Port No	The Port which is used to output the EOR. By Default ICS sets the Port number to "1069"		
Up/Down Arrow	Order in which EOR fields appear can be changed by clicking on a parameter and using the up/down arrows to right of scroll box.		
Default Filter	Select All Filter will set the IC-PCM 1:1 to use all EOR fields for EOR Data Out to serial port. Following are the EOR fields and the Order of arrangement.		
	1. Cycle No 2. Config No 3. Date 4. Time ID 5. Cycle Result 6. Peak Torque 7. Torque Result	8. Torque Units 9. Peak Angle 10. Angle Result 11. Peak Current 12. Cycle Time 13. Strategy Type 14. Torque High Limit	15. Torque Low Limit 16. Angle High Limit 17. Angle Low Limit 18. Control Point 19. Barcode
Select All Filter	Select All Filter will set the IC-PCM 1:1 to use all EOR fields for EOR Data Out to serial port. Following are EOR fields and Order of arrangement which appears in the Ethernet communication port –		
	1. Cycle No 2. Config No 3. Date 4. Time ID 5. Cycle Result 6. Peak Torque 7. Torque Result 8. Torque Units 9. Peak Angle 10. Angle Result 11. Peak Current 12. Cycle Time 13. Strategy Type 14. Torque High Limit 15. Torque Low Limit 16. Angle High Limit 17. Angle Low Limit 18. Control Point 19. Barcode	20. Job ID 21. Powerhead Cycle No 22. Spindle No 23. Step No 24. Downshift Speed 25. Free Speed 26. TR 27. Dual Slope A High 28. Dual Slope A Low 29. Dual Slope B High 30. Dual Slope B Low 31. Gradient High 32. Gradient Low 33. Final Slope 34. Torque At Seat 35. Angle At Seat 36. Min Drag Torque 37. Peak Slope 38. Prevailing Torque Slope	39. Peak Cut-In Torque 40. Peak Prevailing Torque 41. Avg Prevailing Torque 42. Peak Drag torque 43. Avg Drag Torque 44. Total Gang Count 45. Current Gang count 46. Tool Serial Number 47. Shutdown Code 48. CP Result 49. Gradient Result 50. Dual Slope A Result 51. Dual Slope B Result 52. Unusual Fault 53. Motor Torque Constant Test 54. Free Speed test 55. Max Tool Speed 56. Total Angle
	NOTE: Some of the above EOR fields are not part of EOR cycle generated by QX Series Tool. For those fields, the default values will be generated.		
Delimiter	Delimiter criteria to separate each EOR field in Ethernet EOR Data out message that appears in Ethernet Port of IC-PCM 1:1. Following are Delimiter criteria available for Ethernet EOR Data out protocol – "Comma", "Space", "Semi Colon", "Colon".		
Enable Handshaking	Option provided for Enable/Disable Handshaking. Enable Handshaking requires acknowledgement to be sent to IC-PCM 1:1 for each of the EOR Cycles. In case of Disable handshaking, IC-PCM 1:1 will not expect the acknowledgement for every EOR cycles.		

NOTE: IC-PCM 1:1 requires Reboot for any of the Ethernet protocol settings.

3.2.3.5 Ethernet EOR Setup

Ethernet EOR Settings enables sending of EOR data for every EOR over Ethernet port. IC-PCM 1:1 sends EOR to programmed Ethernet port. This can be verified using Ethernet EOR Test Tool.

Ethernet EOR Test Tool Setup:

- Click on Option Button. Enter IC-PCM 1:1 IP Address. Click on OK button

- Click on Connect button to IC-PCM 1:1 establishes the communication. Click on Login PREAD and then click on "Standard EOR Act" to view the default EOR Field format.

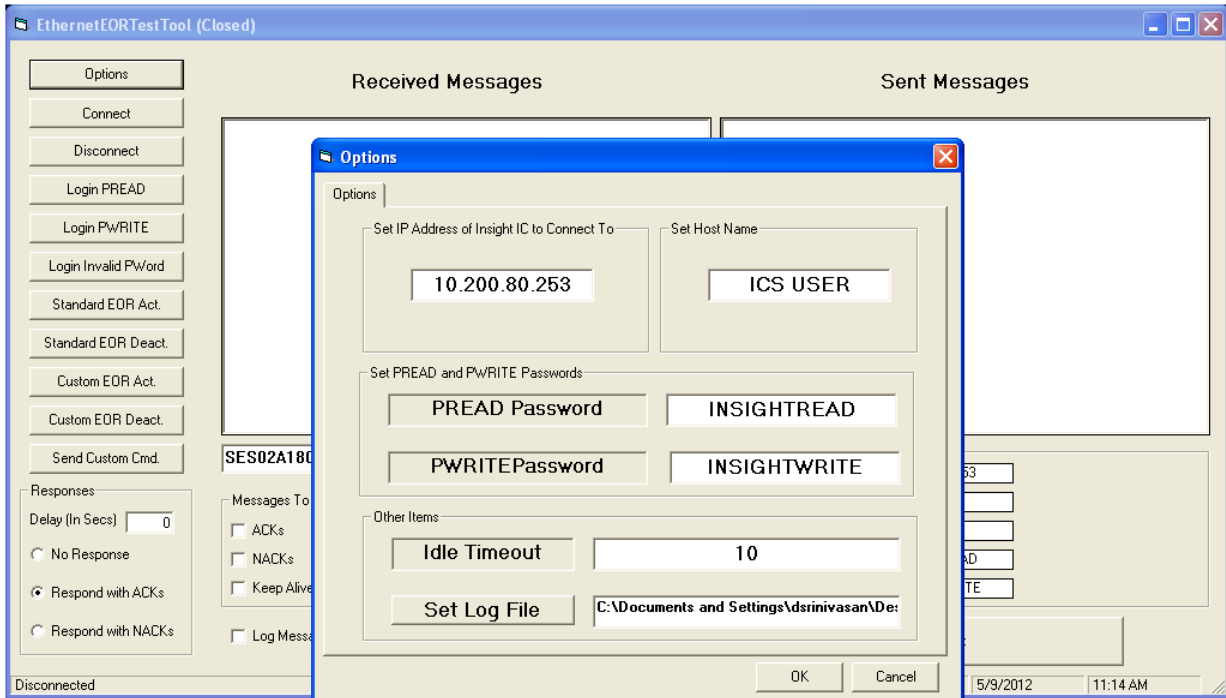

- IC-PCM 1:1 sends Received EOR data to programmed Ethernet port in Standard EOR Format which can be viewed in the Ethernet EOR test tool.

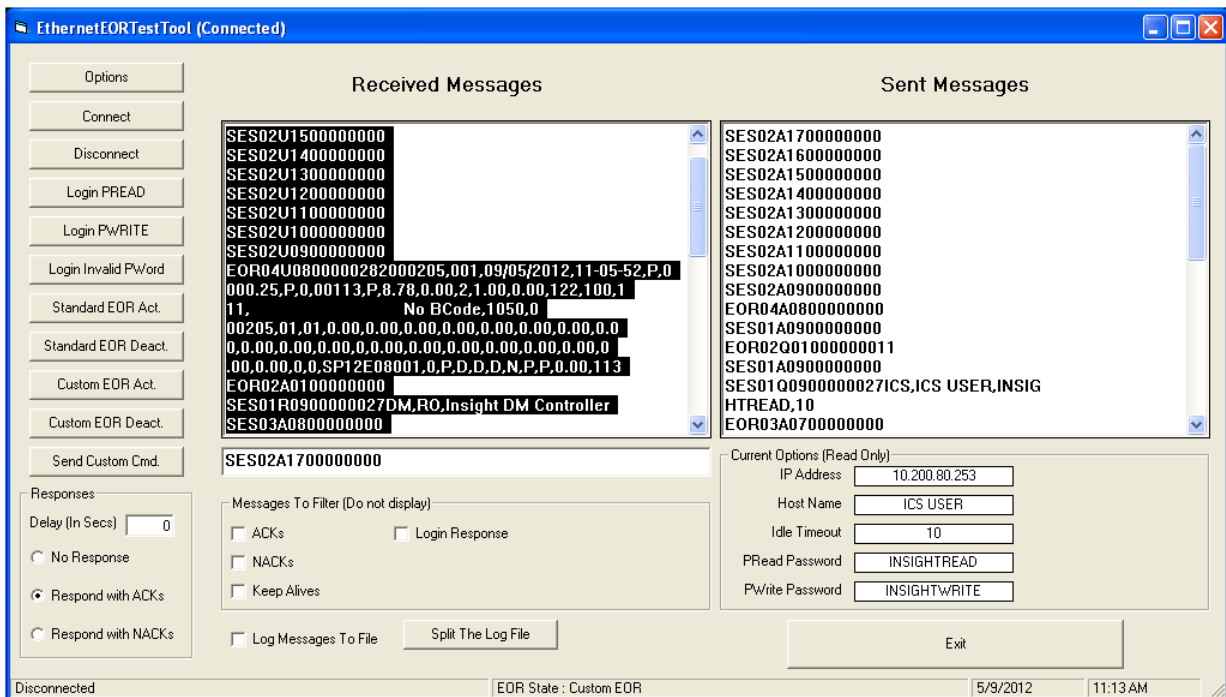

To view the Customized EOR fields, click on "Customer EOR Act". IC-PCM 1:1 sends EOR data to programmed Ethernet port in Customized EOR Format which can be viewed in the Ethernet EOR test tool.

NOTE: If standard EOR act is activated then deactivate by clicking on "Deactivate Standard EOR Act" button and Click on "Customer EOR Act".

3.2.3.6 PFCS Settings

PFCS Settings provides ability to program the settings to communicate between Plant Floor Communication System (PFCS) and IC-PCM 1:1. The PFCS interface acquires EOR Cycle Data and sends it to their system for acquisition, archiving and analysis purposes.

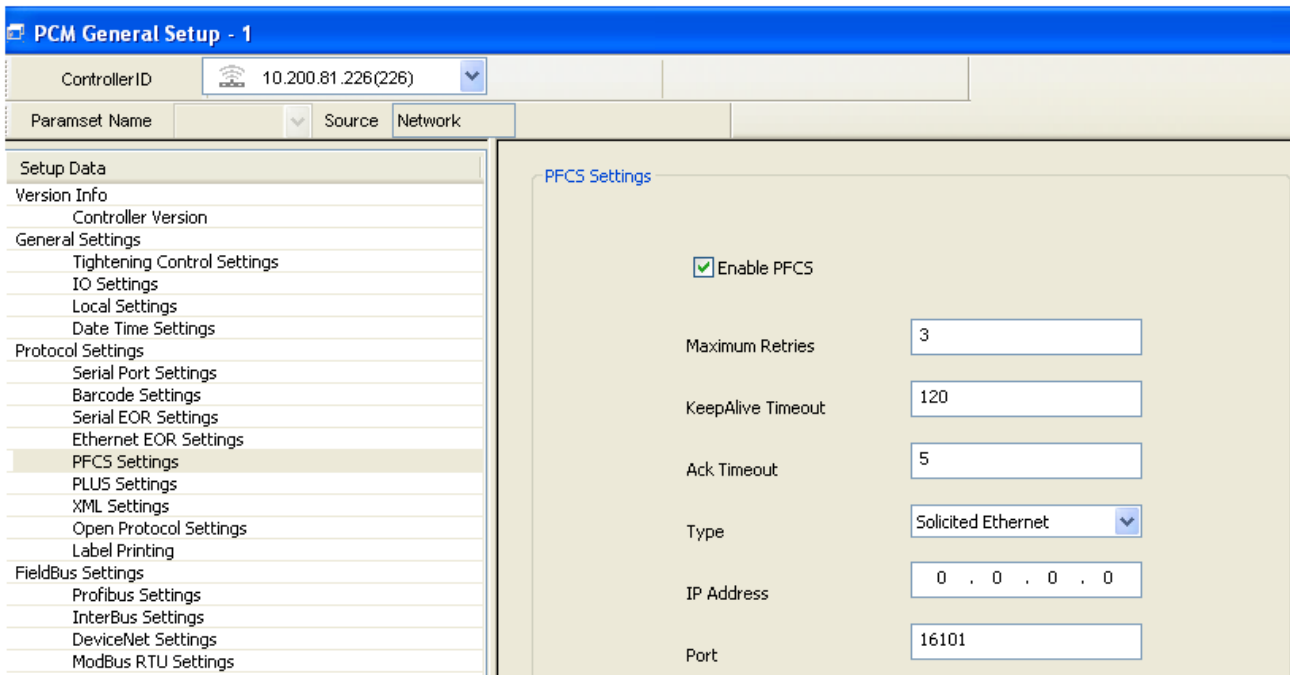

Enable PFCS	Enables "PFCS" protocol on to the IC-PCM 1:1 Ethernet port.
Maximum Retries	Maximum number of retries for each message.
Keep Alive timeout	Keep alive timeout (0-9999) is the timeout value for the Keep alive message to the PFCS Server
ACK Timeout	Timeout value for receiving the reply from PFCS server.
Type	IC-PCM 1:1 can communicate with PFCS server using Serial/Ethernet.
IP Address	IP address of PFCS Server
Port	Port number to communicate with PFCS Server.

3.2.3.7 Communication via Serial:

1. Enable PFCS and select Type as Serial for IC-PCM 1:1 using ICS Application (Refer ICS Manual).
2. Connect Serial port cable from the IC-PCM 1:1 to the machine where PFCS in running.
3. Select appropriate serial Port number and establish a connection from PFCS Server to the IC-PCM 1:1.

NOTE: Make sure serial port cable is connected between IC-PCM 1:1 and system where PFCS protocol is running.

3.2.3.8 Communication via Ethernet:

1. Enable PFCS and select Type as Ethernet for IC-PCM 1:1 using ICS Application (Refer ICS Manual).
2. Reboot the IC-PCM 1:1 after 30 seconds.
3. Establish a connection from PFCS Server to IC-PCM 1:1.

NOTE: Make sure Ethernet port (RJ45) is connected.

3.2.3.9 PLUS Settings

Plus Settings provides ability to program the settings to communicate between PLUS server and IC-PCM 1:1 The PLUS interface is used to control and acquire EOR Cycle Data and send it to their system for acquisition, archiving and analysis purposes.

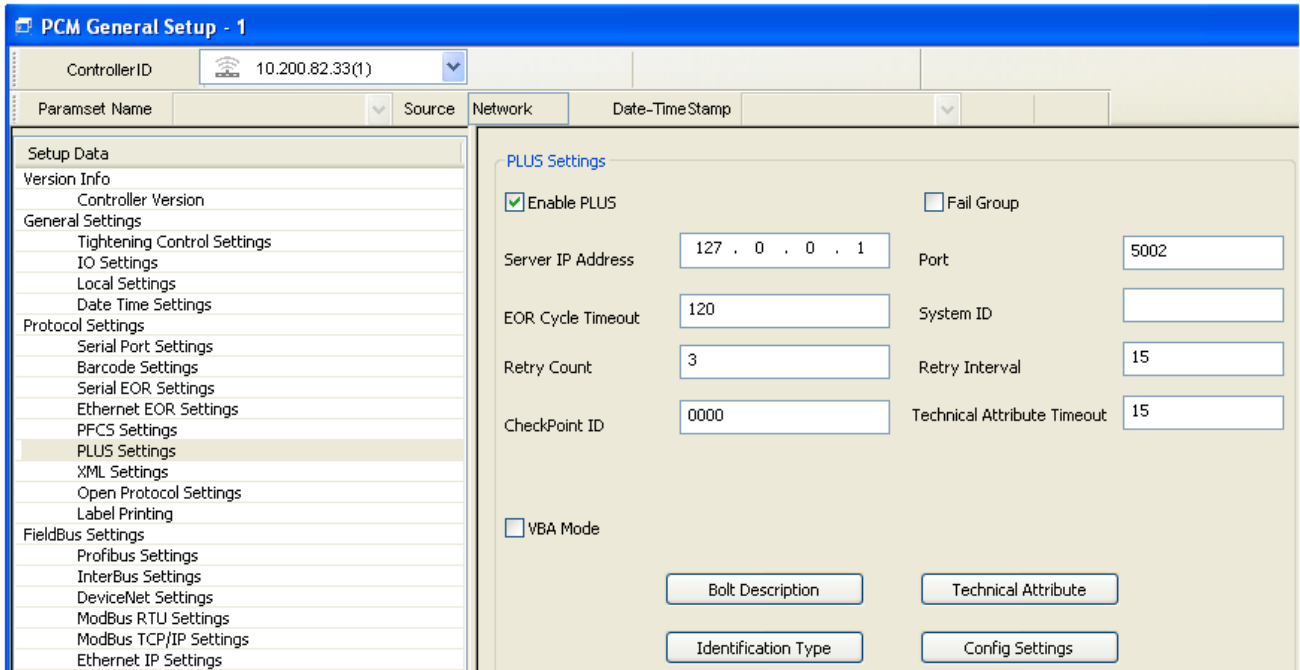

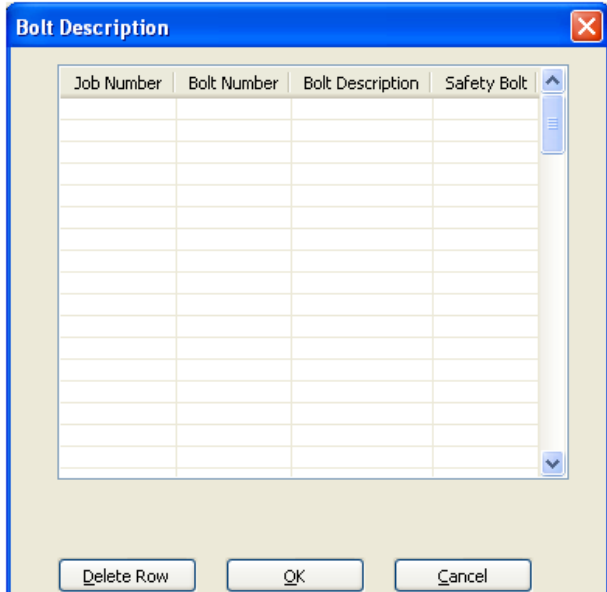
Enable PLUS	Enables the “PLUS” protocol on to the IC-PCM 1:1 Ethernet port. NOTE: PLUS also uses the Serial Port settings for reading Barcode information. Any other serial protocols which are programmed for serial port settings will not allow enabling the PLUS Protocol.
Server IP Address	IP address of PLUS Server.
Port	Port number to communicate with PLUS Server.
EOR Cycle Time Out	The timeout value for all bolts to be completed for the part before the assembly is aborted and the results sent to the server.
System ID	The user specified system identification.
Retry Count	The maximum number of times to retry a message before resetting communications.
Retry Interval	The period of time to wait between message retries.
Check Point ID	The user specified checkpoint identification.
Technical Attribute Timeout	Technical Attribute Timeout sets timeout between a Request/Replay for Technical Attributes
VBA Mode	Setting this value puts the PLUS into an asynchronous mode.
Bolt Description	Bolt Description allows opening the dialog box for entering the bolt description for each bolt no. 

Technical Attribute

Technical Attribute allows opening the Dialog box for entering all the technical Attribute information

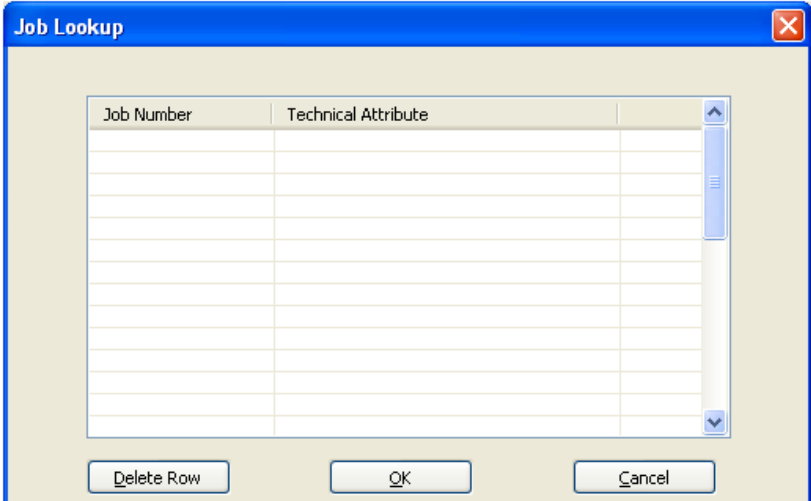

Identification Type

Identification Type allows opening the Dialog box for selecting three fixed Identification Type to determine the message ID

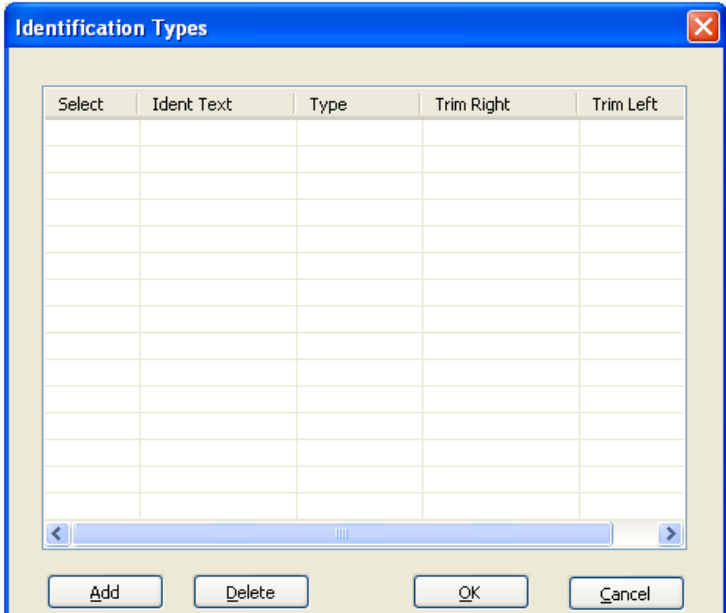

Config Settings

Config Settings allows opening the Dialog box for Selecting configuration number and entering next Configuration number in the auto increment chain and corresponding total Gang count which is programmed for the selected configuration number.

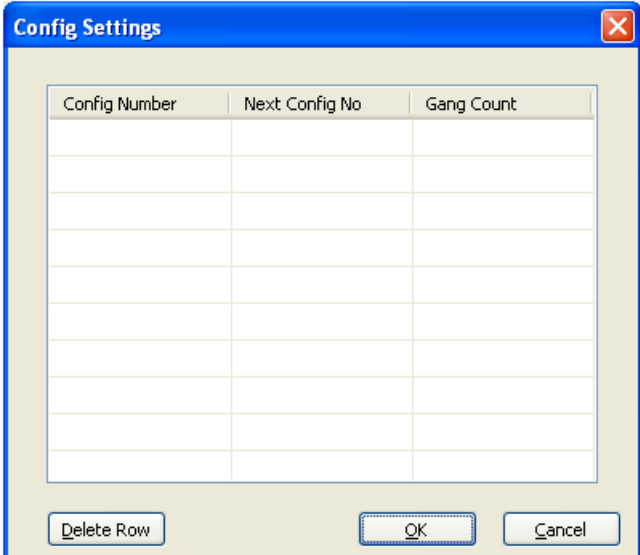

3.2.3.10 XML Settings

XML Settings enable's the IC-PCM 1:1 to communicate with the SPS/PC Master server and sends the EOR results in the XML format.

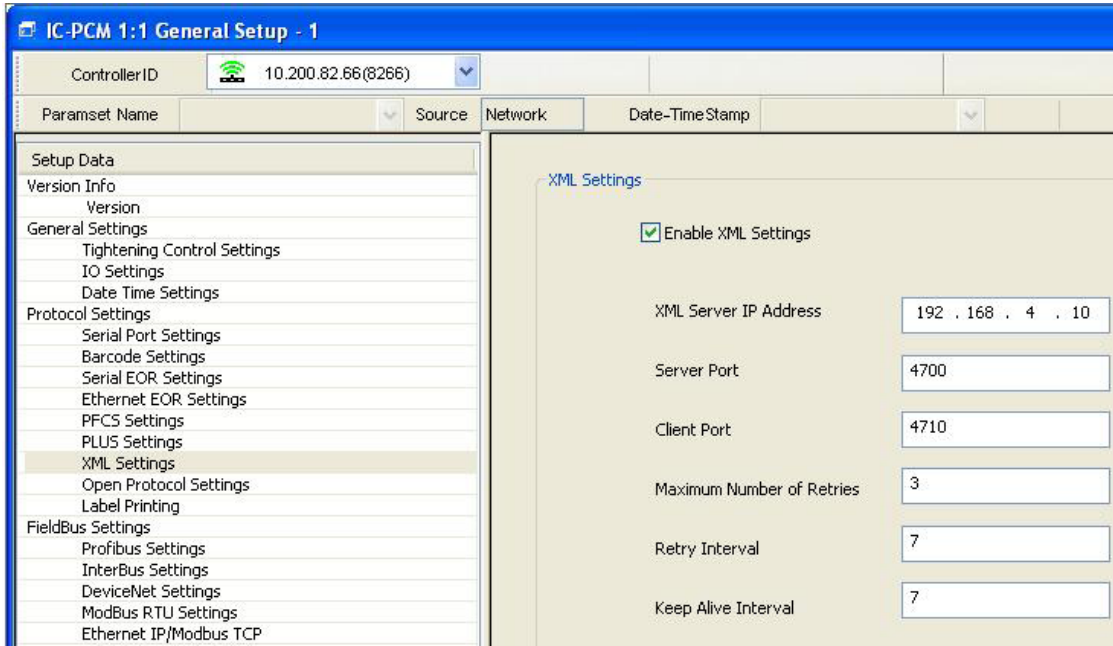

Enable XML	Enables “XML” protocol on to IC-PCM 1:1 Ethernet port.
Server IP Address	IP address of the SPS/PC Master XML Server
Server Port	Server Port number to communicate with SPS/PC Master.
Client Port	Client Port number for IC-PCM 1:1 to communicate with SPS/PC Master.
Maximum Number Of Retries	Maximum number of retries for each message.
Retry Interval	Time interval between each retries.
Keep Alive Timeout	Keep alive out (0-9999) is timeout value for Keep Alive message and SPS/PC Master Server.

3.2.3.11 XML setup using IC-PCM 1:1

The XML protocol communicates with an XML master control system, (SPS), as described in the VW XML Interface. doc. The communication between master (PC I SPS) and Slave (PCM) is done based on TCP/IP-Protocol family via TCP-Sockets.

- Two communication channels exist with their own Ports A and B that can be set by ICS software. The master acts as the Client for checking the IC-PCM 1:1 (Port A) and sends corresponding commands to a server process of the IC-PCM 1:1 . The IC-PCM 1:1 sends event- controlled messages and process data (Port B) to a server process of the master. The preset standard values for the port numbers are 4700 for Port A and 4710 for Port B.Enable XML protocol in the XML settings screen
- Set Configuration Selection Mode to External Ethernet in the Tightening Control Settings screen
- Using Aton software, connect the master to the network
- Select subscribe to EOR from the master
- View EOR data from the IC-PCM 1:1

3.2.3.12 Open Protocol Settings

Open Protocol Settings provides the ability to communicate between Open Protocol server and IC-PCM 1:1 to acquire EOR or Cycle Data and send it to their system for acquisition, archiving and analysis purposes.

The Open Protocol is defined in detail in the OpenProtocol_W7_7.0 specification.

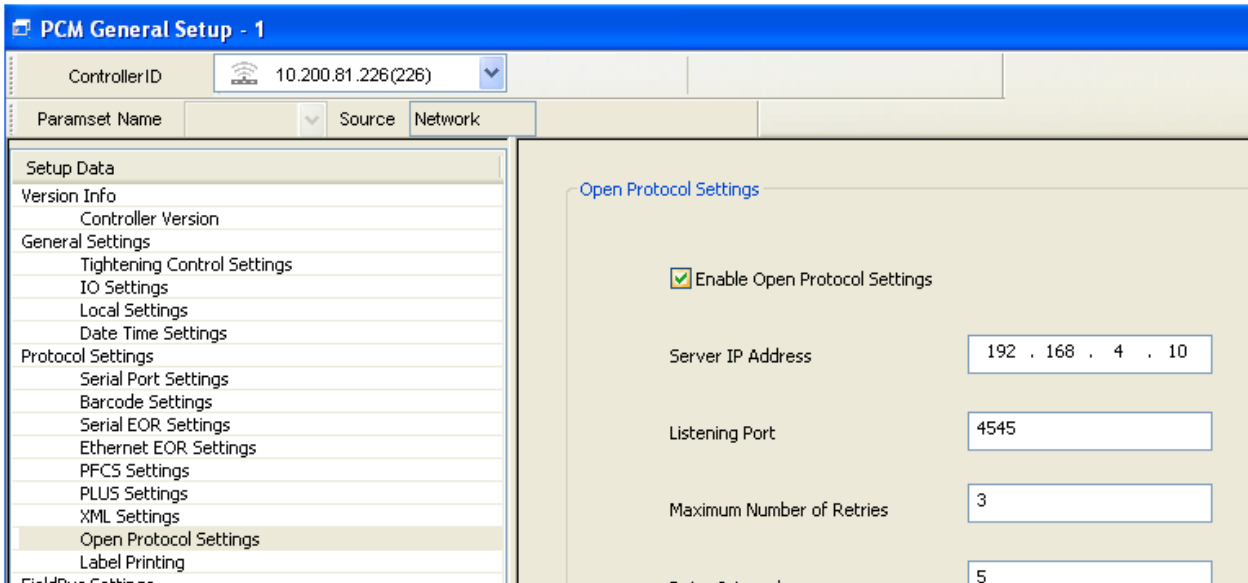

Enable Open Protocol Settings	Enables the “Open” protocol on to IC-PCM 1:1 Ethernet port.
Server IP Address	IP address of Open Protocol Server.
Listening Port	Port number to communicate with Open Protocol Server.
Maximum Number Of Retries	Maximum number of retry if Request is failed
Retry Interval	Time interval between each retries.

NOTE: Option should be set to External Ethernet for IC-PCM 1:1 to communicate with Open Protocol Server.

3.2.3.13 Open Protocol Setup

1. Setup the open protocol connection for the IC-PCM 1:1 from ICS.
2. Assign Protocol Online output to any of outputs using Assign I/O configuration in ICS.
3. Make sure Open protocol client is running at the port setup in the configuration.
4. Protocol Online Output should be set if connection is successful with the client.

NOTE: Make sure Ethernet port (RJ45) is connected.

3.2.3.14 Label Printing Settings

The Label Printing Feature enables IC-PCM 1:1 to print the EOR data. Once EOR data received from tool, it is then formatted and sent to serial port of IC-PCM 1:1 to which printer connected.

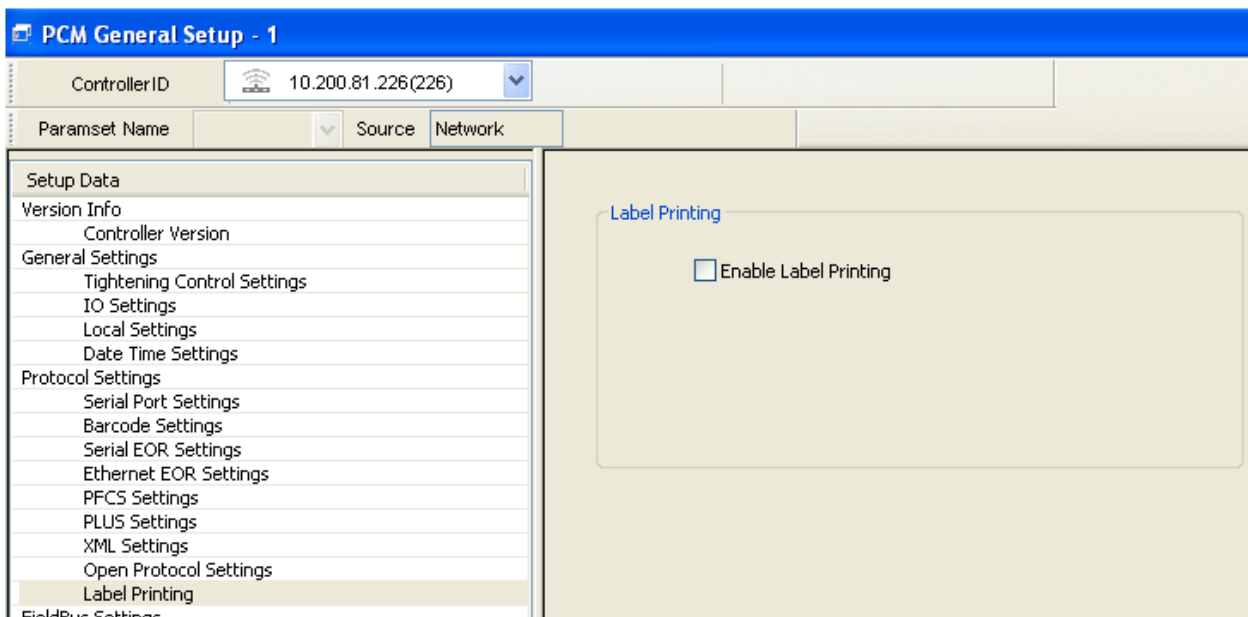

The IC-PCM 1:1 will have settings for Header, Data and Footer information that will be printed on the label. There are two things that must be present in the IC-PCM 1:1 in order to use the label printer feature.

- **status.txt** (printer communications is defined in this text)
- **body.txt** (The label format is defined in this text)

NOTE: At a time only one Protocol (Barcode/VIN, Serial EOR Data Out, PFCS, PLUS, Label Printing) can be enabled on the serial port.

3.2.3.15 Printer Connections and Setup for IC-PCM 1:1

- The IC-PCM 1:1 supports serial printers for printing EOR (End of Run) data.
- Connect the printer via a standard 9-pin serial cable to a serial port of the IC-PCM 1:1.
- Using ICS application, program the IC-PCM 1:1 serial port settings to match settings on the serial printer.
- Enable the Label Printing Protocol for the IC-PCM 1:1
- Make sure the necessary files are saved in the IC-PCM 1:1 for printing Header/ Data/ Footer sections. For more information, refer IC-PCM 1:1 General Setup manual.
- Turn on the printer.
- Run a tightening cycle and verify that tightening result is being printed.

3.2.4 FieldBus Settings

3.2.4.1 ProfiBus Settings

Profibus is an industrial fieldbus used primarily for I/O and controls. The IC-PCM 1:1 can come equipped with this slave card. The IC-PCM 1:1 can be controlled via this device as well as provide end of run status and torque and angle results.

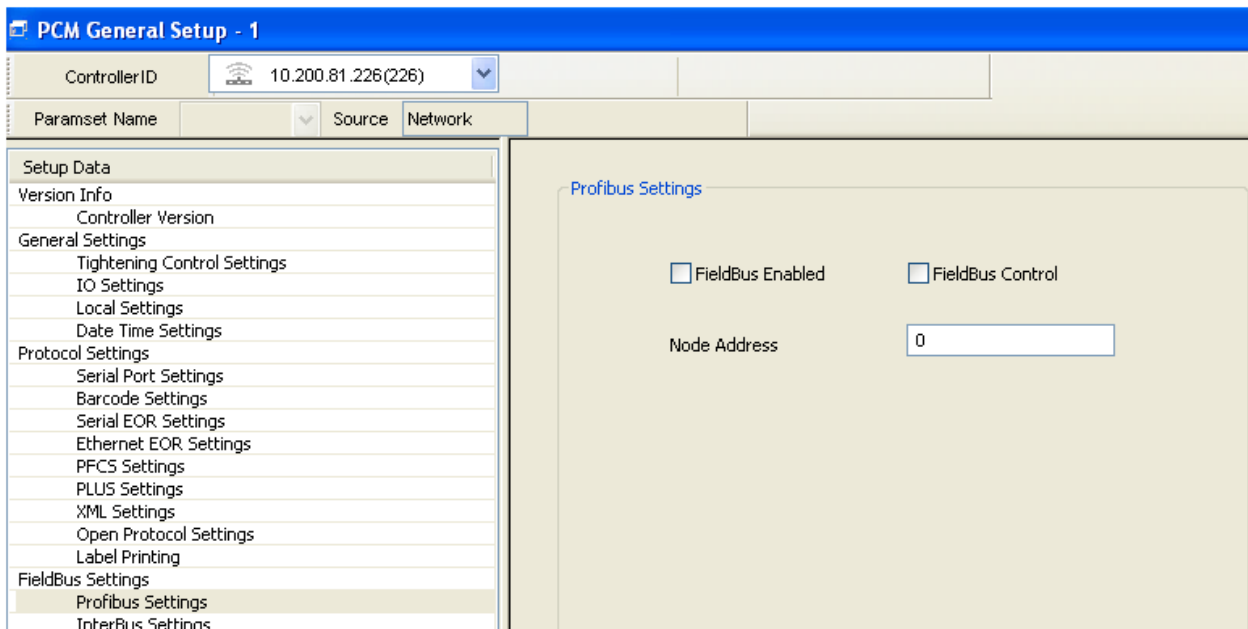

Field Bus Enabled	This enables fieldbus operations for IC-PCM 1:1.
	Output signals will be sent to the fieldbus master.
Field Bus Control	This enables control of the IC-PCM 1:1 by allowing the fieldbus master to set I/O.
Node Address	Each IC-PCM 1:1 on the fieldbus network needs to have a unique address.

3.2.4.2 InterBus Settings

InterBus is an industrial fieldbus used primarily for I/O and controls. The IC-PCM 1:1 can come equipped with this slave card. The IC-PCM 1:1 can be controlled via this device as well as provide end of run status and torque and angle results.

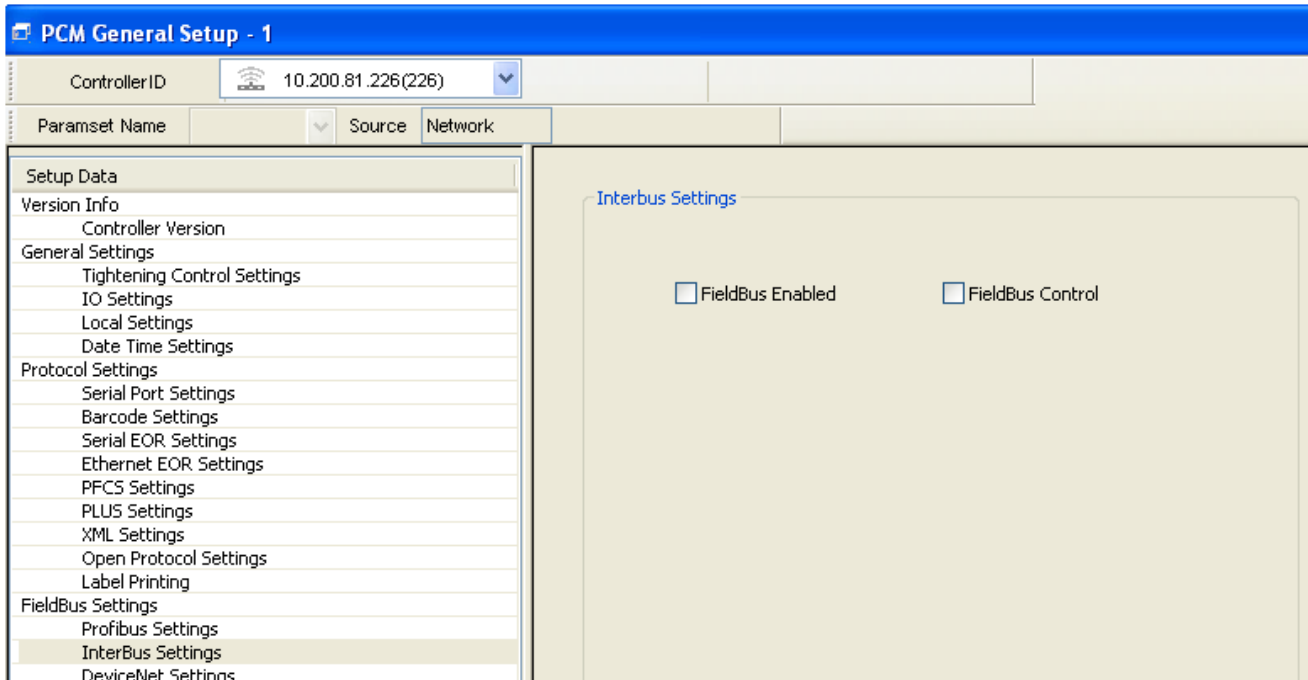

Field Bus Enabled	This enables the fieldbus operations for IC-PCM 1:1
	Output signals will be sent to the fieldbus master
Field Bus Control	This enables control of the IC-PCM 1:1 by allowing the fieldbus master to set I/O.

3.2.4.3 Devicenet Settings

DeviceNet is an industrial fieldbus used primarily for I/O and controls. The IC-PCM 1:1 can come equipped with this slave card. The IC-PCM 1:1 can be controlled via this device as well as provide end of run status and torque and angle results.

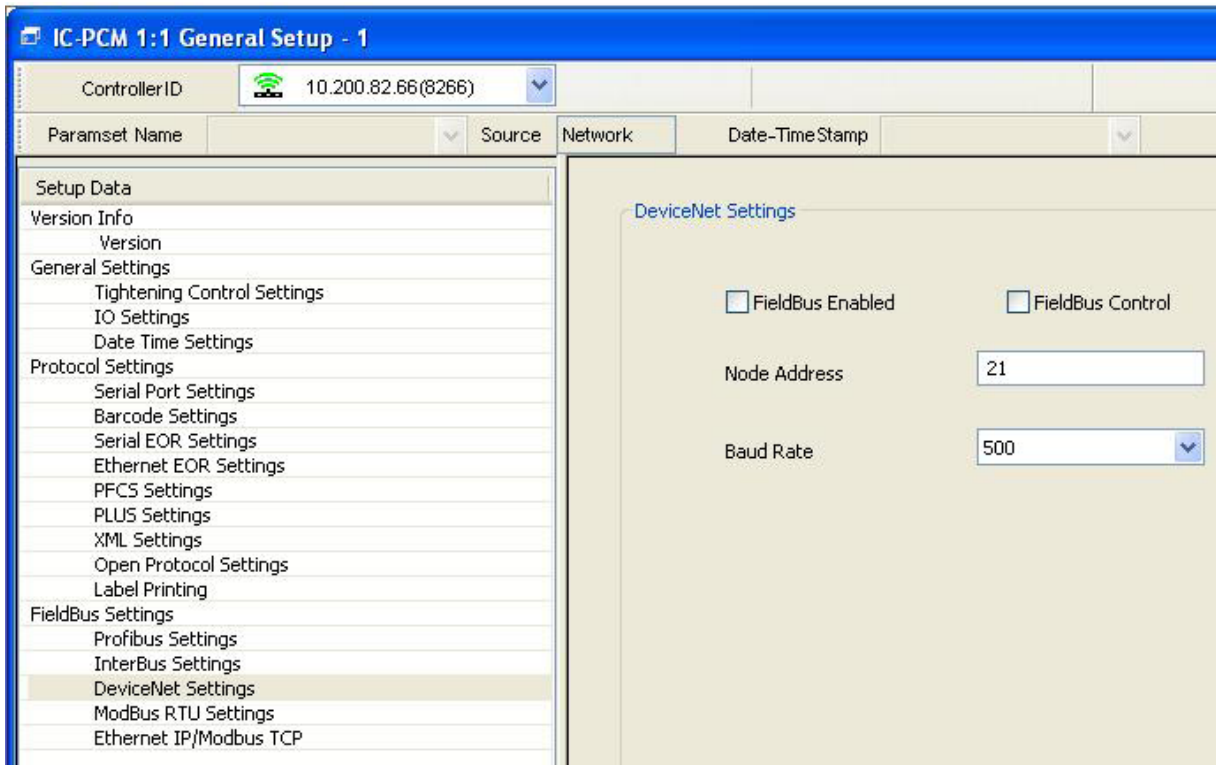

Field Bus Enabled	This enables the fieldbus operations for IC-PCM 1:1.
	Output signals will be sent to the fieldbus master
Field Bus Control	This enables control of the IC-PCM 1:1 by allowing the fieldbus master to set I/O.

Node Address	Each IC-PCM 1:1 on Fieldbus network needs to have a unique address.
Baud Rate	This is the DeviceNet communication speed. Following are baud rate which can be used - 110, 1200, 2400, 4800, 9600, 14400, 19200, 28800, 38400, 57600, 76800, 115200.

3.2.4.4 Modbus RTU Settings

ModBus RTU is an industrial fieldbus used primarily for I/O and controls. The IC-PCM 1:1 can come equipped with this slave card. The IC-PCM 1:1 can be controlled via this device as well as provide end of run status and torque and angle results.

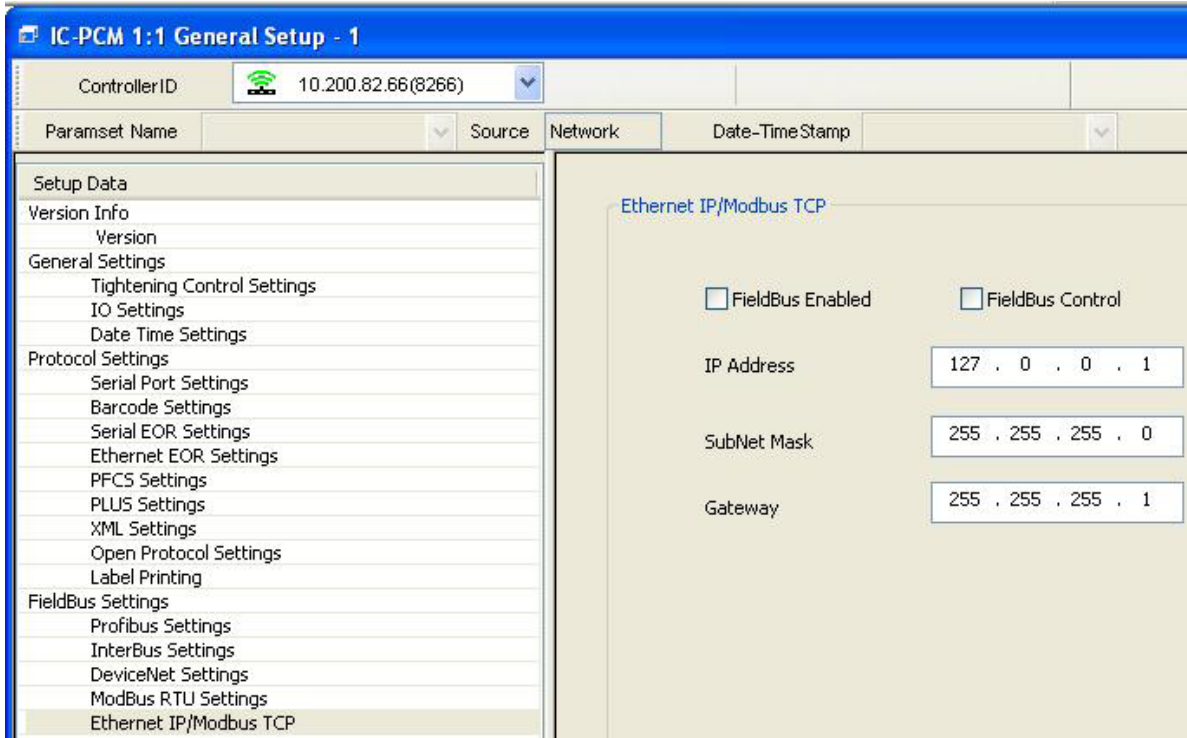

Field Bus Enabled	This enables the fieldbus operations for the IC-PCM 1:1 Output signals will be sent to the fieldbus master
Field Bus Control	This enables control of the IC-PCM 1:1 by allowing the fieldbus master to set I/O.
Node Address	Each IC-PCM 1:1 on the fieldbus network needs to have a unique address.
Baud Rate	This is the ModBus RTU communication speed. Following are the baud rate which can be used- 110, 1200, 2400, 4800, 9600, 14400, 19200, 28800, 38400, 57600, 76800, and 115200.
Parity	Select the Parity for the serial connection to None, Odd, or Even from the drop box list.

3.2.4.5 Modbus TCP/IP/Ethernet IP Settings

ModBus TCP/IP and Ethernet IP are industrial fieldbus used primarily for I/O and controls. The IC-PCM 1:1 can come equipped with this slave card. The IC-PCM 1:1 can be controlled via this device as well as provide end of run status and torque and angle results.

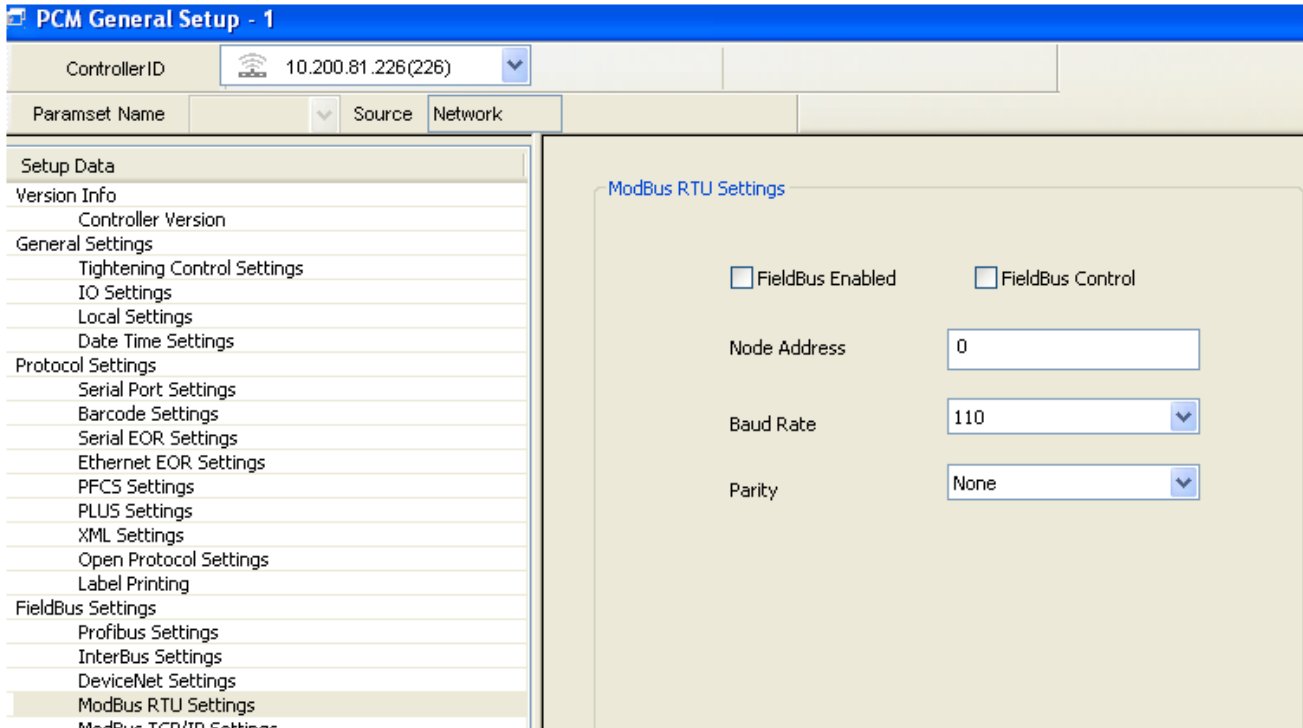

Field Bus Enabled	This enables the fieldbus for IC-PCM 1:1 Output signals will be sent to the fieldbus master.
Field Bus Control	This enables control of the IC-PCM 1:1 by allowing the fieldbus master to set I/O.
IP Address	Enter the IP Address of the ModeBus TCP/IP fieldbus device in a computer network.
Subnet Mask	A range of logical addresses within the address space that is assigned to an organization
Gateway	Gateway is a node on a computer network that serves as an access point to another network

3.3 Parameter Assignment

The Parameter Assignment Screen allows the user to assign any saved Configuration and/or General Parameter set to the tool connected to USB and IC-PCM.

This screen also allows the user to edit the General Parameter settings of the IC-PCM 1:1 or Send a saved General Parameter Set to the IC-PCM 1:1.

This screen works in the network mode only. The left side of the screen shows all the devices (IC-PCM 10:1 and assigned (mapped) tools, IC-PCM 1:1 and mapped tools, and tools connected to USB) connected to the network.

Expanding a IC-PCM 1:1 node will display the "General Params" node and a node for the mapped tool. Expanding the tool Location ID node will display the "General Params" node and the "Configs" node for the mapped tool. Expanding the "Config" node will display a node for each of the 8 allowable Configurations.



Expanding a IC-PCM 10:1 node will display all the tools mapped to the IC-PCM 10:1. Expanding each tool Location ID node will display the "General Params" node and the "Configs" node. Expanding the "Config" node will display a node for each of the 8 allowable Configurations.

Expanding the USB Direct Tool will display the "General Params" node and the "Configs" node. Expanding the "Config" node will display a node for each of the 8 allowable Configurations.

The upper right half of the screen displays a list of General Parameter Sets for IC-PCM 1:1 stored in the Local Database that can be sent to a IC-PCM 1:1. The lower right half shows the available General Parameter Sets stored in the Local Database that can be sent a tool.

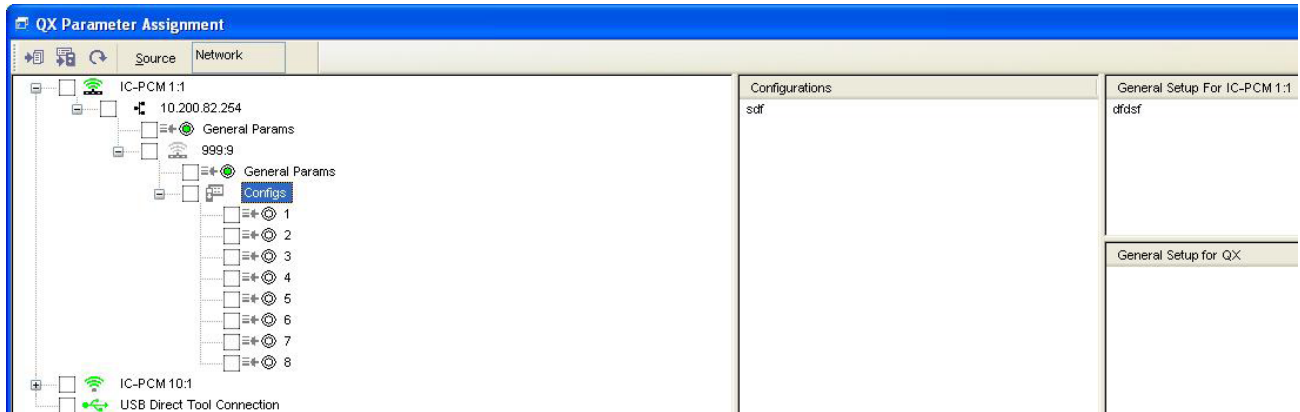
The middle section of the screen displays the Configuration Sets stored in the Local Database that can be sent to a tool.



	Button used to send Configurations to a tool that is connected to USB or IC-PCM.
	Button used to send General Parameters to a IC-PCM 1:1 or to a tool.
	Button used to refresh the screen.
Source Network	Field indicates type of mode, which is always Network for this screen.

The stored General Parameters can be assigned to the “General Params” node of any IC-PCM 1:1 or tool by a simple drag-and-drop operation. Similarly, Configuration Sets can be assigned to any “Configuration number” node of a tool by drag-and-drop operation.

The color conventions for “General Params” nodes and “Configuration Number” nodes are as follows:

Green indicates that General Parameters and Configuration Parameters are already programmed and have not been modified.

Yellow indicates that the General Parameters or Configuration Sets are currently programmed, but have been updated, either by a Drag-and-Drop operation or by double clicking on the set and making changes.

Red indicates that the Configuration Set was initially not programmed, but a Configuration Set has been assigned by a Drag-and-Drop operation.

White indicates that the Configuration Set is not programmed.

General Parameters or Configuration Sets can be viewed by double clicking on the corresponding node.

Double clicking on the “Configuration Number” node opens the Tightening Configuration Setup screen which can then be viewed and/or edited. Double clicking on the “General Params” node of a tool opens the Tool General Setup screen which can then be viewed and/or edited. Double clicking on an IC-PCM 1:1 General Setup node opens the IC-PCM 1:1 General Setup screen which can then be viewed and/or edited.









From the Parameter Assignment screen, Configurations can also be unassigned from any tool. For any programmed Configuration, right click on the “Configuration Number” node. A float box with an “Unassign Config” option will be created. Selecting this option removes the Configuration from the tool.

3.4 Wireless Tool Settings

This screen provides the ability to view all the IC-PCMs available in the network and also provides the connection status of the tools mapped to each IC-PCM.

If a tool logs-in successfully, this screen displays the current versions of display, MCE, and radio firmware as well as device type icons changed to represent the tool type.

All connected IC-PCMs will have a row entry in this screen which displays Job id, IP address, Ethernet MAC address, RISC Version, Radio versions of both primary and secondary radio modules, and Primary and Secondary radio MAC addresses.

Device Type	Job ID	IP Address	Ethernet Mac	RISC Version	Primary Radio Version	Secondary Radio Version	Primary Radio MAC	Secondary Radio MAC	Location ID	Display Version	MCE Version
	1111	10.200.82.33	00:02:31:FF:FF:04	16.D.1.0.0.0	0.0.101.00	0.0.101.00	00:00:00:09:00:00:00:01	00:00:00:09:00:00:00:02	010:0	0.0.0.0	0.0.0.0
									010:1	0.0.0.0	0.0.0.0
									010:2	0.0.0.0	0.0.0.0
									010:3	0.0.0.0	0.0.0.0
									010:4	0.0.0.0	0.0.0.0
									010:5	0.0.0.0	0.0.0.0
									010:6	0.0.0.0	0.0.0.0
									010:7	0.0.0.0	0.0.0.0
									010:8	2.0.4.72	1.0.4.80
									010:9	0.0.0.0	0.0.0.0

Following table gives brief description of each field available in screen.

Device Type	This field indicates type of tool.
Job ID	Job ID of the IC-PCM. Job ID is a four-digit entry that represents location identification on assembly line. Each IC-PCM must have a unique number for identification on network.
IP Address	IP Address of the IC-PCM
Ethernet Mac	Mac Address of the IC-PCM
RISC Version	Displays current IC-PCM RISC version
Primary Radio Version	Displays the current version of the primary radio firmware.
Secondary Radio Version	Displays the current version of the secondary radio firmware.
Primary Radio MAC	Displays the MAC address of the primary radio module.
Secondary Radio MAC	Displays the MAC address of the secondary radio module.
Location ID	Location Id of the tool. Each tool must have a unique number for identification.
Display Version	Current Tool Display version
MCE Version	Current Motor control version
Wireless version	Current Tool Radio version

3.4.1 IC-PCM Settings

User can edit the IC-PCM network settings. To change/view the settings double click on respective IC-PCM on Wireless settings.

Sync Time button is used to set the current system Date & Time to IC-PCM.

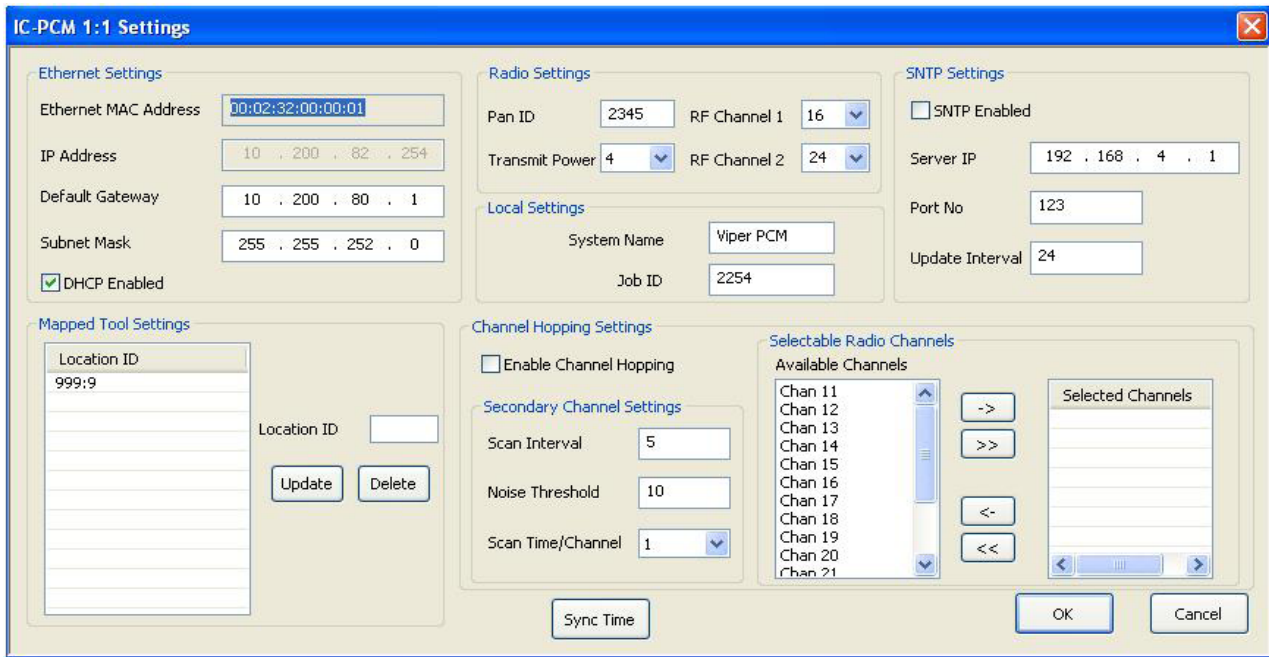

This IC-PCM Settings dialog box has the following Settings.

1. Ethernet Settings
2. Radio Settings
3. SNTP Settings (Applicable only for IC-PCM 1:1)
4. Channel Hopping Settings
5. Mapped Tool Settings
6. Selectable Radio Channels
7. Local settings

3.4.1.1 Ethernet Settings

This section has the Network Settings. User can edit/view the following controls under Ethernet Setting group.

Ethernet MAC Address	Network Mac ID of IC-PCM, which is read only.
IP Address	IP Address of the IC-PCM. If DHCP is disabled then the user can set the IP Address.
Default Gateway	Gateway is a node on a computer network that serves as an access point to another network.
Subnet Mask	A range of logical addresses within the address space that is assigned to an organization.

DHCP (Dynamic Host Configuration Protocol)	If DHCP is enabled the IC-PCM acquires the IP Address dynamically from the Network. If DHCP is disabled then the user has to enter the IP Address manually. It should be unique across the system.
---	---

NOTE: The changes of Ethernet settings require reboot of IC-PCM and changes takes place only after the reboot has completed .

3.4.2 Radio Settings

The Radio setting used to set the settings of the Radio Module for establishing the wireless communication between IC-PCM and the mapped tool.

Pan ID	The 5 digit number which is used to uniquely define a PAN (Personal Area Network) number. Based on PAN ID, devices choose the radio network for communication.
RF Channel 1	Primary Radio channel is responsible for all communication. The set of available channels are from 11 to 25.
RF Channel 2	Secondary Radio channel scans energy levels of the available channels. This is to keep track of the best available channels for communication with the tool. If channel hopping is enabled, communication switches to the best available channel.
Transmit Power	Allows to select the transmit power level up to 4 dBm based on radio environment. NOTE: For Channels 11 and 12, only transmit power levels of 0 and 1 are available.

NOTE: The IC-PCM Radio settings must match with the Tool Radio Settings to establish the communication with the tool.

3.4.3 SNTP Settings

The SNTP settings are applicable only for IC-PCM 1:1.

Enabled	Allows the time to be set via an SNTP server.
Server IP	SNTP Server IP Address.
Port No	SNTP Server port number
Update Interval	Time interval to update the local time from the SNTP server.

NOTE: The changes of SNTP settings require reboot of IC-PCM 1:1 and changes takes place only after the IC-PCM 1:1 reboots.

3.4.4. Channel Hopping Settings

The Radio settings allow establishing the wireless communication between IC-PCM and the mapped tool.

Enable	Enables the channel hopping feature
---------------	-------------------------------------

3.4.4.1 Secondary Channel Settings

These settings are specific to secondary radio channel.

Scan Interval	The interval, the secondary channels starts scanning of the energy levels of the channel. This interval is in minutes.
Noise Threshold	Threshold Noise %, where secondary channel will switch.
Scan Time per channel	Time to scan each channel

3.4.4.2 Selectable Radio Channels

User can select set of channels from the Available Channels list. User can select one channel or all channels from Available Channel list.

3.4.4.3 Mapped Tool Settings

User can Add, Edit or Delete the tool location id to the tool map of the IC-PCM.

The tool must be mapped to the IC-PCM 1:1 in order for any communications to take place. Only one tool can be mapped to IC-PCM 1:1. Only one tool can be mapped to IC-PCM 1:1.

Any change in the IC-PCM 1:1 tool map requires clearing the cycle log of the IC-PCM 1:1 for data consistency. If the tool map is modified the IC-PCM 1:1 prompts the user with the Clear Cycle Log request. The tool map change request will be sent only upon clearing the IC-PCM 1:1 cycle log data.

For the IC-PCM 10:1, a maximum of 10 tools can be mapped.

3.4.4.4 Local Settings

This allows the user to assign/view the system name and location id to the IC-PCM.

3.5 Download Software

The Download Software screen allows the user to download “Display”, “MCE”, and “Wireless Radio” firmware to the tool connected via USB. This screen can also be used to download PCM “RISC” software and PCM “Wireless Radio” firmware to a selected IC-PCM.

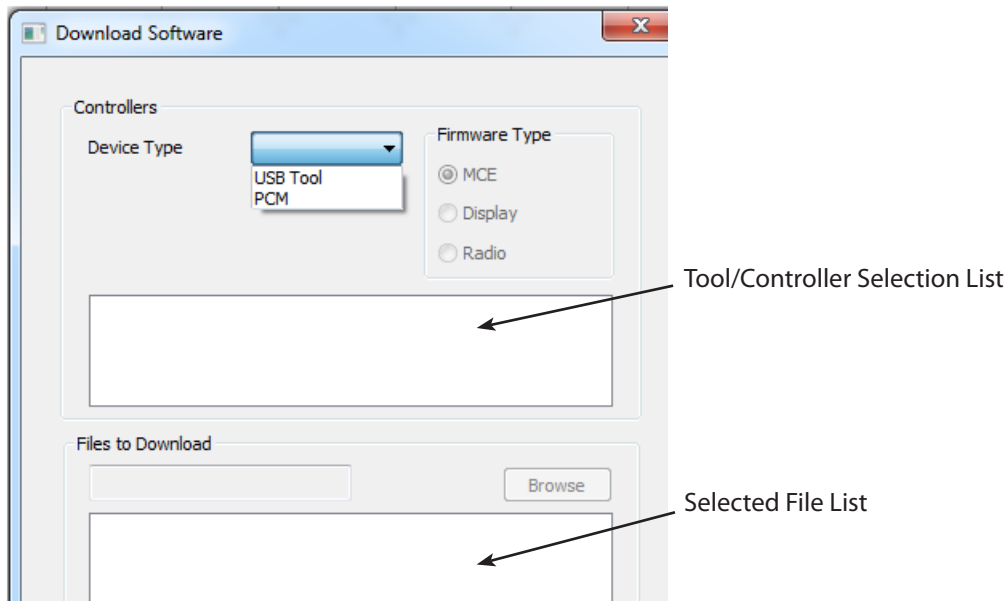

Device Type Drop Box	Select the type of device for the download operation such as USB/ IC-PCM. The device of the selected type presently on the network is displayed in the Tool/ IC-PCM Selection List below.
Tool/Controller Selection List	Select the Tool/IC-PCM for download operation by checking in the associated check box.
Browse Button	Opens a file browser dialog to select the file to be downloaded. Choose the RISC/Radio firmware for IC-PCM or MCE/Display/Radio firmware files for the tool connected to USB.
Files to Download	File selected from File Browser Dialog is displayed.
Selected File List	File selected to be downloaded is displayed.
Start Button	Starts downloading upon user confirmation.
Close Button	Closes the Download Software screen.
Clear IC-PCM Data	Clears the setup and data files on the selected IC-PCM. The IC-PCM must be rebooted after this operation.

3.5.1 Download firmware Procedure for the Tool Connected to USB

3.5.1.1 MCE Firmware

This Firmware runs on the Motor Controller Electronics (MCE) module of the tool.

1. Select the device type as “USB Tool” from the dropdown list and select the Firmware Type as “MCE”.
2. Select the tool location ID check box.

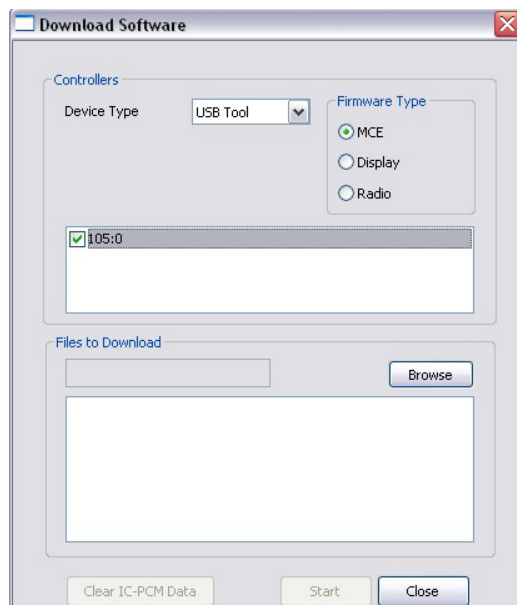

3. Browse to the file “qx_mce.out” to download the MCE firmware.

NOTE: By default all the Firmware files can be found in the ICS install path\Others folder.
An Error Message will prompt the user in case of an Invalid File selection.

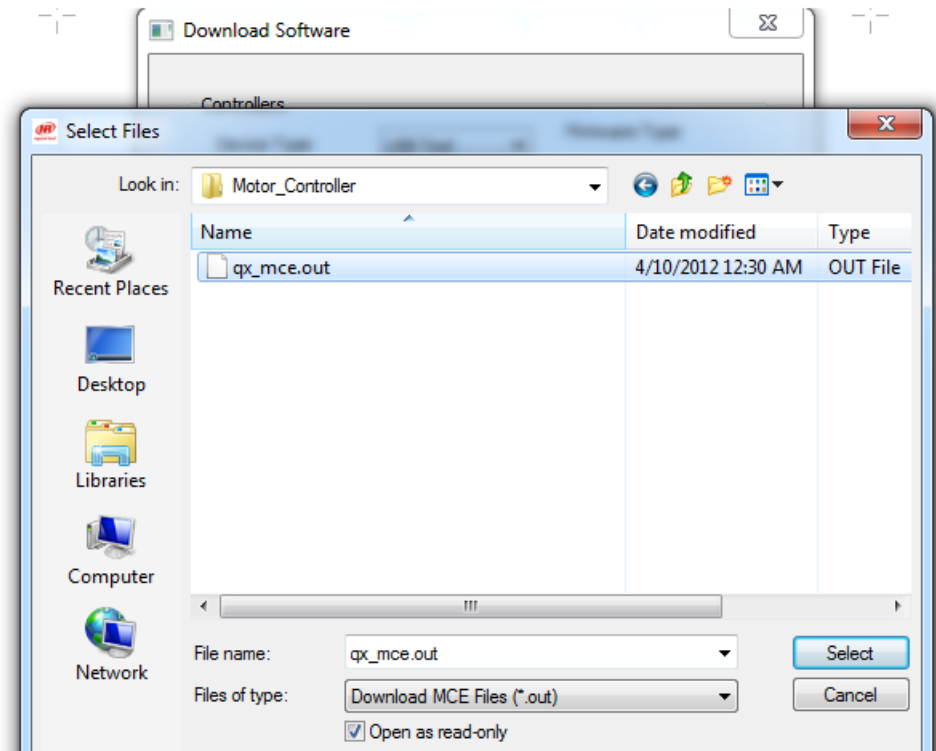

4. Click on the start button to start the MCE firmware downloading process to the tool. A message will prompt the user for confirmation.

5. Click on the Yes button of the message box.

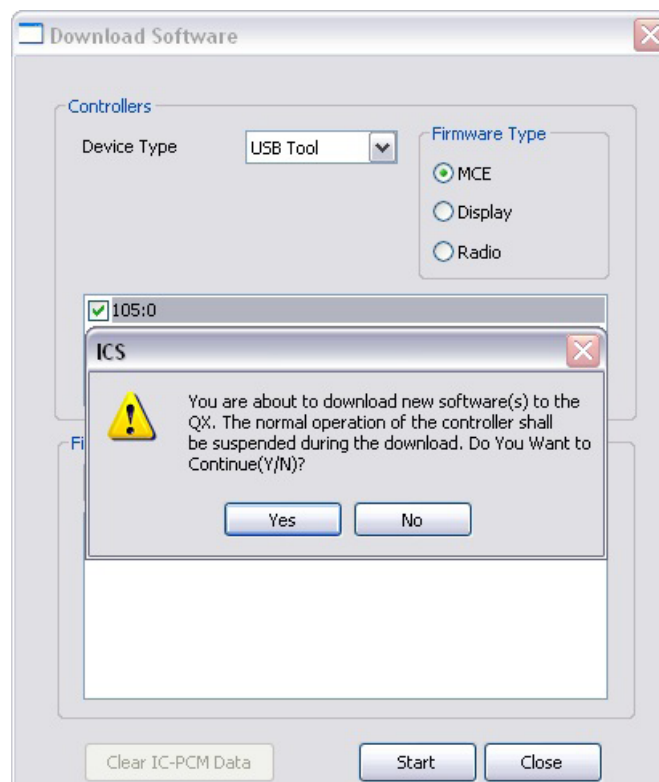

6. At the end of the download process, ICS prompts with "Tool Wake up" Message.

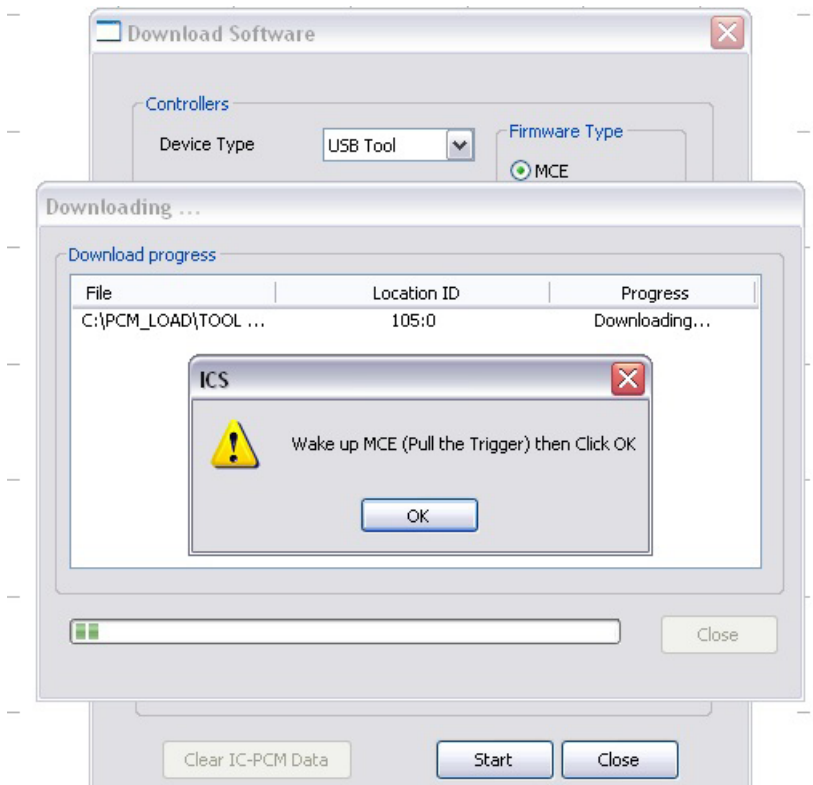

7. Wake up the tool (pull the trigger) and then click on the OK button of the message box to complete the download process.
- NOTE:** Waking up the tool is essential because the MCE can go into sleep mode during the firmware download, it is required that the MCE be in an active state to complete the download process.

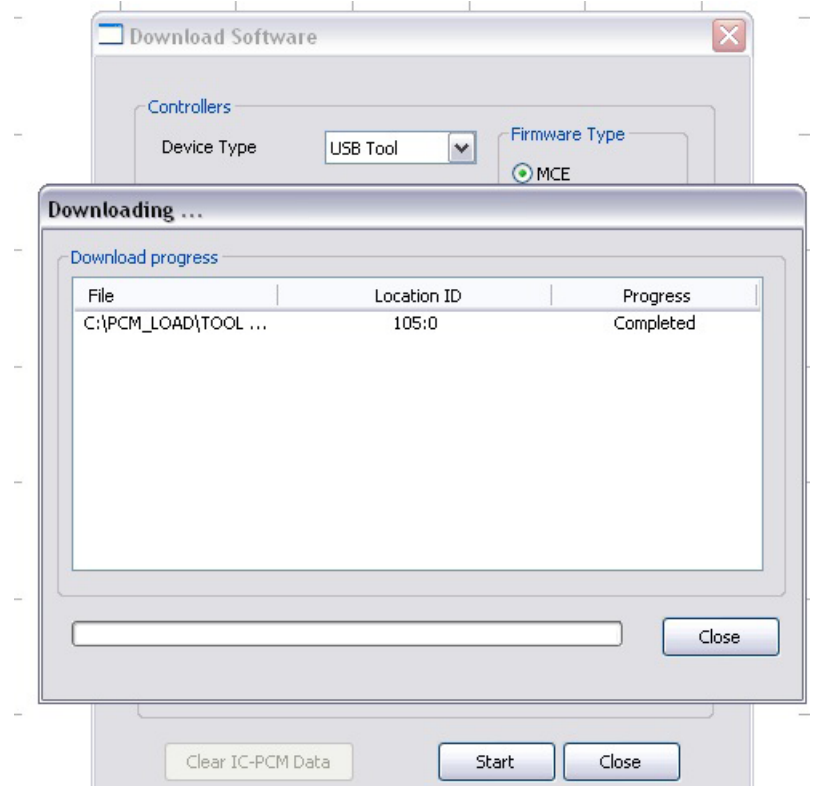

8. The tool reboots immediately after sending the "Wake up" message. The Display will show the **Ingersoll Rand** logo and the LEDs will blink for 2 – 3 minutes until it has completed the internal loading process.
9. Restart the tool after the tool reboots successfully. The uploaded MCE version can be viewed on the wireless setting screen once ICS has successfully logged into the tool.

3.5.1.2 Display Firmware

This Firmware runs on the display module of the tool

1. Select the device type as “USB Tool” from the dropdown list and select the Firmware Type as “Display”.

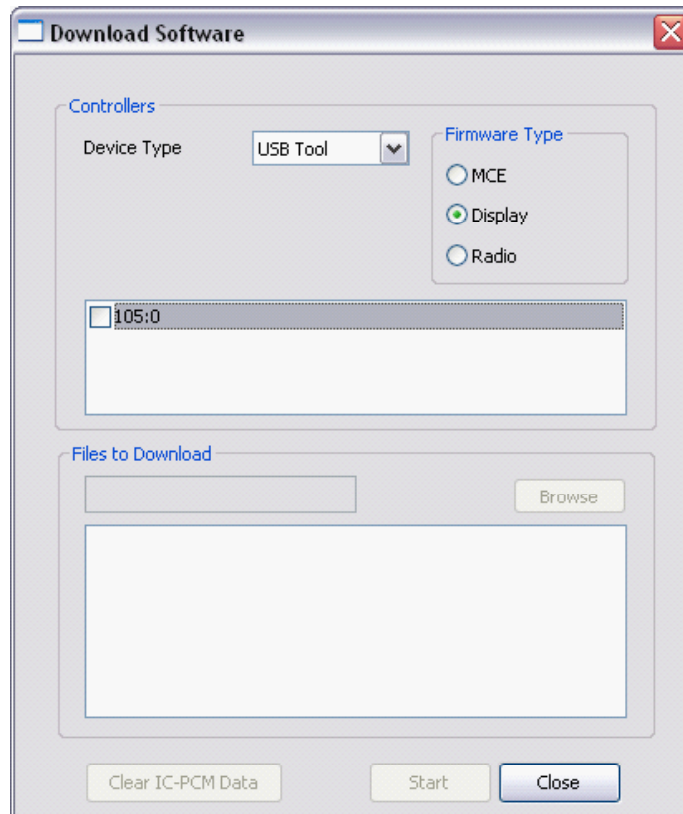

2. Select the tool location ID check box.

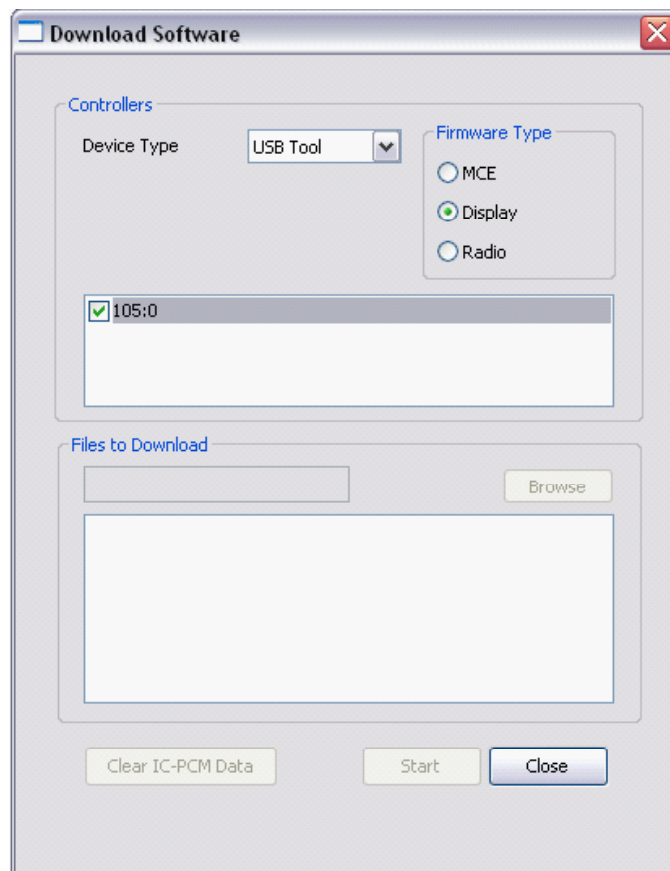

- Browse to the file "qx_display.hex" to download the Display firmware.
NOTE: By default all the Firmware files can be found in the ICS install path\Others folder.
 An Error Message will prompt the user in case of an Invalid File selection.

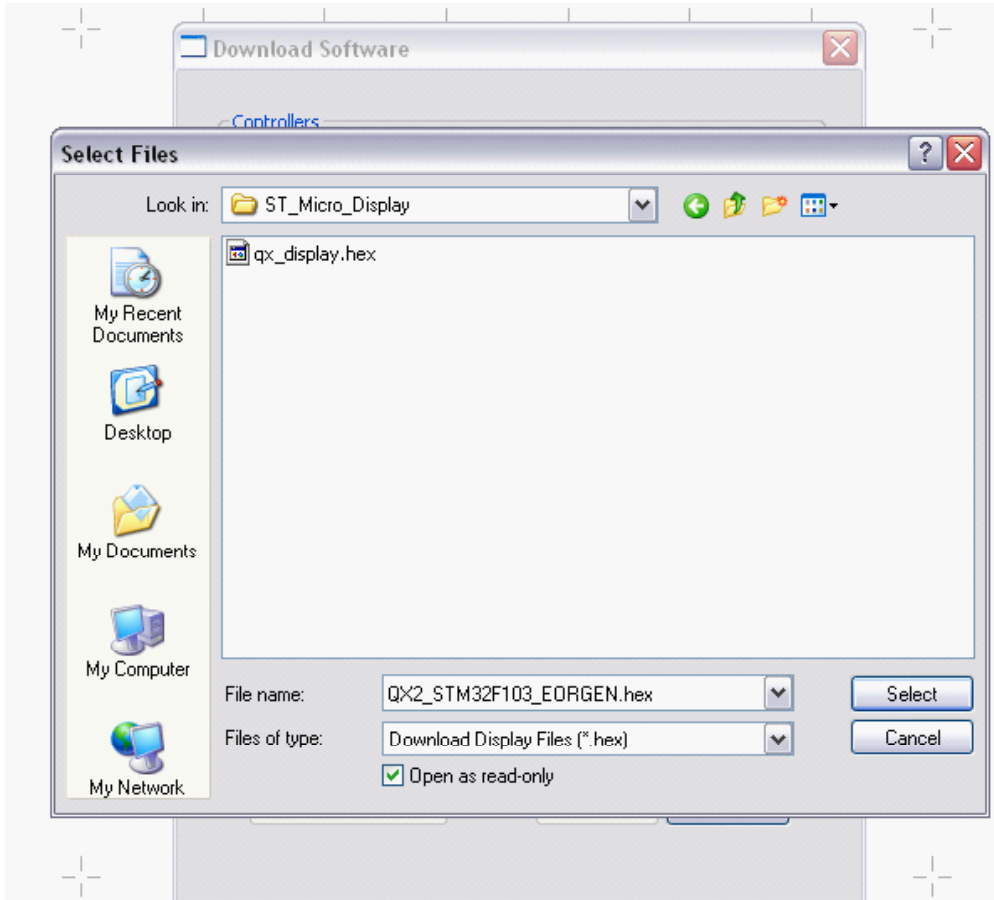

- Click on the start button to start the Display firmware downloading process to the tool. A message will prompt the user for confirmation.
- Click on the Yes button of the message box.

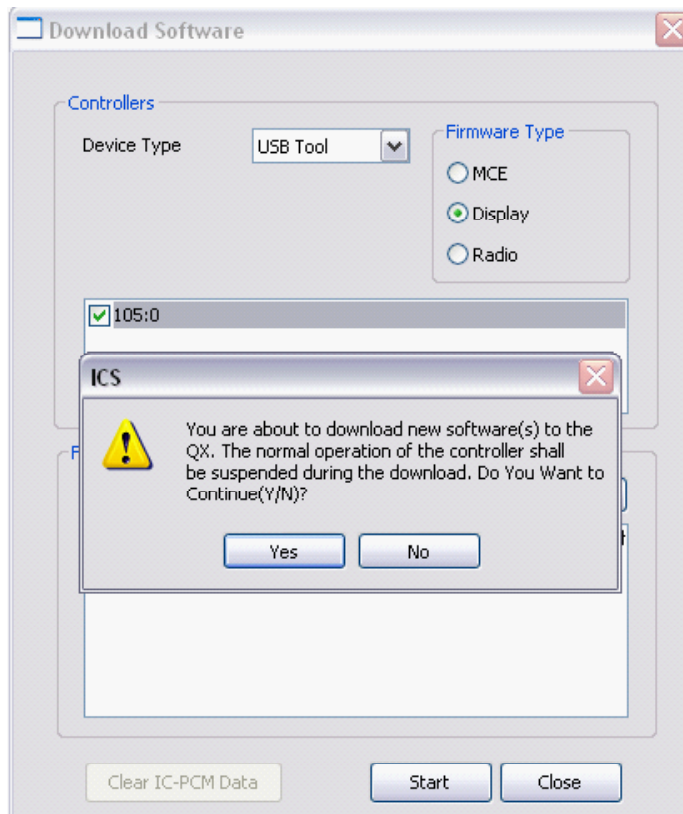

6. The tool display will automatically reboot after the downloading process is completed. The Display will then show the **Ingersoll Rand** logo until it has completed the internal loading process. Once the internal loading process is complete for the display, the display will again reset automatically.

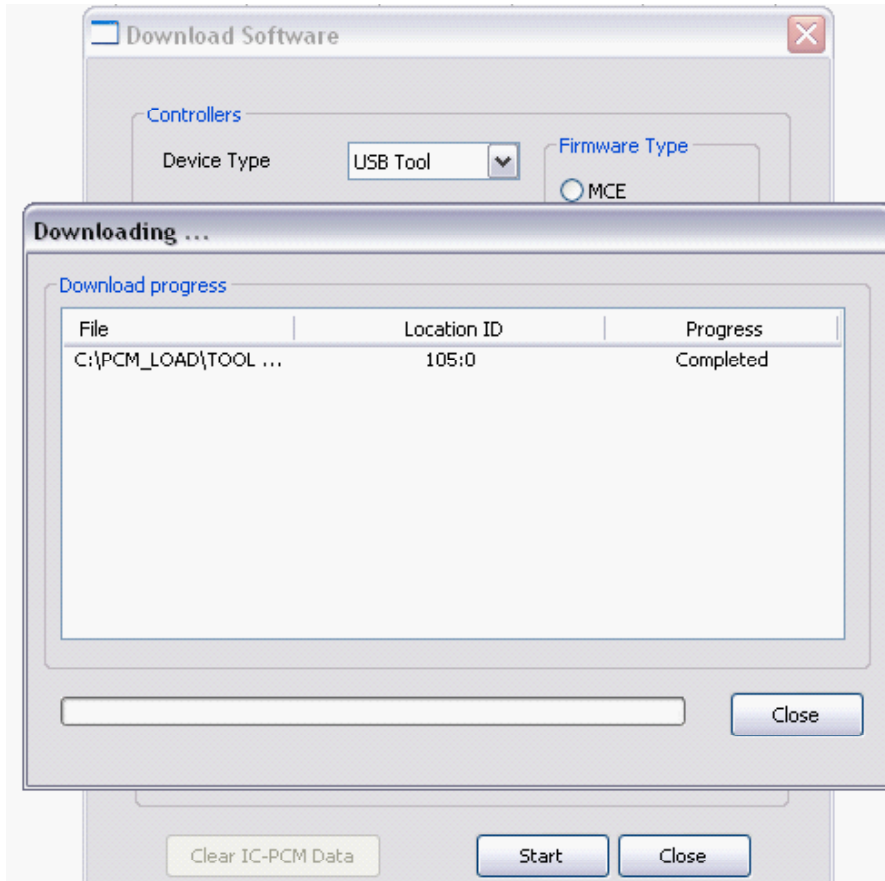

7. Restart the tool after it resets successfully. The uploaded Display version can be viewed on the wireless setting screen once ICS has successfully logged into the tool.

3.5.1.3 Radio Firmware

This Firmware runs on the Wireless Radio Board of the tool.

1. Select the device type as "USB Tool" from the dropdown list and select the Firmware Type as "Radio".

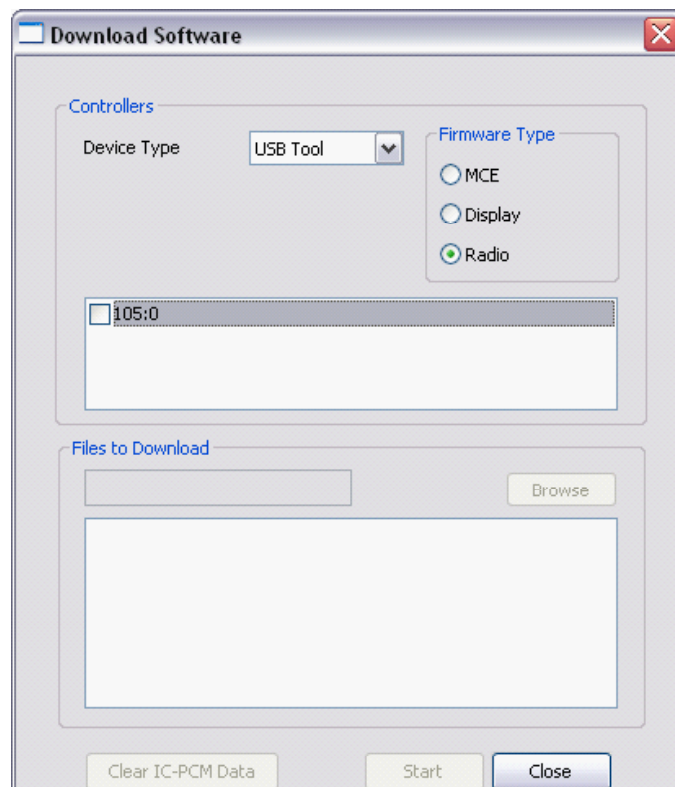

2. Select the tool location ID check box.

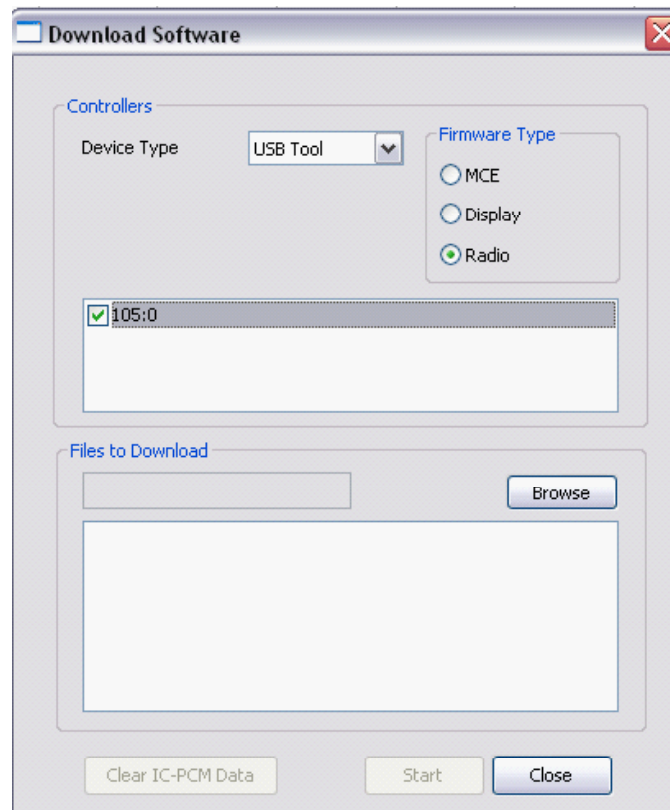

3. Browse to the file "qx_wireless.hex" to download the Radio firmware.
NOTE: By default all the Firmware files can be found in the ICS install path\Others folder.
An Error Message will prompt the user in case of an Invalid File selection.

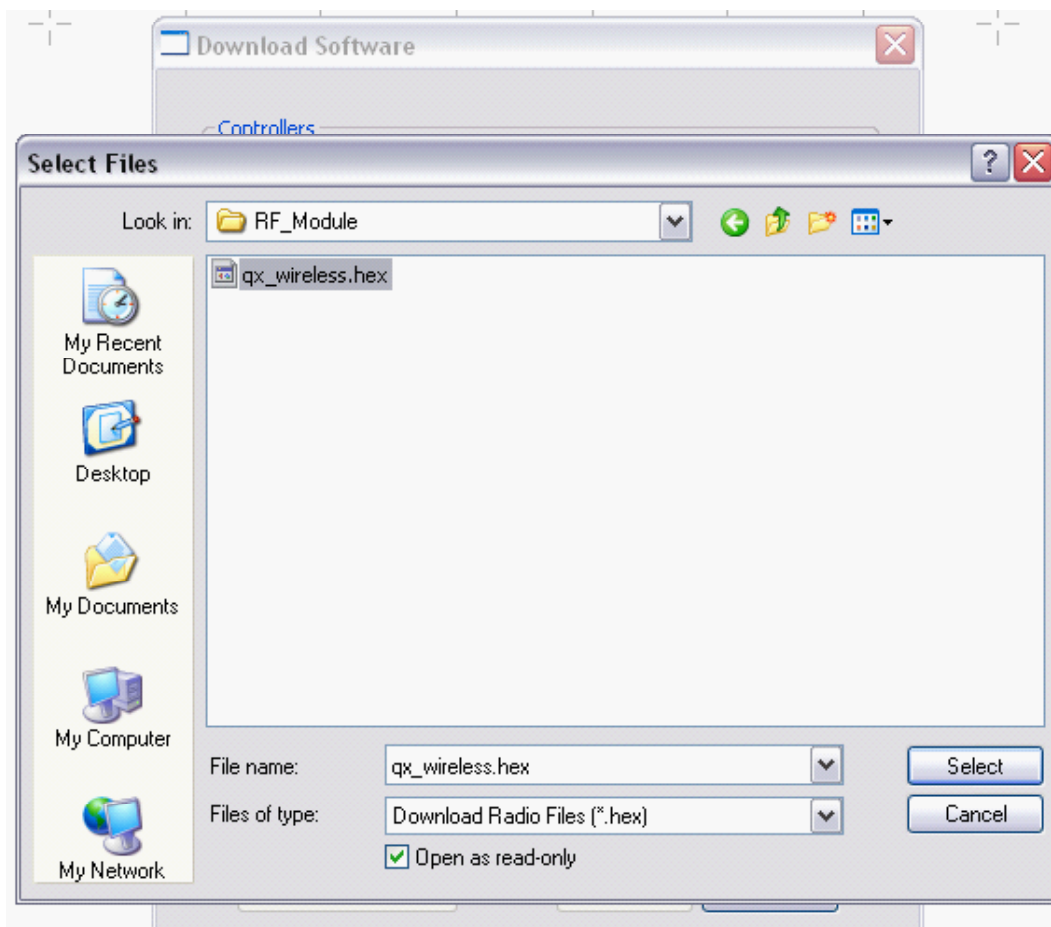

4. Click on start button to start the Radio firmware downloading process to tool. A message will prompt the user for confirmation.

5. Click on the Yes button of message box.

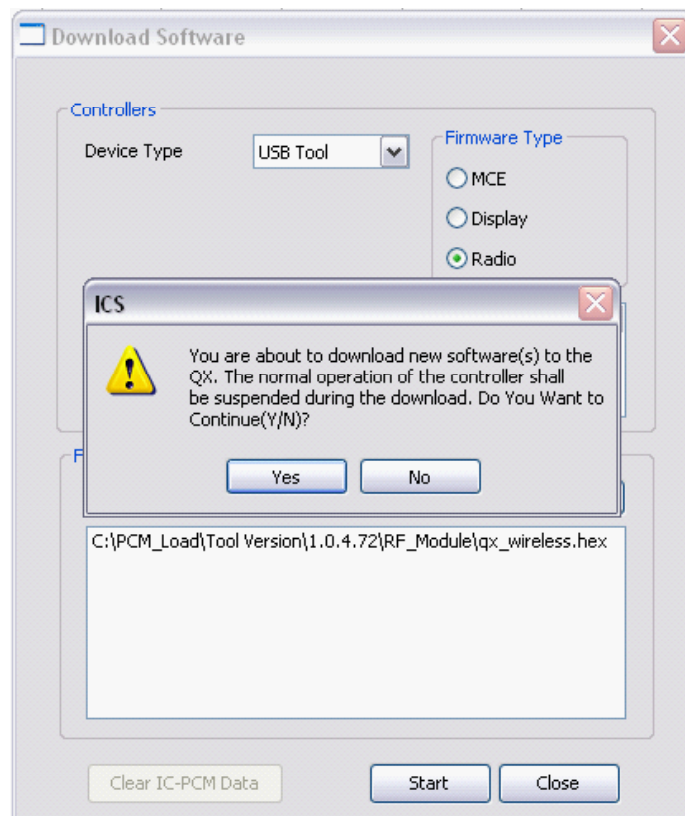

6. After downloading is completed, tool reboots automatically.
The Display will go blank and the LEDs will blink. This process will happen for approximately 3 - 5 minutes until it has completed the internal loading process. Once the internal loading process is complete for the radio board, the display will again reboot automatically.

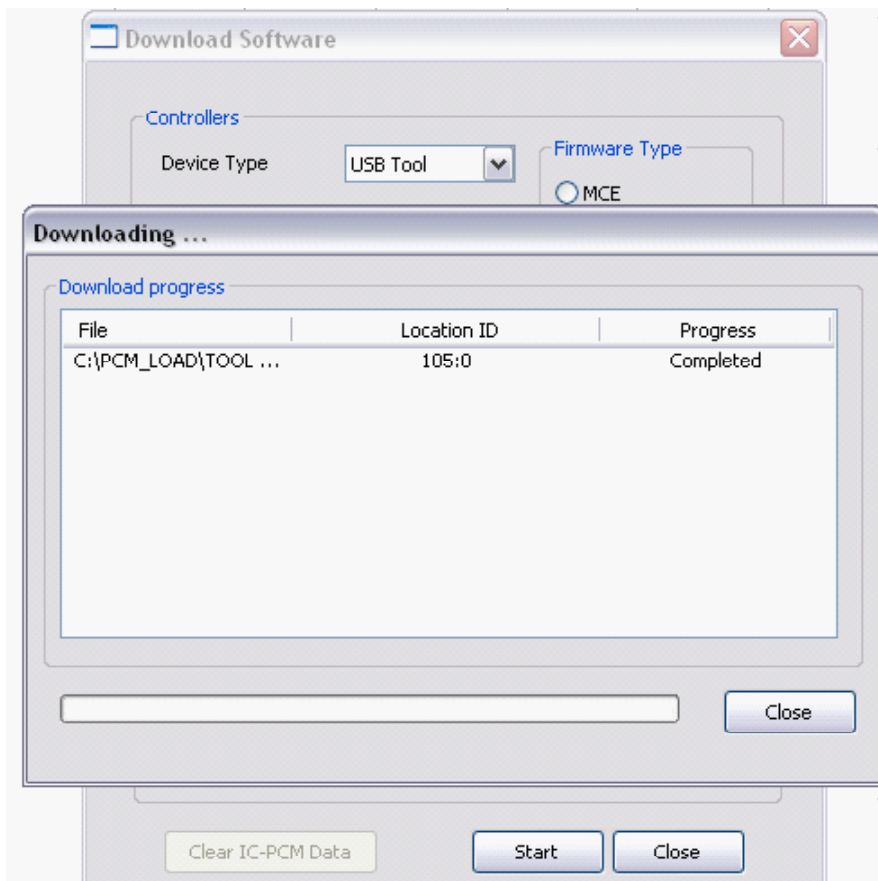

7. Restart the tool after it reboots. The uploaded Radio Firmware version can be viewed on the wireless setting screen once ICS has successfully logged into the tool.

3.5.2 Download firmware procedure for a IC-PCM on the Network

3.5.2.1 RISC Firmware

This Firmware runs on the RISC Board of the IC-PCM.

1. Select the device type as "IC-PCM" from dropdown list and select Firmware Type as "RISC".
2. Select the IP check box.

NOTE: User can also select multiple IP Addresses for RISC software download.

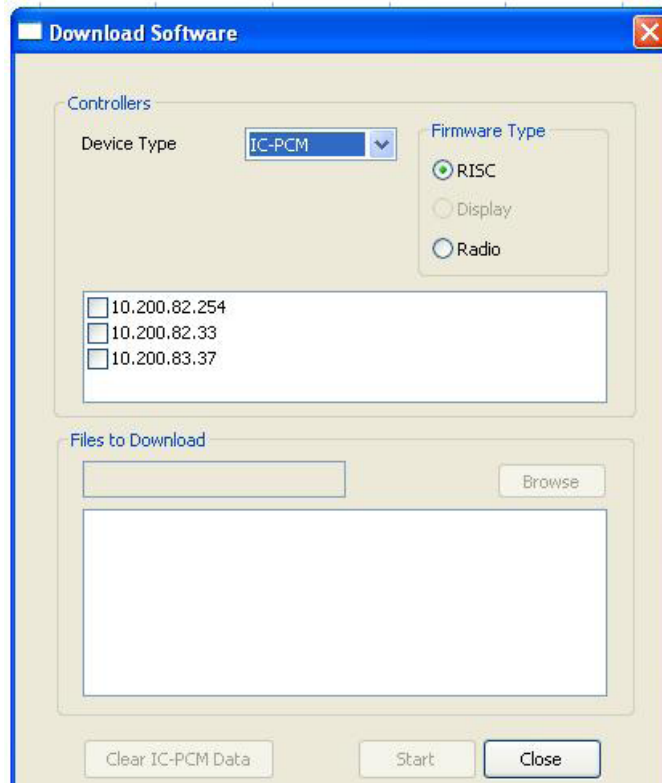

3. Browse to file "qx_risc.irb" to download the RISC firmware.

NOTE: By default all the Firmware files can be found in the ICS install path\Others folder. An Error Message will prompt the user in case of an Invalid File selection.

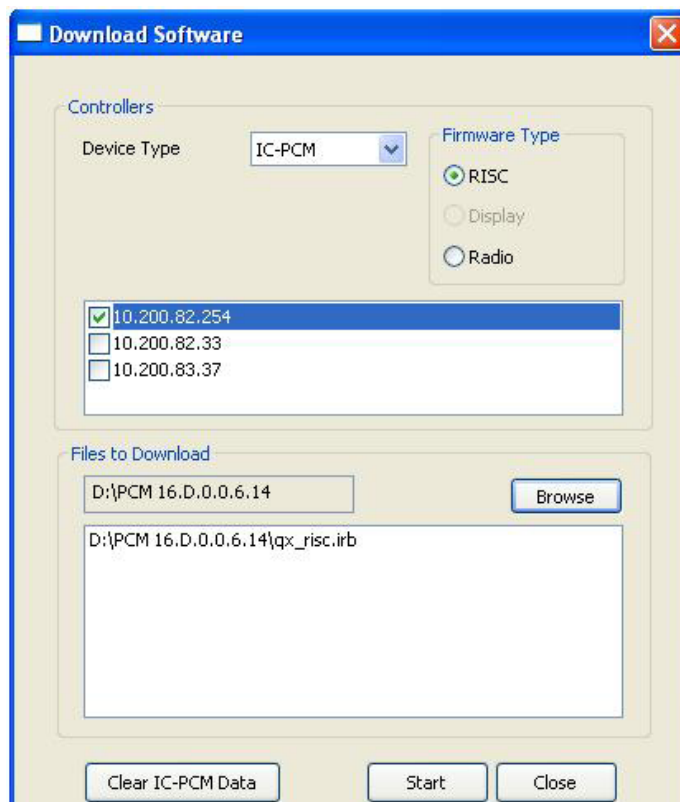

4. Click on the start button to start the RISC firmware downloading process to the controller.
A message will prompt the user for confirmation.
5. Click on the Yes button of the message box.

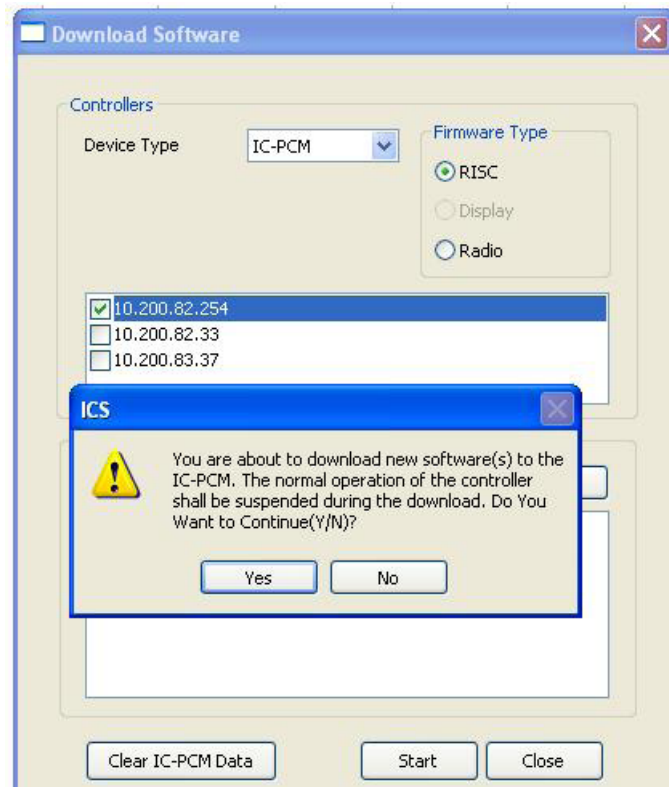

6. After the downloading is completed, the IC-PCM automatically reboots.
NOTE: If the IC-PCM does not reboot automatically after 10-15 minutes, reboot manually.

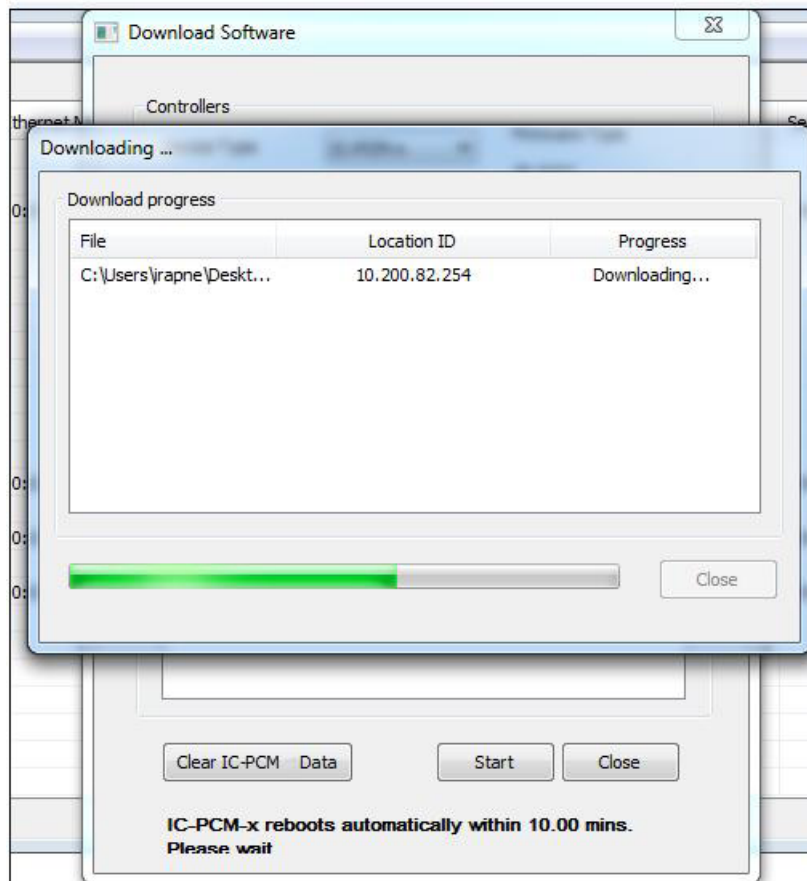

7. Once IC-PCM successfully reboots and is logged into ICS, the version of RISC firmware can be viewed on wireless setting screen.

3.5.2.2 Radio Firmware

This Firmware runs on the Wireless Radio Board of the IC-PCM 1:1.

1. Select device type as "PCM" from the dropdown list and select Firmware Type as "Radio".

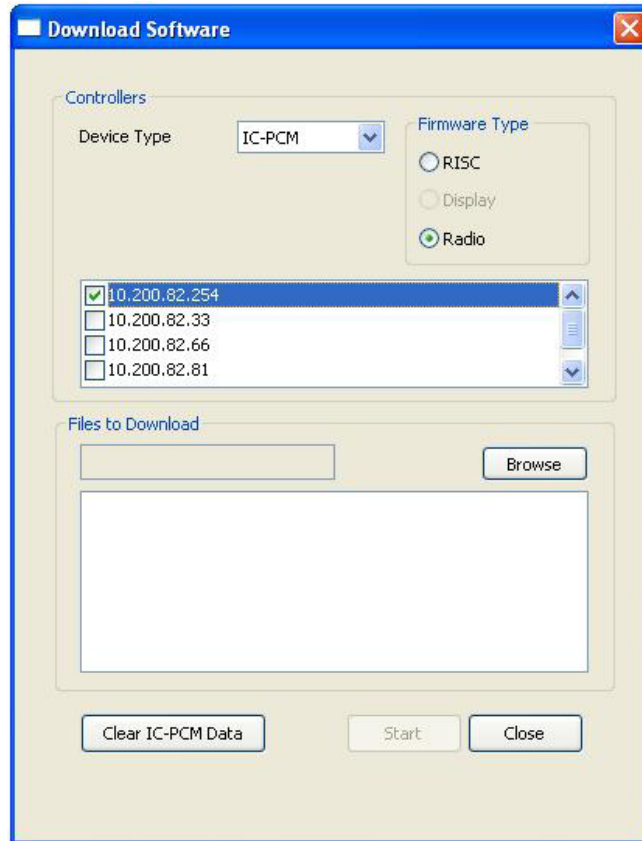

2. Select the PCM IP check box.
NOTE: User can also select multiple PCM IP Addresses for Radio software download.
3. Browse to the file "qx_wireless.bin" to download Radio firmware.
NOTE: By default all the Firmware files can be found in ICS install path\Others folder.
An Error Message will prompt the user in case of an Invalid File selection.

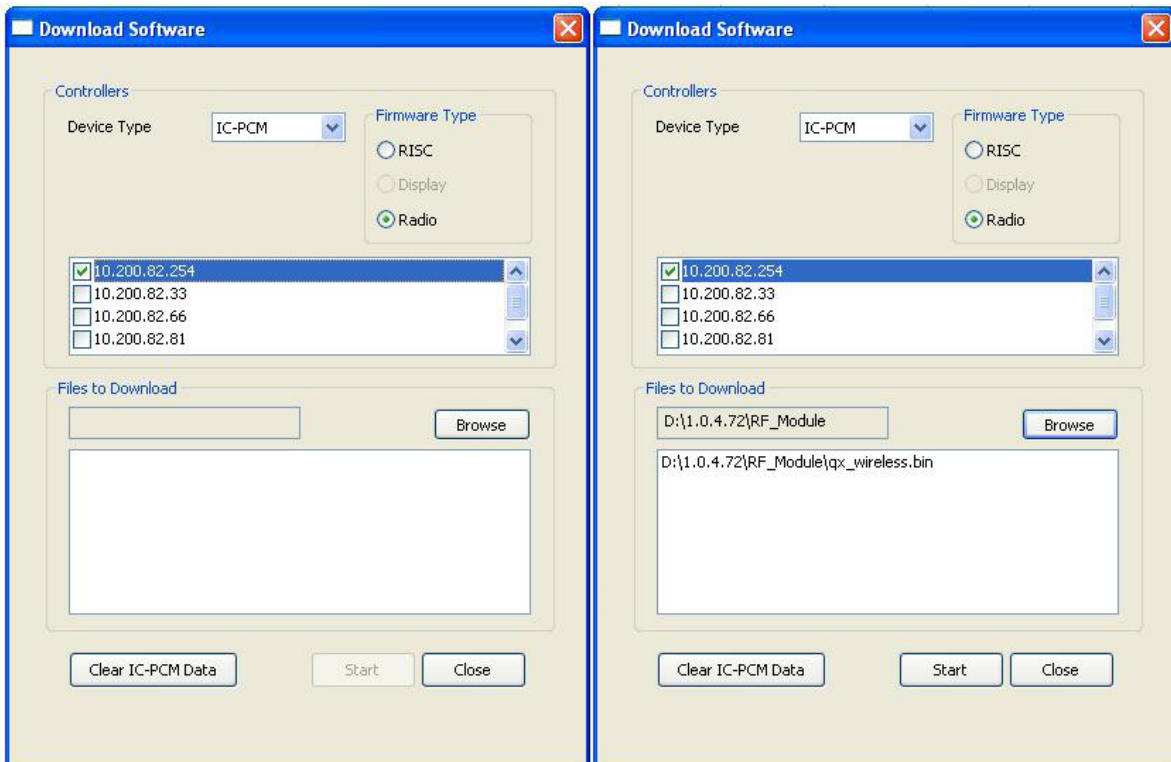

- Click on start button to start Radio firmware downloading process to the tool. A message will prompt user for confirmation.
- Click on Yes button of message box.

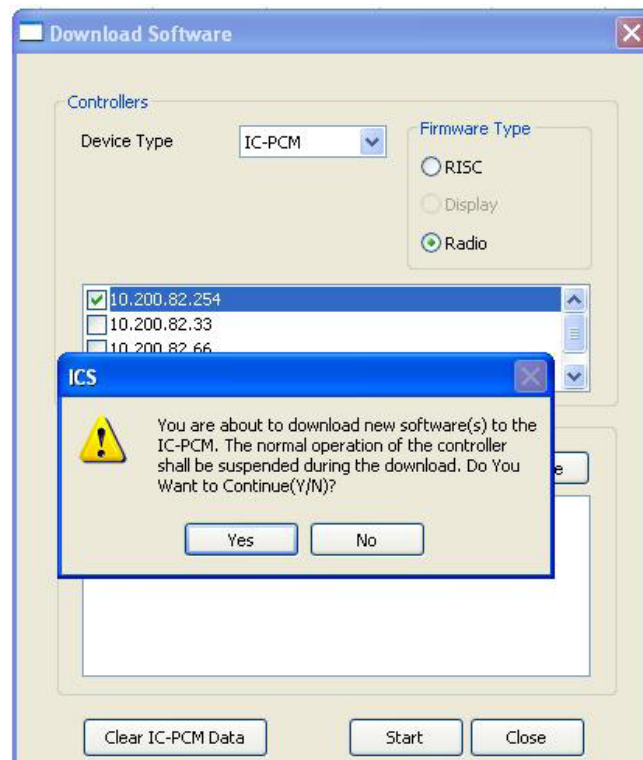

- After the downloading is completed, IC-PCM automatically reboots.
NOTE: Reboot IC-PCM manually if it does not reboot automatically.

3.5.2.3 Clear Data

Clears the selected IC-PCM data.

- Select the device type as IC-PCM from the dropdown and select a one or multiple IC-PCM.

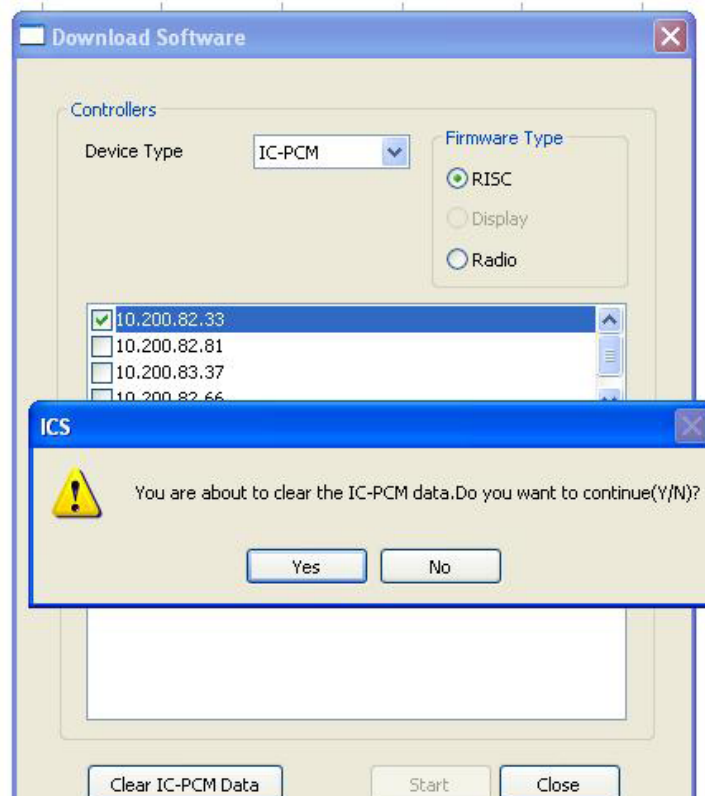

- Click on Clear Controller Data button. A message will prompt user for confirmation.

- Click on Yes button of message box.
- NOTE:** This clears all data including cycle logs, PCM settings, and tool map information.
- ICS prompts with a message "Please Reboot PCM after 30 secs: xxx.xxx.xxx.xxx", where xxx.xxx.xxx.xxx is PCM IP Address.
- Click on the OK button of the message box and reboot PCM after 30 seconds.

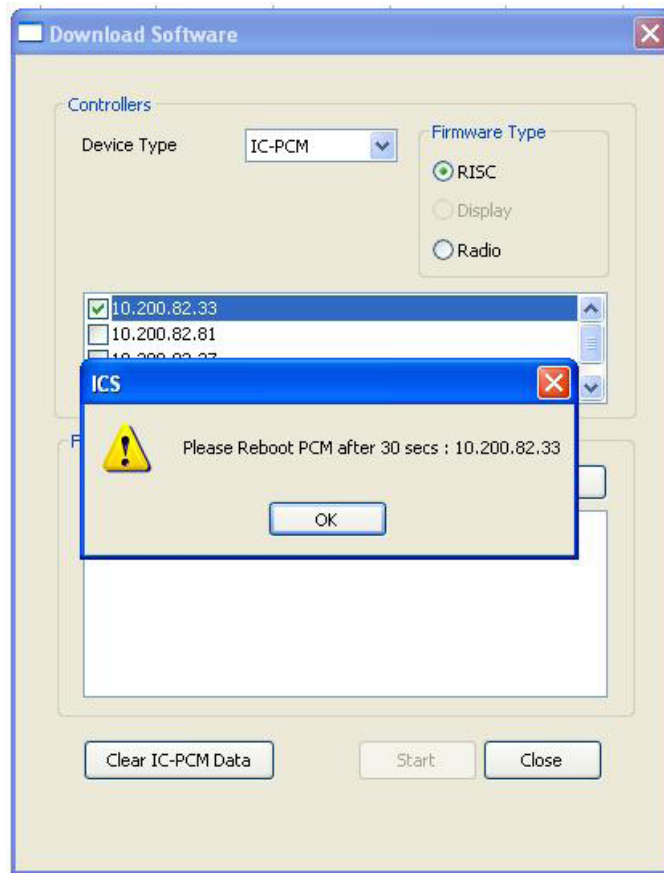

3.6 Reboot

The Reboot screen allows user to reboot the selected IC-PCM currently on network. Also, primary and secondary radio modules of the IC-PCM can be rebooted.

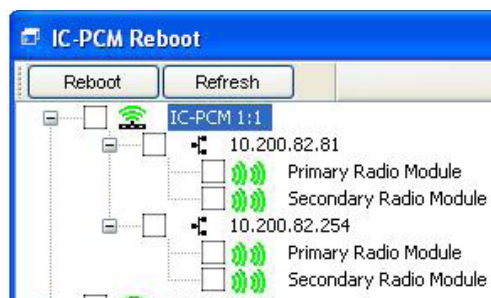

3.6.1 Reboot IC-PCM

- Expand the IC-PCM.
- Select required IP addresses that needs to be rebooted and then click on 'Reboot' button.

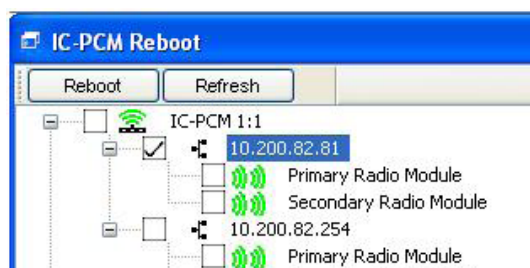

3. A reboot message is sent to the selected IP addressed which reboots the device(s).
4. The controller(s) reboot(s).

3.6.2 Reboot Radio Modules

1. Expand required IP addresses for which reboot radio command need to be sent.
2. Select primary or secondary or both (primary and secondary) radio modules and click on reboot button.
3. A reboot message is sent to reboot the radio modules.

NOTE: This does not reboot entire system and any wireless transaction will happen only after successful reboot of radio module.

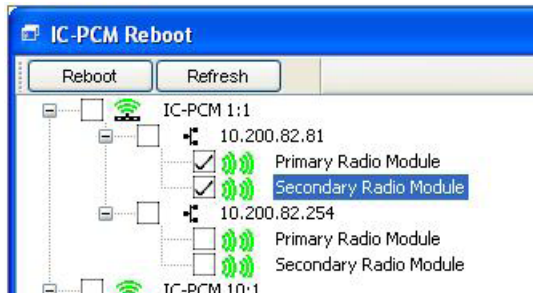

IC-PCM 1:1	Displays the list of IC-PCM 1:1 present on the network.
IC-PCM 10:1	Displays list of IC-PCM 10:1 present on network.
Reboot	Reboots the selected IC-PCM or radio modules that are checked in the associated check box.
Refresh	Refreshes and updates the list with latest IC-PCMs present on the network.

3.7 PCM Wireless Energy Detector

This screen can be used to view energy level in each RF channel. The energy level for each channel is displayed against their respective channel number starting from 11 to 25.

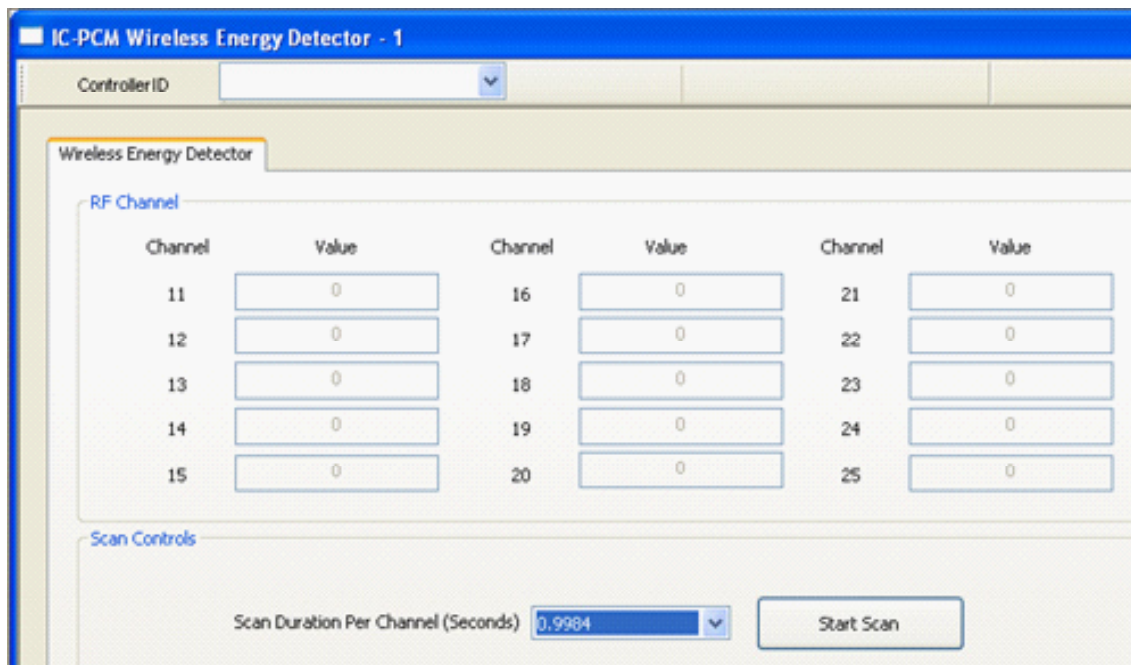

Initially when IC-PCM is selected from drop box last stored data will be displayed. To receive the current level of wireless energy click on "Start Scan" button with specific time required to scan each channel.

The drop box "Scan Duration per Channel (Seconds)" is the set to scan each channel. For example if the time is selected as 0.9984 then time required to complete the scan is given below.

$$0.9984 * 15 = 14.976 \text{ seconds.}$$

NOTE: Scanned energy value for a particular channel is proportional to the amount data being transferred in the channel.

Section 4 – Monitoring Cycle log and Event Log of IC-PCM 1:1/Tool

4.1 Run Main Cycle Log







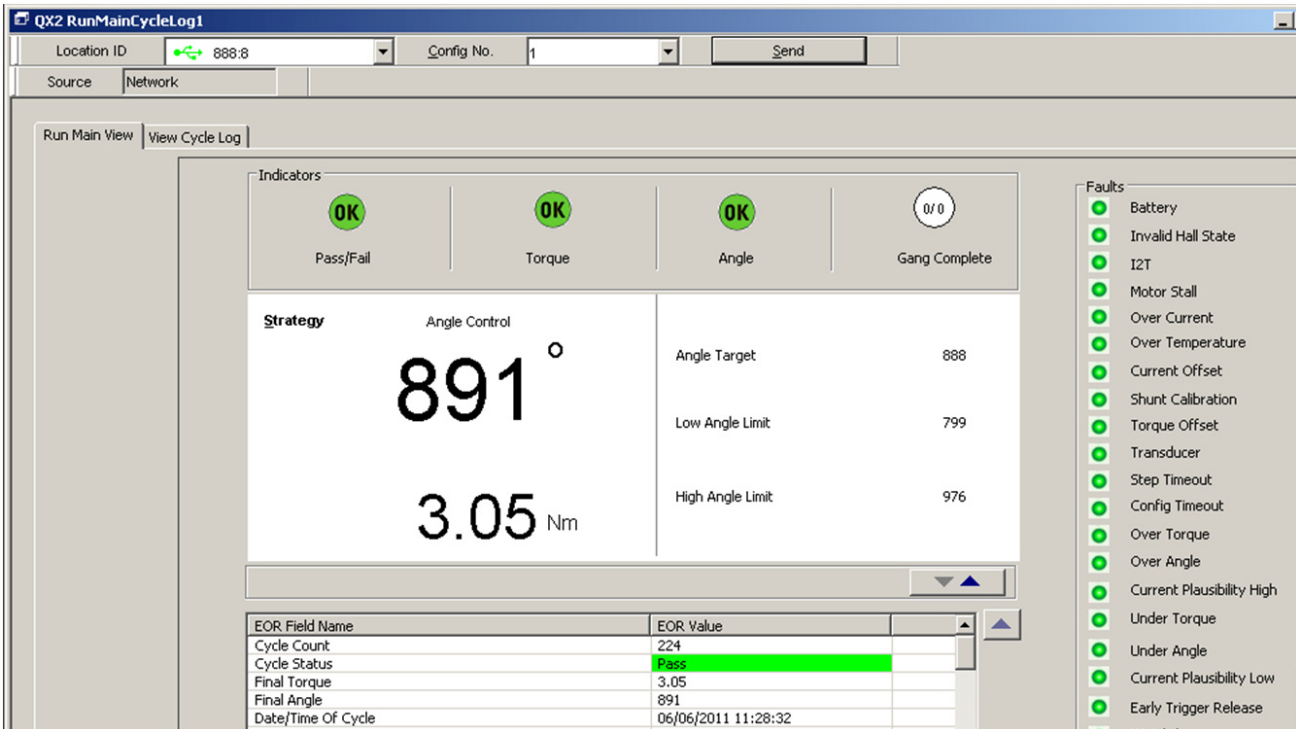

The Run Main Cycle Log window has two tabs, Run Main View and View Cycle Log.







4.1.1 Run Main View Tab

The Run Main View tab Displays EOR of the latest cycle for a selected tool.



The values shown on this screen include:

Location ID	This drop box is used to select the tool connected to USB / IC-PCM.
Config No	Displays configuration number of latest cycle and also allows selecting the desired configuration number of tool connected to USB.
Send Button	This button allows user to set desired configuration of tool connected to USB.
Pass / Fail Indicator	Displays an indicator for overall Pass/Fail status of tightening operation. The 'OK' image is shown if the operation passes; otherwise, the Failure image is shown. PASS  FAIL 
Torque status indicator	Displays an indicator for status of torque. The downward yellow arrow image indicates that torque is less than the torque low limit and the red upward arrow image indicates that torque is greater than or equal to torque high limit. If torque is between low torque and high torque limit, then an OK image is shown. Within Limits  High Limit  Low Limit 
Angle status indicator	Displays an indicator image for status of angle. The downward yellow arrow image indicates that angle is less than the angle low limit and the red upward arrow image indicates that angle is greater than or equal to the angle high limit. If angle is between low angle and high angle limit, then an OK image is shown. Within Limits  High Limit  Low Limit 

Gang complete indicator	The OK image is shown when 'Gang Complete' occurs. If the total gang count is 3 then for each pass cycle the screen shows (1/3, 2/3 and OK) as shown below. In case of fail cycles the gang count value in the screen remains same.
	  
Faults	Displays the Faults description of tightening data. NOTE: Green indicates particular fault did not occur, where as Red indicates the fault has occurred.
	  
EOR Field/ Value table	Displays the EOR fields and values at the end of the fastening. Clicking the up/down arrow below the main window, allows the user to hide/ show the EOR List.

4.1.2 View Cycle Log Tab

The View Cycle Log tab allows retrieving 1200 latest tightening records that are stored on tool which are connected to USB/ IC-PCM 10:1 and also allows retrieving 1200 latest tool tightening records that are stored on IC-PCM 1:1.

User can view data stored in archive DB and local DB.

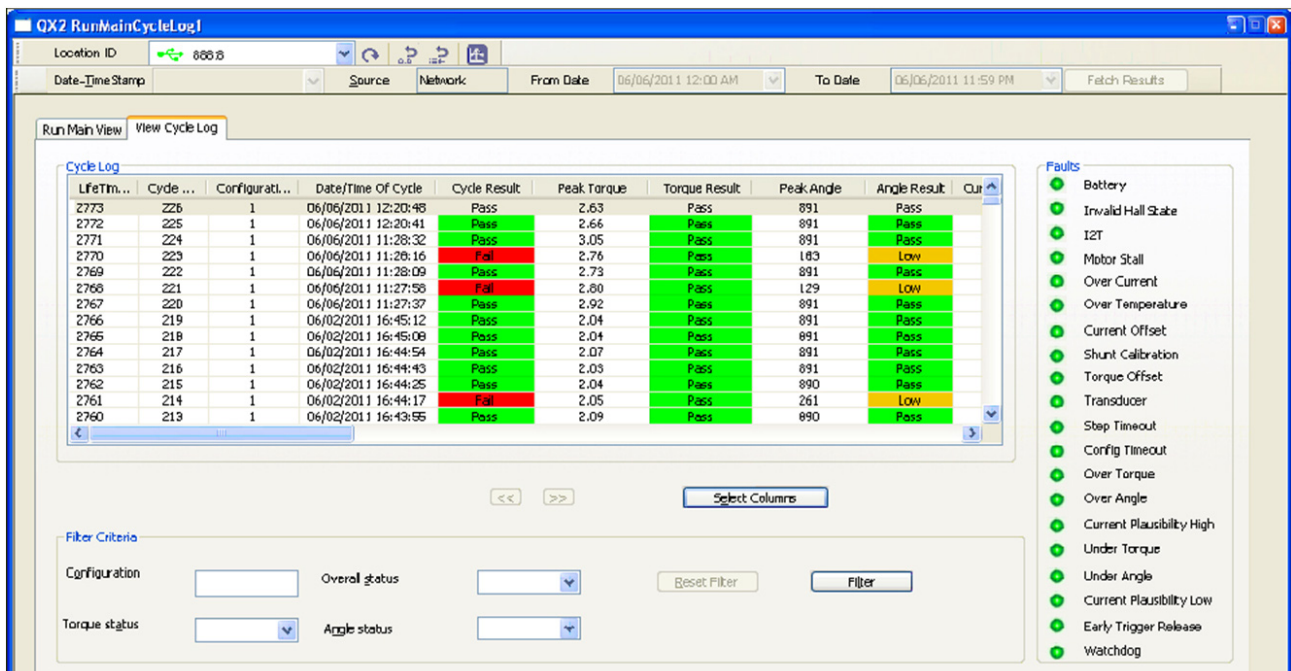

Fault group displays the fault code indicators for each of the selected cycle.

Cycle log data can be filtered using below mentioned criteria.

Configuration Number (1 to 8).

Overall status (Pass or Fail)

Torque status (Pass, High or Low)

Angle status (Pass, High or Low)

"Reset Filter" clears the filter applied to the data.

By default, the cycle log screen displays all columns. The number of columns displayed on screen can be adjusted by clicking on "Select Columns" button.

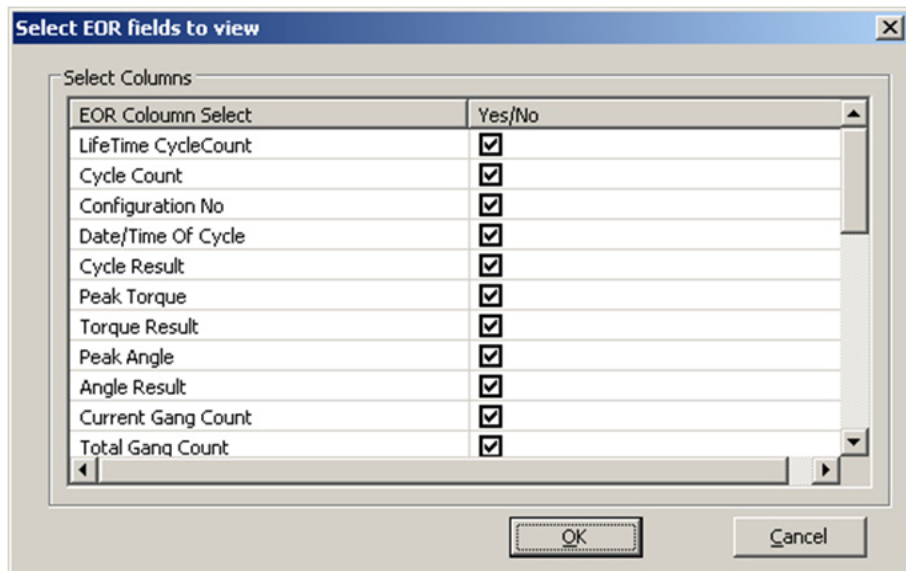

Activate the check box next to column you wish to have it displayed, when finished click on OK button.



Life Time Cycle Count	Displays total number of cycles the tool has run. User cannot reset this value.
Cycle Count	Displays total number of cycles the tool has run since last reset cycle count.
Configuration No	The Configuration Number for tightening cycle
Date/Time of Cycle	Displays Date and Time of the EOR cycle.
Cycle Result	Displays overall result (Pass / Fail).
Peak Torque	Displays peak torque reached during tightening cycle.
Torque Result	Displays result of the torque, Pass if it is within Low and High limit values, Low if peak torque is less than Low limit and High if peak torque is greater than or equal to high limit.
Peak Angle	Displays maximum angle rotated during tightening cycle.
Angle Result	Displays the result of the angle, Pass if it is within the Low and High limit values, Low if Maximum angle is less than Low limit and High if maximum angle is greater than or equal to high limit.
Current Gang Count	Displays number of similar joints that are fastened, current gang count is incremented only for passed cycle. For example, if the gang count is 3 bolts, then current gang count is reported as 1, 2, and 3 for these three EORs.
Total Gang Count	Displays total number of similar joints that are set to be fastened for configuration.
Torque Units	Displays selected units for the tightening cycle: Nm, In-lbs and Ft-lbs.
Target Value	Displays target value for Torque/Angle Control
Tightening Mode	Displays type of fastening mode (Angle and Torque)
Joint Type	Displays type of Joint (Hard and Soft)
Torque Hi Limit	Displays Torque High Limit set for configuration.
Torque Lo Limit	Displays Torque Low Limit set for configuration.
Angle Hi Limit	Displays Angle High Limit set for configuration.
Angle Lo Limit	Displays Angle Low Limit set for configuration.
Step Number	Displays Step Number of the cycle.
Motor Status	Displays Motor Status of the cycle. 'No Fault' is highlighted in Green if no fault has occurred or 'Fault' is highlighted in Red if fault has occurred.
Peak Current	Displays maximum current drawn during tightening cycle.

Following table shows the additional fields that are present in IC-PCM 1:1 tightening records

Barcode	Displays Barcode information.
Tool Serial Number	Displays factory provided identification number of the tool.
Free Speed	Displays programmed Free Speed for the configuration.
Downshift Speed	Displays programmed tool speed during shift down phase.
Max Tool Speed	Displays maximum speed of the tool.
TR	Displays Transducer Range value.

At any instance click  button to save the currently displayed data to local database with current time stamp. Click on  button to delete locally stored data with particular time stamp, confirmation message is displayed before deleting the data.

To view the latest cycle on this screen, click on  Refresh button in communication tool bar.

 Clear Cycle log button clears the cycle log present in the tool or IC-PCM 1:1.

 Reset Cycle Counter button resets the cycle count of tool.

 Launch Statistical Parameter button will open the Statistics Screen for selected set of cycles entered in the filter criteria.

4.1.2.1 Data Saved/Retrieved from PC Local Database

Once data has been retrieved from a IC-PCM 1:1/tool, it can be saved to the PC local database for later viewing and analysis. To save cycle log data to the PC, select Save from File menu. To retrieve an already saved cycle log, first click on Database button in main tool bar and then select the Location ID. The Date-Time Stamp drop box will then be populated with all saved cycle logs. Select one from this list to view it. Once this data is displayed; it can be filtered and statistics can be calculated.

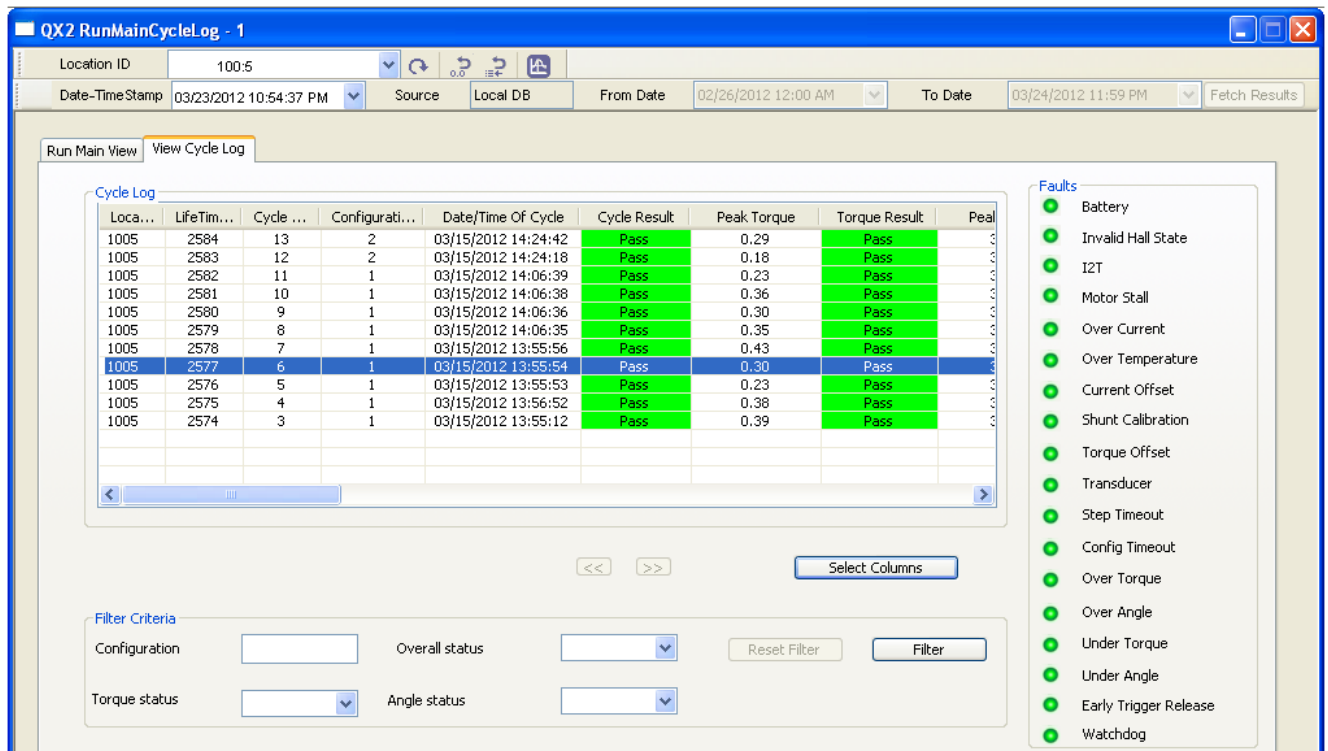

The screenshot shows the 'QX2 RunMainCycleLog - 1' application window. At the top, there are fields for 'Location ID' (100.5), 'Date-Time Stamp' (03/23/2012 10:54:37 PM), 'Source' (Local DB), 'From Date' (02/26/2012 12:00 AM), and 'To Date' (03/24/2012 11:59 PM). Below these are tabs for 'Run Main View' and 'View Cycle Log'. The 'View Cycle Log' tab is active, displaying a table with the following columns: 'Loca...', 'LifeTim...', 'Cycle ...', 'Configurati...', 'Date/Time Of Cycle', 'Cycle Result', 'Peak Torque', 'Torque Result', and 'Peal'. The table contains 14 rows of data, with the last row (1005, 2574, 3, 1, 03/15/2012 13:55:12) highlighted in blue. To the right of the table is a 'Faults' list with 14 items, each with a green circle icon: Battery, Invalid Hall State, I2T, Motor Stall, Over Current, Over Temperature, Current Offset, Shunt Calibration, Torque Offset, Transducer, Step Timeout, Config Timeout, Over Torque, Over Angle, Under Torque, Under Angle, Early Trigger Release, and Watchdog. At the bottom, there is a 'Filter Criteria' section with dropdown menus for 'Configuration', 'Overall status', 'Torque status', and 'Angle status', along with 'Reset Filter' and 'Filter' buttons.

4.1.2.2 Data retrieved from the Archived Database

Once the tool is set to archive EOR data from archival setting screen, user has an option to view the archived EOR data by clicking archival button in main tool bar. Select desired Location ID from Location ID drop box. Select required range from **From Date** and **To Date** and click on **Fetch cycles**. Cycles archived during the specified range will be displayed.

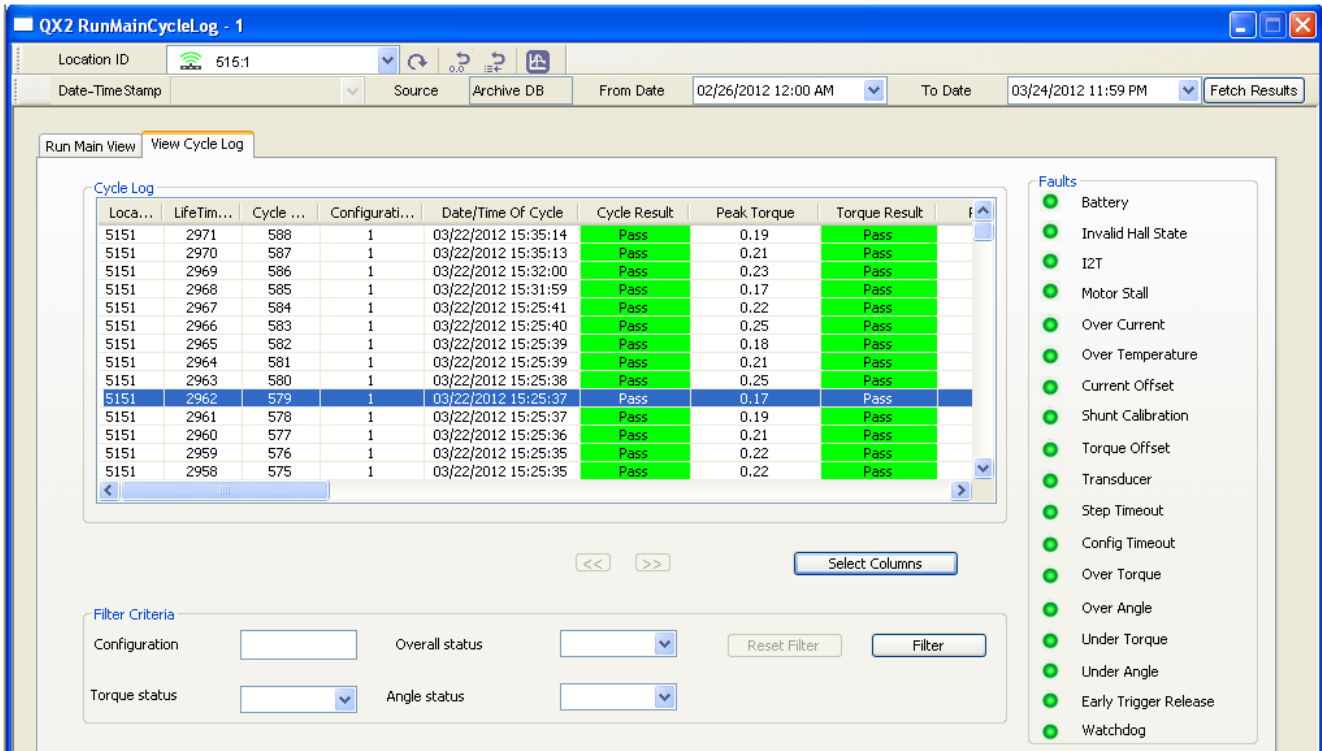

To print (default printer) or export (.csv (Comma separated value), .pdf and .rtf (rich text format)) cycle log data, select the appropriate option from the File menu.

4.2 Run Main View All

Displays the latest EOR data of all tools connected to USB / IC-PCM that are in network.

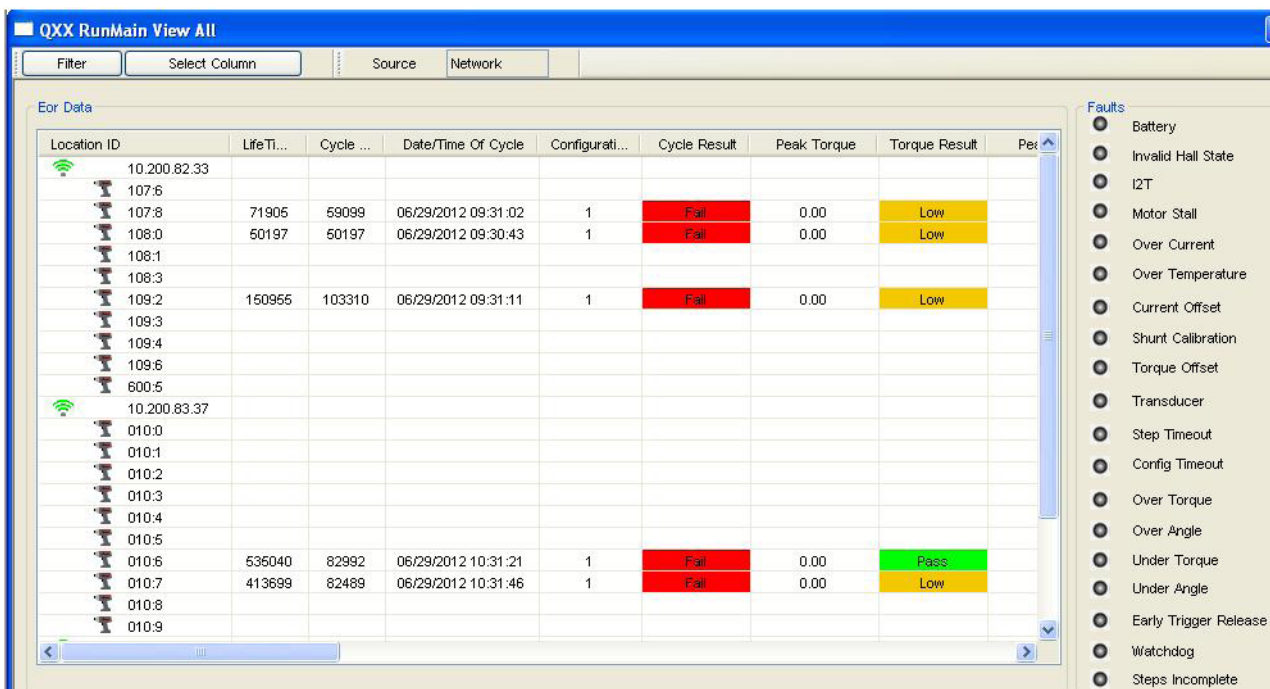

To view only a subset of available tools on the Run Main View All screen:

1. Click the Filter button to display the Select Controllers Dialog screen shown in the following Figure.

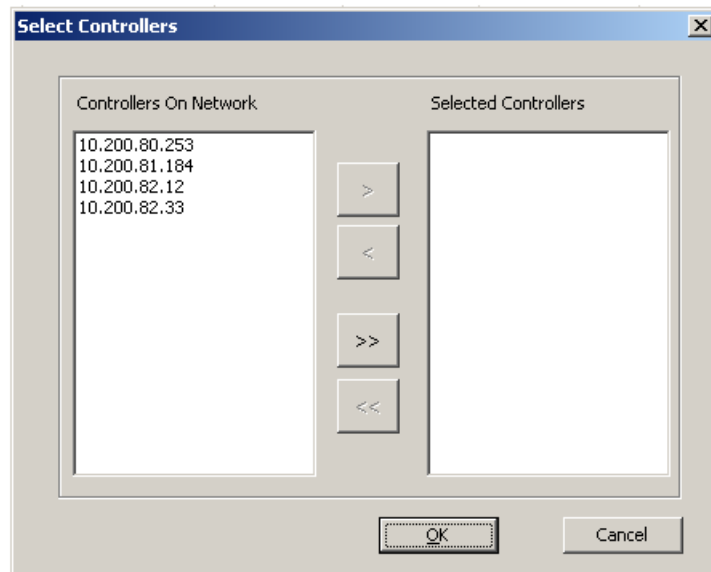

2. On the Select IC-PCM Dialog, choose IC-PCM from 'IC-PCM On Network' list box on left side of dialog, and click the right arrow (>) button to move them to the Selected IC-PCM box. Use double right arrow (>>) button to select all IC-PCM. All Tools mapped to selected IC-PCM are displayed on screen.
3. To deselect IC-PCM from the Selected IC-PCM dialog, choose IC-PCM to be removed and click the left arrow (<) button. Use the double left arrow (<<) button to deselect all.
4. Once the selection is made, click OK button to view the tools mapped to the selected IC-PCM in Run Main View All screen.

NOTE:

- Select Columns is same as cycle log screen.
- All columns are selected by default.

4.3 IC-PCM 1:1/ Tool Event Log

This screen allows user to view the event log that is recorded on the tool/ IC-PCM 1:1.

4.3.1 IC-PCM 1:1 Event Log

Select required tool mapped to IC-PCM 1:1 to view the IC-PCM 1:1 event log. The recorded event log is displayed with date and time of event, event code and description of the event. Following Figure displays the IC-PCM 1:1 event log.

Date/Time	Event Code	Description
07/11/2012 05:41:08 PM	6	General Setup Change
07/11/2012 07:56:22 PM	6	General Setup Change
07/11/2012 08:23:49 PM	6	General Setup Change
07/11/2012 08:29:35 PM	6	General Setup Change
07/11/2012 08:29:53 PM	6	General Setup Change
07/12/2012 08:20:17 PM	6	General Setup Change
07/12/2012 10:18:07 PM	6	General Setup Change
07/13/2012 12:08:23 AM	6	General Setup Change
07/13/2012 12:08:30 AM	6	General Setup Change
07/13/2012 12:08:37 AM	2	Tool Enabled
07/13/2012 12:08:37 AM	6	General Setup Change
07/13/2012 12:08:46 AM	6	General Setup Change
07/13/2012 12:08:54 AM	6	General Setup Change
07/13/2012 02:09:12 AM	6	General Setup Change
07/13/2012 02:13:33 AM	6	General Setup Change
07/13/2012 03:04:12 PM	6	General Setup Change
07/13/2012 03:04:17 PM	6	General Setup Change
07/13/2012 09:29:09 PM	6	General Setup Change

Below is the list of events that are recorded in IC-PCM 1:1 with their respective event codes;

Event Code	Event Description
0	Undefined
1	Tool Disabled
2	Tool Enabled
3	Start Diagnostic Mode
4	Stop Diagnostic Mode
5	Date-Time Set
6	General Setup Change
7	PLUS Server Connected
8	PLUS Server Disconnected
9	Unknown Server Attempted Connection
10	An incoming message contained a non-numeric first char
11	Invalid block counter
12	Unexpected message
13	Invalid message length
14	Receive Buffer is full
15	Too many messages in the receive buffer
16	Plus terminal has stopped
17	Plus is not ready to send
18	The incoming message is from a backup node
19	An unknown error string was encountered
20	An NNEG Error was received
21	An NTMU Error was received
22	An NSCR Error was received
23	An NSTR Error was received
24	The PLUS assembly timeout occurred
25	Manual reset was pressed
26	IC-PCM 1:1 received NAK-A from PFCS
27	IC-PCM 1:1 received NAK-B from PFCS
28	IC-PCM 1:1 received NAK-E from PFCS
29	IC-PCM 1:1 received NAK-H from PFCS
30	IC-PCM 1:1 received NAK-J from PFCS
31	IC-PCM 1:1 received NAK-I from PFCS
32	IC-PCM 1:1 received NAK-D from PFCS
33	IC-PCM 1:1 sending a retry
34	Printer not responding to the status request
35	Printer not responding state cleared
36	Printer Jam
37	Printer jam state cleared
38	Printer out of paper
39	Printer out of paper state cleared
40	Printer ink error
41	Printer ink error state cleared
42	Printer off line
43	Printer off line state cleared
44	Printer mechanical error

45	Printer mechanical error state cleared
46	Printer communication error
47	Printer communication error state cleared
48	Printer buffer empty
49	Printer buffer empty state cleared
50	Printer buffer overflow error
51	Printer buffer overflow error state clear
52	General Setup File Reset

4.3.2 Tool Event Log

Select the Tool connected to USB or mapped to IC-PCM 10:1 to view the tool's event log. The tool records the Fault Codes and Descriptions with date/time stamps along with motor fault codes (Status Mask).

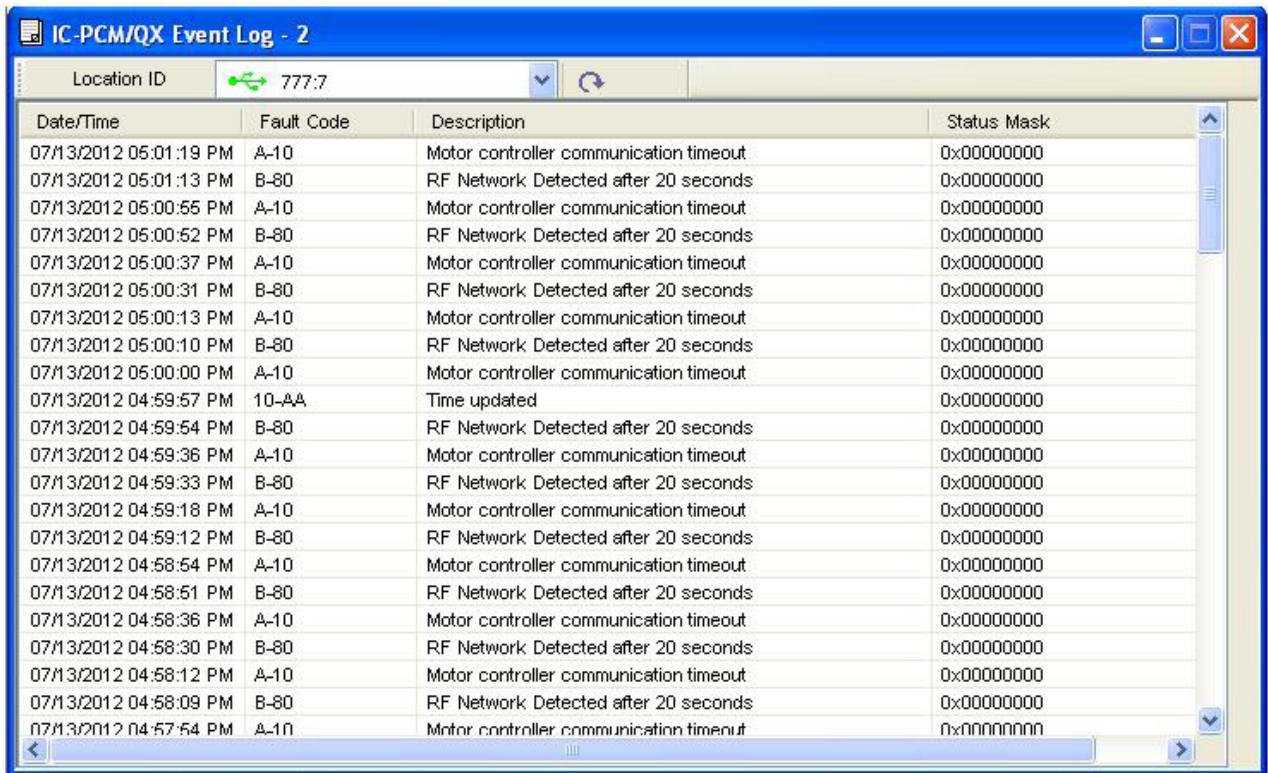

Following are the Fault Codes and their description:

Fault Code	Description
F-01	Tool Disabled (by external control)
F-02	Cycle Delay fault -- trigger was pulled before cycle delay timer expired
F-03	Tool Locked by Smart Socket Function -- user needs to select the correct socket at the PCM
1-FF	USB enumeration fault
2- <Alarm ID>	PM Alarm Time Fault for corresponding Alarm ID normally configured by the user
3- <Alarm ID>	PM Alarm Cycle Fault for corresponding Alarm ID normally configured by the user
A-10	Motor controller communication timeout
A-55	A display software version update was detected
A-AA	The display memory was re-initialized to factory defaults
B-01	Failure to update Motor Controller Software
B-50	Duplicate Tool Location ID detected
B-85	RF ACK Timeout (we did not get a serial ACK messages from the transceiver)
B-E1	RF Transmit NAK -- "Channel Access Failure"
B-E5	RF Transmit NAK -- "Frame Too Long"

B-E9	RF Transmit NAK – “No ACK Received”
C-01	Configuration ID value is 0 or greater than 8
C-02	Number of configuration steps is greater than 8
C-03	Current Step ID is greater than the current number of steps
C-04	Total Gang is greater than 8
C-05	Current Gang count is greater than Total Gang
C-06	Current Torque High Limit is greater than Tool’s maximum Torque value (Tool’s max torque value is configured in the Factory Set Points) OR Current Torque High Limit is less than 0
C-07	Current Torque Low Limit is greater than Tool’s maximum Torque value OR Current Torque Low Limit is less than 0
C-08	Current Torque High Limit is less than Current Torque Low Limit
C-09	Current Torque Low Limit is greater than Current Torque High Limit (Fault code to be removed)
C-0A	Current Angle High Limit is greater than Tool’s maximum Angle value (to be set to 9999)
C-0B	Current Angle Low Limit is greater than Tool’s maximum Angle value (to be set to 9999)
C-0C	Current Angle High Limit is less than Current Angle Low Limit
C-0D	Current Angle Low Limit is greater than Current Angle High Limit (Fault code to be removed)
C-0E	Tool configuration step is a Torque target and target value is outside torque high and low limits
C-0F	Tool configuration step is an Angle target and target value is outside angle high and low limits
C-10	Tool configuration step is not set for either Angle or Torque
C-11	Current Threshold value is greater than maximum tool torque OR Current Threshold value is less than 0
C-12	Current Free Speed is greater than maximum motor speed
C-13	Current Shiftdown Speed is greater than maximum motor speed
C-14	Current display unit value is unsupported
C-15	Current Shiftdown Point if above target or above Target (for torque strategy) or above tool’s torque limit (for angle strategy).
C-16	Number of configuration steps is set to 0
E-00	Using MC Software 1.0.1.2, Battery Fault
E-01	Using MC Software 1.0.1.2, Invalid Hall State
E-02	Using MC Software 1.0.1.2, I2T Fault
E-03	Using MC Software 1.0.1.2, Motor Stall
E-04	Using MC Software 1.0.1.2, Over Current
E-05	Using MC Software 1.0.1.2, Over Temperature
E-06	Using MC Software 1.0.1.2, Current Offset
E-07	Using MC Software 1.0.1.2, Shunt Cal
E-08	Using MC Software 1.0.1.2, Torque Offset Fault
E-09	Using MC Software 1.0.1.2, Transducer Fault
E-0A	Using MC Software 1.0.1.2, Step Execution Timeout
E-0B	Using MC Software 1.0.1.2, Configuration Execution Timeout
E-0C	Using MC Software 1.0.1.2, Over Torque Limit
E-0D	Using MC Software 1.0.1.2, Over Angle Limit
E-0E	Using MC Software 1.0.1.2, Current Plausibility High
E-0F	Using MC Software 1.0.1.2, Under Torque
E-10	Using MC Software 1.0.1.2, Under Angle
E-11	Using MC Software 1.0.1.2, Current Plausibility Low
E-12	Using MC Software 1.0.1.2, Early trigger Release
E-13	Using MC Software 1.0.1.2, Motor Controller Watchdog Reset
E-14	Using MC Software 1.0.1.2, Motor Controller Stop Timeout

E-15	Using MC Software 1.0.1.2, Motor Controller to Display EOR message failure
E-18	Using MC Software 1.0.4.2, Motor Controller did not run all steps (mainly affects Prevailing Torque)
E-1B	Using MC Software 1.0.1.2, Battery Cell Fault (detected by Motor Controller)
E-1C	Using MC Software 1.0.1.2, Low Battery Fault (detected by Motor Controller)
E-1D	Using MC Software 1.0.1.2, Critical Battery Fault (detected by Motor Controller)
E-1E	Using MC Software 1.0.1.2, Motor Controller is shutting down
E-1F	Using MC Software 1.0.1.2, Wakeup Code received (but not expected)
E-81	The configuration ID in the Motor controller's EOR did not match the currently selected configuration
10-01	Configuration Page Update from Communication interface (USB or Wireless)
10-02	Tool Locked by Communication Interface (USB or Wireless)
10-03	Tool disabled by Communication Interface (USB or Wireless)
10-04	Configuration Selected by Communication Interface (USB or Wireless)
10-05	Gang Advanced by Communication Interface (USB or Wireless)
10-06	Gang reset by Communication Interface (USB or Wireless)
10-07	Configuration advanced by Communication Interface (USB or Wireless)
10-08	Configuration Reset by Communication Interface (USB or Wireless)
10-09	SPI Memory erased by Communication Interface (USB or Wireless)
10-0A	Tool Reset by Communication Interface (USB or Wireless)
10-0B	Factory calibrations restored by Communication Interface (USB or Wireless)
10-0C	Cycle log cleared by Communication Interface (USB or Wireless)
10-0D	Event log cleared by Communication Interface (USB or Wireless)
10-AA	Time updated by Communication Interface (USB or Wireless)
20-01	Complete Tool memory reset to defaults
20-02	Tool reset configuration to Defaults
EE-E0	RF Protocol Error - RF Message Packet too small
EE-E1	RF Protocol Error - RF Packet too long

Motor Status Code description;

Bit Position	Fault Description
1	Battery
2	Invalid Hall State
3	I2T
4	Motor Stall
5	Over Current
6	Over Temperature
7	Current Offset Fault
8	Shunt Cal
9	Torque Offset Fault
10	Transducer Fault
11	Step Time Out
12	Configuration Timeout
13	Over Torque
14	Over Angle
16	Under Torque
17	Under Angle
19	Early Trigger Release
20	Watchdog
25	Missed Run Steps

4.4 Status/View Network

The Status->View Network Screen is a read only screen which provides a clear overview of all USB Tools / IC-PCM connected to the network. Information is displayed in a tree view structure.

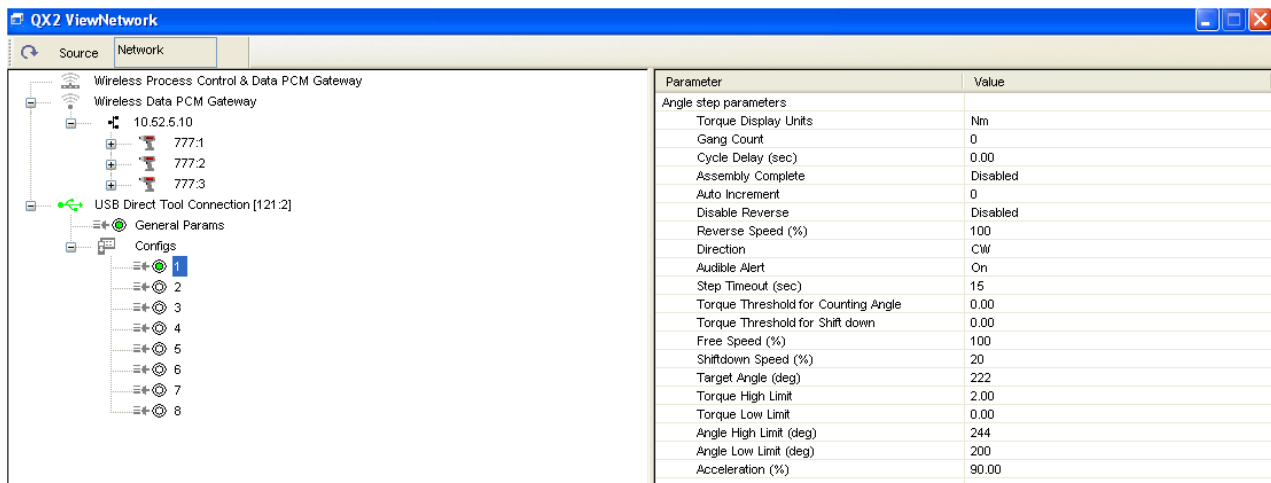

This screen contains:

4.4.1 IC-PCM 1:1

Expanding this node will list all the IC-PCM 1:1 available on the network. Expanding on a IC-PCM 1:1 node will display the IC-PCM 1:1 "General Params" node and a node for the tool that is mapped to the IC-PCM 1:1. Double clicking on the "General Params" node of the IC-PCM 1:1 will display the IC-PCM 1:1 General Parameters on the right hand side of the screen.

Expanding the mapped "Tool Location ID" node will display the "General Params" node and the "Configs" node for tool.

Expanding the "Configs" node will display a node for each of the 8 allowable Configurations.

Double clicking on a particular "Configuration Number" node will display the Configuration Parameters of the tool on the right hand side of the screen, if the Configuration is programmed (Green icon).

Double clicking on the tool's "General Params" node will display the General Parameters of the tool on the right hand side of the screen.

4.4.2 IC-PCM 10:1

Expanding this node will list all IC-PCM 10:1 available on network.

Expanding a IC-PCM 10:1 node will display all Location IDs of the tools that are mapped to IC-PCM 10:1.

Expanding a mapped "Tool Location ID" node will display the "General Params" node and the "Configs" node for tool.

Expanding the "Configs" node will display a node for each of 8 allowable Configurations.

Double clicking on a particular "Configuration Number" node will display the Configuration Parameters of tool on the right hand side of the screen, if the Configuration is programmed (Green icon).

Double clicking on a tool's "General Params" node will display the General Parameters of tool on right hand side of the screen.

4.4.3 USB Direct Tool Connection

Expanding this node will display the "General Params" node and "Configs" node for a tool connected with a USB cable.

Double clicking on the tool's "General Params" node will display General Parameters of tool on right hand side of screen.

Expanding the "Config" node will display a node for each of 8 allowable Configurations.

Double clicking on a particular "Configuration Number" node will display the Configuration Parameters of tool on right hand side of screen, if Configuration is programmed (Green icon).

4.5 Create Report

To create a specific type of report this screen can be used. The same can be exported to a file or printed to the default printer.

Create report screen contains three tabs.

1. Tool Report.
2. VIN Report.
3. Report Generator.

Tool Report and VIN Report tabs will generate reports for only EORs that are from IC-PCM 1:1. Using Report Generator tab will generate reports for both tools mapped IC-PCM.

4.5.1 Tool Report.

This report is generated based on the tool serial number as primary criteria.

Location	LifeTime	CycleCount	Cycle Count	Configuratio...	Date/Time Of Cycle	Cycle Result	Peak Torque	Torque Result	Peak Angle	Angle Result	Current C
7777	107690	95	1	1	06/29/2012 12:26:20	Pass	0.18	Pass	102	Pass	0
7777	107689	94	1	1	06/29/2012 12:26:19	Pass	0.25	Pass	102	Pass	0
7777	107688	93	1	1	06/29/2012 12:26:18	Pass	0.23	Pass	102	Pass	0
7777	107687	92	1	1	06/29/2012 12:26:18	Pass	0.19	Pass	102	Pass	0
7777	107686	91	1	1	06/29/2012 12:26:18	Pass	0.23	Pass	102	Pass	0
7777	107685	90	1	1	06/29/2012 12:26:17	Pass	0.25	Pass	102	Pass	0
7777	107684	89	1	1	06/29/2012 12:26:17	Pass	0.17	Pass	102	Pass	0
7777	107683	88	1	1	06/29/2012 12:26:17	Pass	0.22	Pass	102	Pass	0
7777	107682	87	1	1	06/29/2012 12:26:12	Pass	0.22	Pass	102	Pass	0
7777	107681	86	1	1	06/29/2012 12:26:11	Pass	0.18	Pass	102	Pass	0
7777	107680	85	1	1	06/29/2012 12:26:11	Pass	0.19	Pass	102	Pass	0

Filter criteria can be provided for Tightening Result (Pass or Fail), Angle Result (Pass, High or Low), Torque Result (Pass, High or Low) and VIN code (Vehicle Identification Number/Code, also called as Barcode). Date and Time Criteria should be provided, and records within the From/To Date and Time will be displayed.

4.5.2 VIN Report

This report is generated based on the VIN (Vehicle Identification Number).

Location ID	LifeTime	CycleCount	Cycle Count	Configuratio...	Date/Time Of Cycle	Cycle Result	Peak Torque	Torque Result	Peak Angle	Angle Result	Current C
7777	107686	91	1	1	06/29/2012 12:26:18	Pass	0.23	Pass	102	Pass	0
7777	107686	90	1	1	06/29/2012 12:26:17	Pass	0.25	Pass	102	Pass	0
7777	107684	89	1	1	06/29/2012 12:26:17	Pass	0.17	Pass	102	Pass	0
7777	107683	88	1	1	06/29/2012 12:26:17	Pass	0.22	Pass	102	Pass	0
7777	107682	87	1	1	06/29/2012 12:26:12	Pass	0.22	Pass	102	Pass	0
7777	107681	86	1	1	06/29/2012 12:26:11	Pass	0.18	Pass	102	Pass	0
7777	107680	85	1	1	06/29/2012 12:26:11	Pass	0.19	Pass	102	Pass	0
7777	107679	84	1	1	06/29/2012 12:26:10	Pass	0.25	Pass	102	Pass	0
7777	107678	83	1	1	06/29/2012 12:26:10	Pass	0.21	Pass	102	Pass	0
7777	107677	82	1	1	06/29/2012 12:26:09	Pass	0.23	Pass	102	Pass	0
7777	107676	81	1	1	06/29/2012 12:26:09	Pass	0.19	Pass	102	Pass	0
7777	107675	80	1	1	06/29/2012 12:26:08	Pass	0.18	Pass	102	Pass	0

Filter criteria can be provided for Tightening Result (Pass or Fail), Angle Result (Pass, High or Low), Torque Result (Pass, High or Low) and Tool serial number. Date and Time Criteria should be provided, and records within the From/To Date and Time will be displayed.

4.5.3 Report Generator

Report generator can be used to have multiple criteria for report generation. Provide Filter criteria in "From" and "To" column and check "Enable Filter" check box to enable particular filter.

The screenshot shows the 'Report Generator' interface with the following data in the filter table:

EOR Field	From	To	Enable Filter
Peak Torque			<input type="checkbox"/>
Torque Result			<input type="checkbox"/>
Peak Angle	200	300	<input checked="" type="checkbox"/>
Angle Result			<input type="checkbox"/>
Current Gang Count			<input type="checkbox"/>
Total Gang Count			<input type="checkbox"/>
Torque Units			<input type="checkbox"/>
Target Value			<input type="checkbox"/>
Tightening Mode			<input type="checkbox"/>
Joint Type			<input type="checkbox"/>

Location ID	LifeTime CycleCount	Cycle Count	Date/Time Of Cycle	Configuration No	Cycle Result	Peak Torque	Torque Result	Peak Angle	Angle Result	Current
3333	18176	300	03/22/2012 04:58:25	1	Fail	0.26	Pass	233	Low	0
3333	18173	297	03/22/2012 04:58:24	1	Fail	0.35	Pass	245	Low	0
3333	18154	278	03/22/2012 04:54:46	1	Fail	0.40	Pass	276	Low	0
5151	2774	391	03/21/2012 17:35:02	1	Fail	0.18	Pass	300	Low	0
5151	2773	390	03/21/2012 17:35:01	1	Fail	0.18	Pass	298	Low	0
5151	2771	388	03/21/2012 17:35:00	1	Fail	0.29	Pass	236	Low	0
5151	2772	389	03/21/2012 17:35:00	1	Fail	0.18	Pass	293	Low	0
5151	2770	387	03/21/2012 17:34:54	1	Fail	0.19	Pass	269	Low	0
5151	2766	383	03/21/2012 17:34:33	1	Fail	0.23	Pass	277	Low	0
5151	2767	384	03/21/2012 17:34:33	1	Fail	0.22	Pass	238	Low	0
5151	2749	366	03/21/2012 17:34:04	1	Fail	0.23	Pass	274	Low	0
5151	2748	365	03/21/2012 17:33:32	1	Fail	0.25	Pass	221	Low	0
5151	2742	359	03/21/2012 17:33:29	1	Fail	0.21	Pass	226	Low	0
5151	2737	354	03/21/2012 17:33:26	1	Fail	0.26	Pass	225	Low	0
5151	2728	345	03/21/2012 17:33:22	1	Fail	0.23	Pass	239	Low	0
5151	2729	346	03/21/2012 17:33:22	1	Fail	0.18	Pass	214	Low	0
5151	2727	344	03/21/2012 17:33:21	1	Fail	0.22	Pass	226	Low	0

Section 5 – Archiving Data

5.1 Archival Settings Screen

The Archiving feature allows the storing EOR, configurations and general settings of tools that are mapped to IC-PCM and also archives IC-PCM 1:1 General Settings.

Archiving is only available for MultiSync and Enterprise versions of ICS software installed with SQL database option. A master license can be used to set and view the archival setting, and is needed to archive data. A slave license can be used to view Archival settings and view archived data.

The Archival Settings screen is enabled only when ICS is installed with SQL server as the Database option.

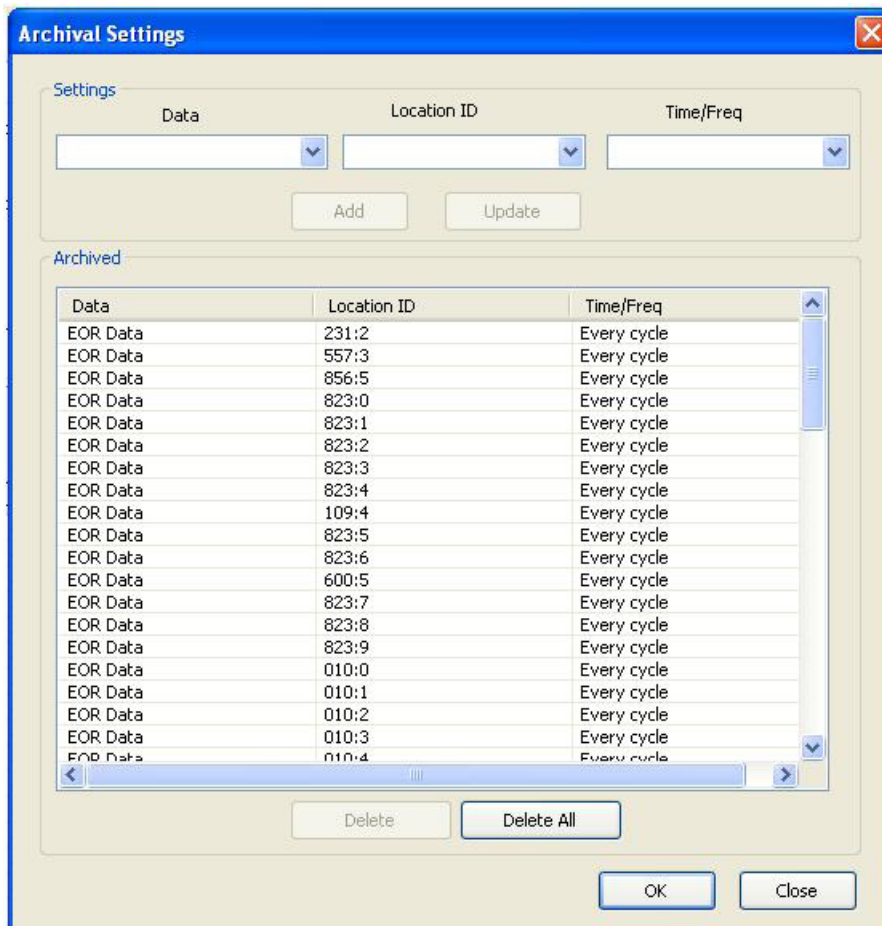

Data	The Data Dropdown list has three items as mentioned below: EOR Data – EOR Data can be archived for a tool connected to a IC-PCM Parameters (IC-PCM 1:1 General Setup) – Parameters of IC-PCM 1:1 General Setup can be archived for each IC-PCM 1:1 on Network. Parameters (Config and General) – Configurations and General Parameter settings of a tool connected to a IC-PCM can be archived.
Location ID	Location ID Dropdown list will display all tools connected to IC-PCM.
Time/Freq	Time/Freq dropdown list displays options for how often the data will be archived.
Add	Add button is used to add the location ID and Data that is to be archived to list.
Update	Update button is used to modify Archival settings and update changes for selected Location ID.
Delete	Delete button is used to delete the selected Location ID from the Archival list.
Delete All	Delete All button is used to delete all the existing Location IDs from the Archival list.
OK/Cancel	OK button is used to save the changes and Cancel button is used to exit without saving the changes.

Section 6 – Quality Control

6.1 Statistics

The Statistics Summary screen displays the statistics computed from the cycle log data for the selected tool and Configuration. The screen displays Population and Sample Statistical data for both torque and angle results.

The statistical data can be saved to the local database by selecting Save from the File menu.

Population Statistics			Sample Statistics		
Parameter	Torque	Angle	Parameter	Torque	Angle
Strategy	Torque Control		Strategy	Torque Control	
Target	0.00		Target	0.00	
X-Bar	0.00	0.00	X-Bar	0.00	0.00
Range	0.00	0.00	Range	0.00	0.00
Meanshift	0.00	0.00	Meanshift	0.00	0.00
Capability	0.00	0.00	Capability	0.00	0.00
CAM	0.00	0.00	CAM	0.00	0.00
Sigma	0.00	0.00	Sigma	0.00	0.00
# for Sigma	0	0	# for Sigma	0	0
PP	0.00	0.00	PP	0.00	0.00
PPK	0.00	0.00	PPK	0.00	0.00

The Statistics Summary screen allows the user to select the tool Location ID and Configuration number. Internally ICS fetches the cycle log data, calculates, and displays both Population and Sample Statistics for the selected configuration number.

The Statistics Summary screen displays the following parameters and their values for Population & Sample Statistics for both Torque and Angle results:

Strategy - Selected Strategy

Target - Target Torque/Angle

X-Bar - Mean

Range - Max Value - Min Value

Mean Shift - Mean - Target

Capability - This is calculated as $(6 * \text{sigma} / \text{Mean}) * 100$

CAM - $(\text{Upper Limit} - \text{Lower Limit}) / (6 * (W/dS))$

Where W - Average dispersion, $dS = 1.746$

Sigma - Standard Deviation

PP - Capability Statistics parameter calculated as $(\text{Upper set limit} - \text{Lower set limit}) / (6 * \text{sigma})$

PPK - Capability Statistics parameters calculated as $\text{Min}((\text{mean} - \text{Lower set limit}) / (3 * \text{sigma}) \text{ or } (\text{Upper set limit} - \text{mean}) / (3 * \text{sigma}))$

The size of the Sample Statistics size can be set by clicking the Set Parameters button on the Tool Bar. This displays the Set Statistics Parameters box. This box has a Sample Size entry field for setting the number of readings to be used for computing Sample Statistics. The Sample Size is 25 by default.

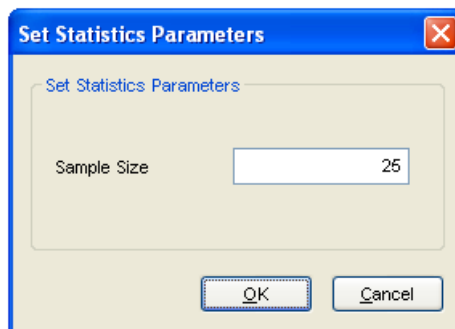

The Statistics Summary screen can also be launched from the RunMain Cycle Log screen. After selecting a Configuration and highlighting the desired Cycle Log results, click the Launch Statistical Parameters button. The Statistics Summary screen will be launched with only the Population Statistics displayed.

NOTE: A minimum of three cycle log records have to be selected to calculate the statistics.

6.1.1 Statistical Data Saved/Retrieved from Local Database

Statistical data can be saved to the PC's Local Database for later viewing and analysis. To save the Statistical data to the PC, select Save from the File menu or use the Save icon from the main tool bar. To retrieve an already saved Statistical data set, first click on the Database Mode button in the main tool bar. Next, select the tool Location ID and corresponding Config number. Select the desired set from the Date/Time Stamp drop box.

Section 7 – System Diagnostics

The System Diagnostics screen allows you to check the overall system status of the tool Connected to USB. This functionality also assists in diagnosing tool problems, calibrating the tool and also sets the Preventive Maintenance Alarms.

The PM alarm and tool status functionalities are also applicable for the tools connected to IC-PCM

1. Tool Test.
2. Tool Status.
3. Keypad Status (contains LED and Speaker diagnostics).
4. Tool Calibration.
5. PM Alarm (Preventive Maintenance).

7.1 Tool Test

The Tool Test tab allows viewing the tool readings for the selected Location ID. Proceeding with this shall put the tool in diagnostic mode. The tool is put into Diagnostic mode, but normal operation is not suspended. It is recommended that user does not perform normal operations (tightening) when tool is in diagnostic mode. When the too trigger is pulled the currently selected configuration will be run. The user can read the following values on the screen while the tool is running:

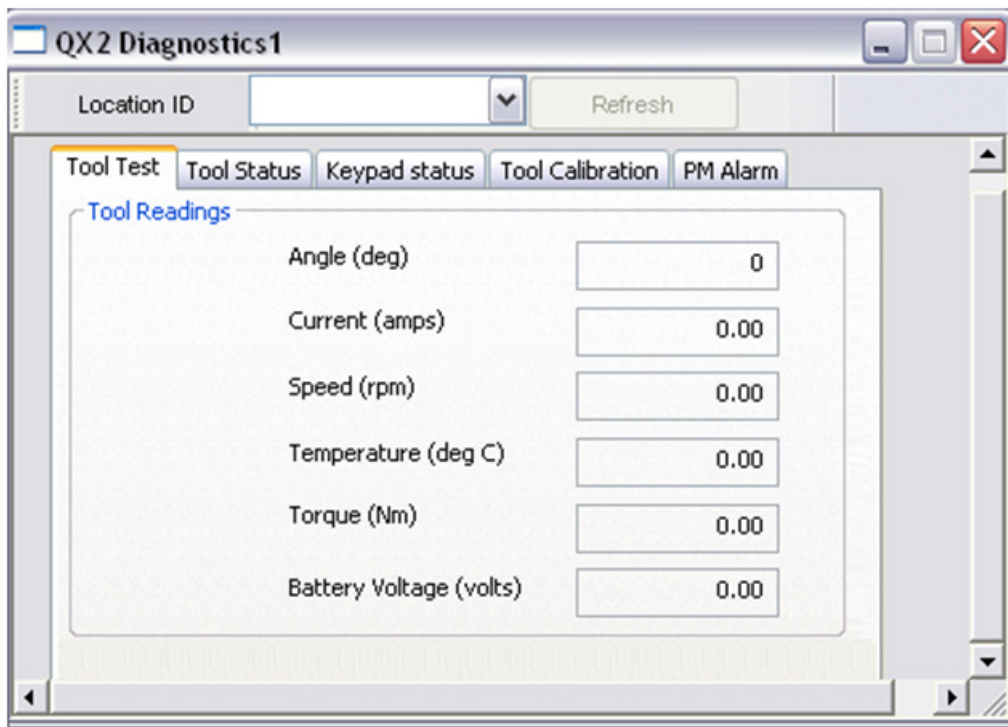





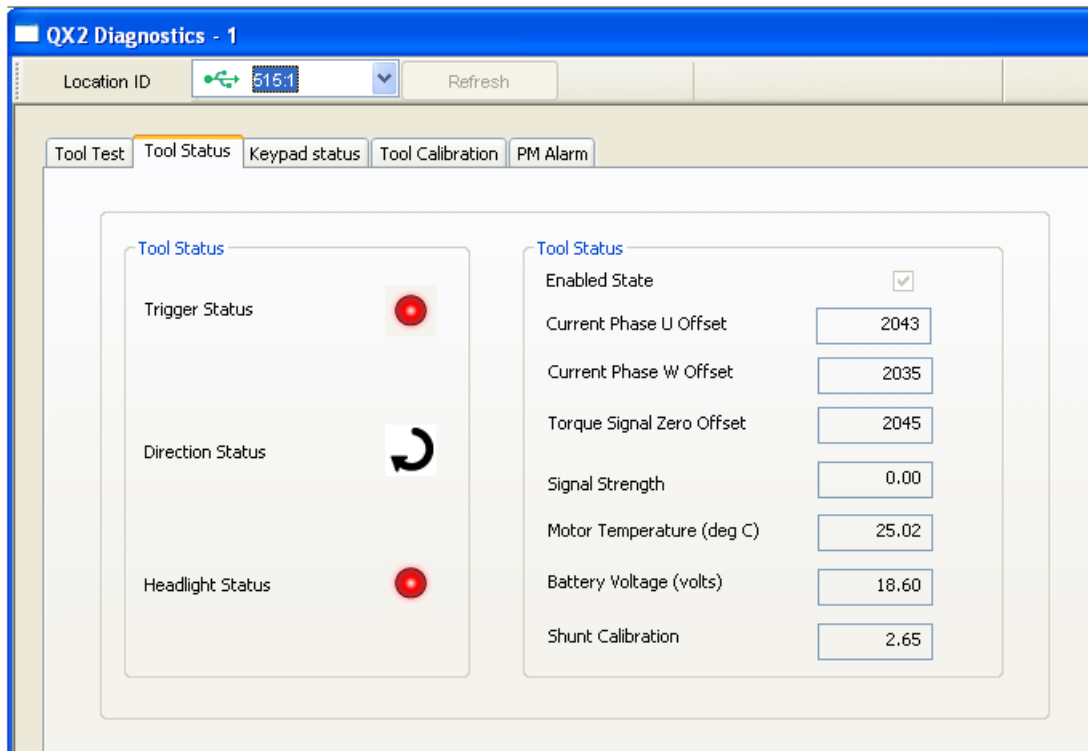

Angle	Degrees of Rotation.
Current	Current drawn in amps.
Speed	Rotational speed in RPM.
Temperature	Measured temperature of the tool in degree Celsius.
Torque	Dynamic Torque achieved.
Battery Voltage	Current Battery Voltage of the tool.

7.2 Tool Status

Tool Status tab displays system data for diagnostics purpose.



Tool Status Tab displays the following Tool Status;

Trigger State	Displays Pulled/Released status of trigger switch. (Pulled  Released )
Direction State	Displays CW/CCW status of direction switch. (CW  CCW )
Headlight Status	Displays ON/OFF Status of Headlight LED. (On  Off )
Enabled state	Displays whether tool can perform the tightening operation. If checked tool can perform the tightening operation, if configuration selected is valid.
Current Phase U offset	Displays Current Phase U offset status of motor.
Current Phase W offset	Displays Current Phase W offset status of motor.
Torque Signal Zero Offset	Displays status of Torque Signal Zero Offset.
Signal Strength	Displays Wireless signal strength
Motor Temperature	Displays motor temperature of tool.
Battery Voltage	Displays Current Battery Voltage in Volts.
Shunt Calibration	Displays value of Shunt Calibration.

7.3 Keypad, LED and Audio Diagnostics

This screen can be used to diagnose status of Keypad, Led and Speaker of tool.

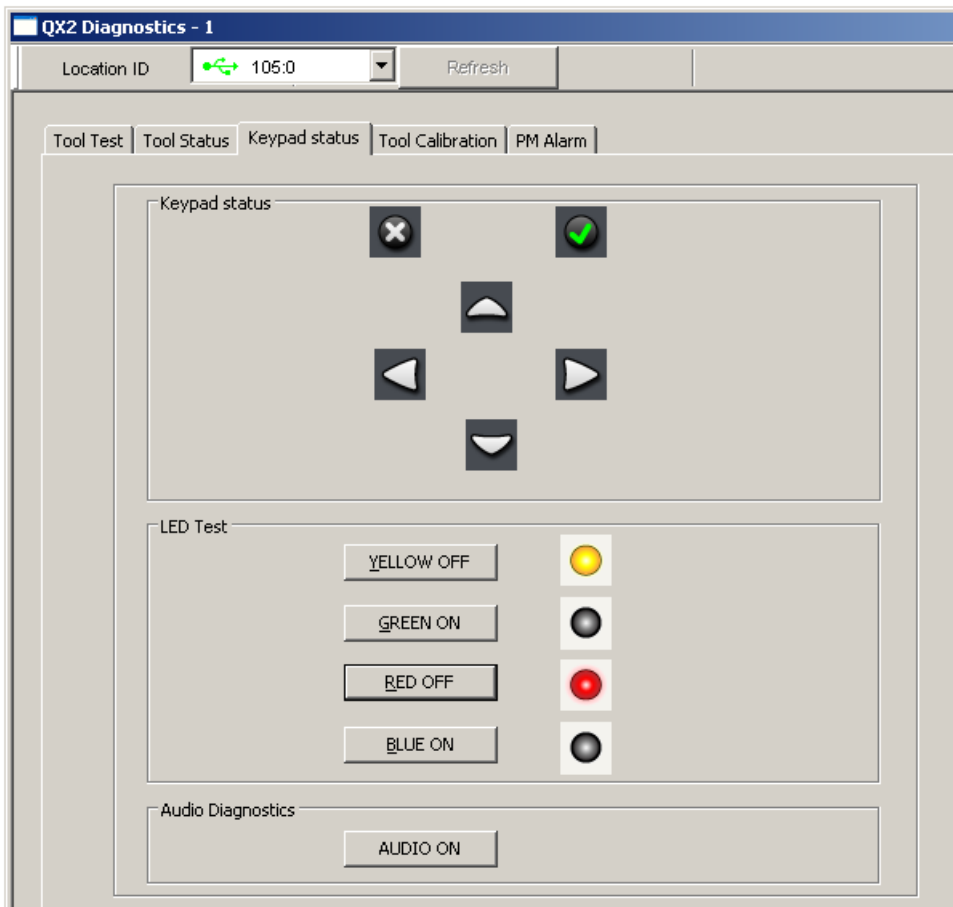

7.3.1 Keypad Status

Displays the current status of keys.

Sl no.	Key	Pressed	Released
1	Up		
2	Down		
3	Right		
4	Left		
5	Esc		
6	Enter		

7.3.2 LED Test

Displays the current status of the LEDs and also can switch on or off particular LED by clicking on the particular LED button.

Sl no.	Key	Pressed	Released
1	Yellow		
2	Green		
3	Red		
4	Blue		

7.3.3 Audio Diagnostics

Click on "AUDIO ON" button to turn on the beep sound to test the speaker in the tool. This sound will remain for 5 seconds.

7.4 Tool Calibration

The tool calibration screen allows user to calibrate selected tool's TR. It allows to SET/RESET the values for TR, ASC and KT. Also it allows to send Gearbox Loss percentage value to tool.

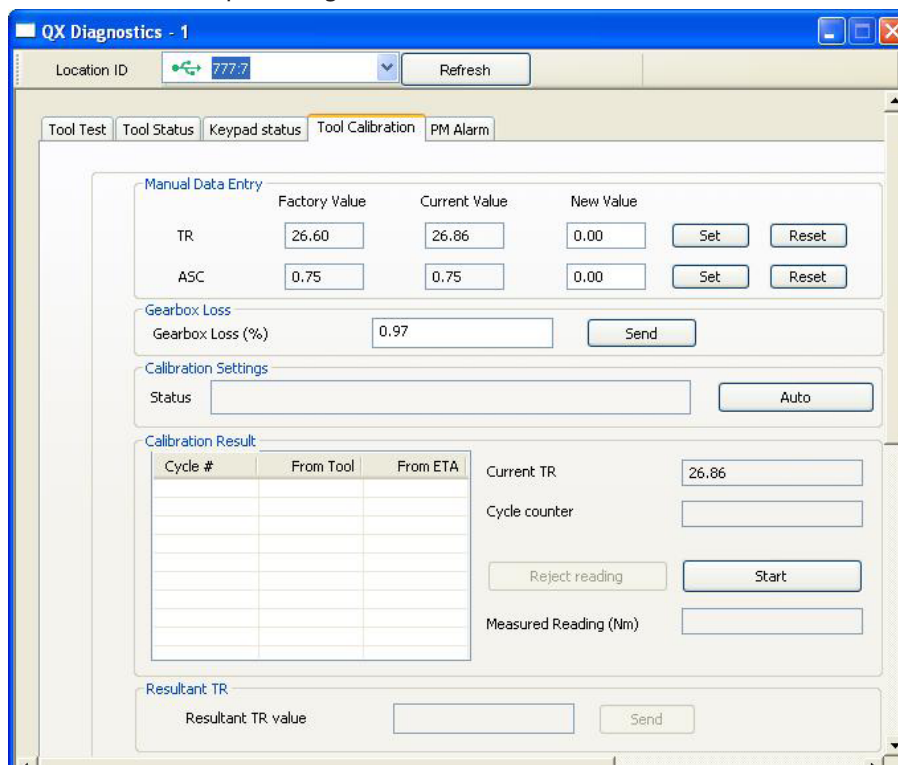

Manual Data Entry

User can Set/Reset TR, ASC, KT values to tool, it also displays Factory & Current values for TR, ASC and KT. User can enter TR & ASC value $\pm 20\%$ of the factory value of TR and ASC.

By default User TR & User ASC is set to Factory setting value of ASC and TR.

User can enter the KT sensitivity value between 0.01 and 1.00, by default it is set to 1.00.

Gearbox Loss %

The user can enter a value of $\pm 40\%$ in the Gearbox Loss data box. When this value is sent to the tool the TR value of the tool will change according to the following: $\text{User_TR} = \text{Factory_TR} - [\text{Gear_box_Percentage} * \text{Factory_TR} / 100]$

Calibration Settings

There are two types of calibration modes: Auto and Manual.

This screen allows Auto calibration to run, which can calibrate the Transducer Range (TR) for the tool using an **Ingersoll Rand** ETA5 series Torque Analyzer or an **Ingersoll Rand** EXT Series Torque Analyzer.

Upon receiving the EOR record from the tool, the torque value is displayed in the list. The ICS software then reads the ETA5/EXT torque value measured for the active cycle number and displays the received value in the ETA5 Torque column.

Click the Reject Reading button to reject any individual run throughout calibration procedure.

The new TR value is calculated when the STOP is pressed. The new TR value is displayed as Resultant TR Value. The Resultant TR Value can be set to the tool using send button.

New TRs are calculated after each tightening. Rejecting any reading results in recalculation of the resultant TR.

In case of manual mode calibration Click Auto button to change to manual mode. In manual mode, user should enter the measured value read from some external torque monitoring device.

User can Print or Save an Auto calibration report via the File menu.

7.5 PM Alarms

PM Alarms are reminders for regular tool preventative maintenance. The PM Alarms section helps user keep track of the preventative maintenance schedule for tool. Up to five different alarms can be set with duration as "number of cycles" or "Number of Days".

The Preventive Maintenance (PM) Alarm screen displays all PM alarms set on tool and allows editing settings. In addition, this screen allows resetting any PM alarm.

The screen shows Alarm, the Duration, the Start Count/Set Date, and Expiration Count/Date for each alarm. Use the Reset button to reset start and expiration count/date.

Disable Tool checkbox feature allows to disable tool when the alarm is triggered.

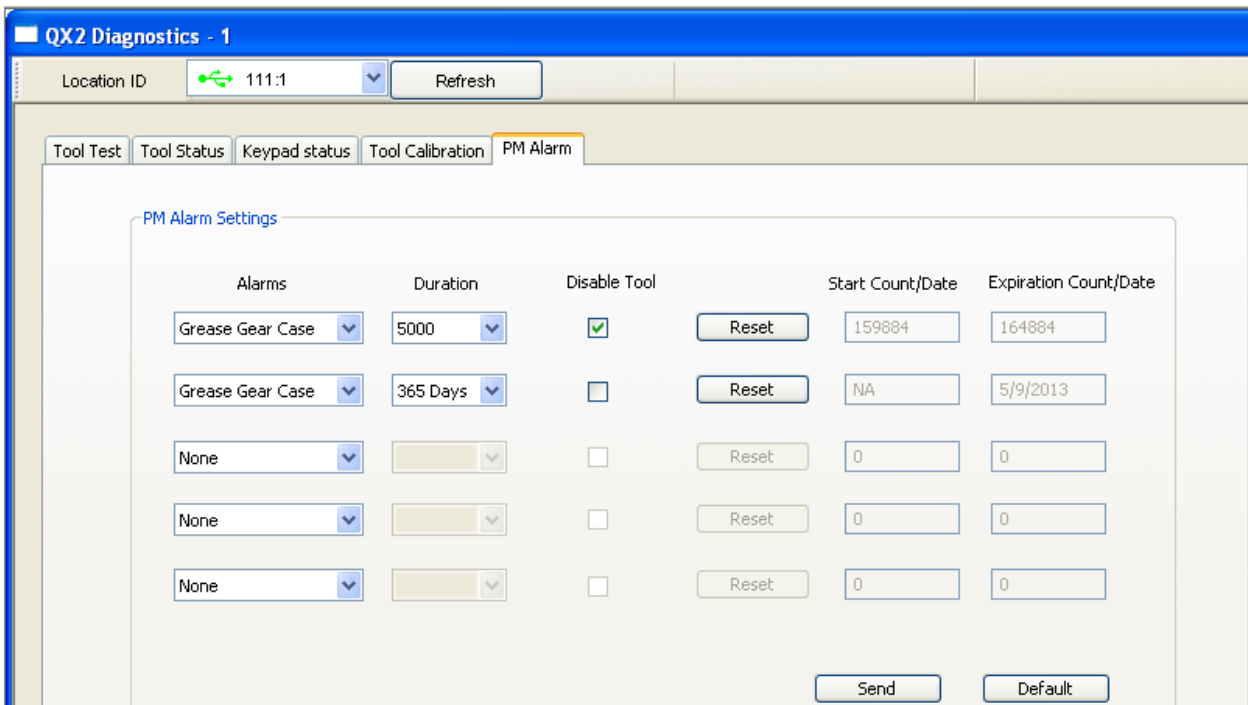

The Alarm can be set for following items;

- Grease Gear case
- Grease Angle head
- Grease Offset head
- Grease Tube nut head
- Check Tool calibration

Following are the duration (cycles) for setting up the alarm;

- 5000
- 10000
- 20000
- 50000
- 100000
- 500000
- 1000000

If Wireless is enabled in the tool following are the additional option available for duration.

Days

- 1
- 5
- 7
- 14
- 30
- 90
- 180
- 270
- 365

NOTE: In case duration is set to "Number of days", upon refreshing screen, ICS can only display end date not "number of days" and "Start Date" as NA.

Alarms	Duration	Disable Tool	Start Count/Date	Expiration Count/Date
Grease Gear Case	5000	<input type="checkbox"/>	159884	164884
Grease Gear Case	5000	<input type="checkbox"/>	NA	5/9/2013
None	5000	<input type="checkbox"/>	0	0
None	5000	<input type="checkbox"/>	0	0
None	5000	<input type="checkbox"/>	0	0

7.6 System Diagnostics – View Inputs

View Inputs screen displays dynamic status of all input pins for selected IC-PCM 1:1. This screen is useful for troubleshooting an I/O problem.

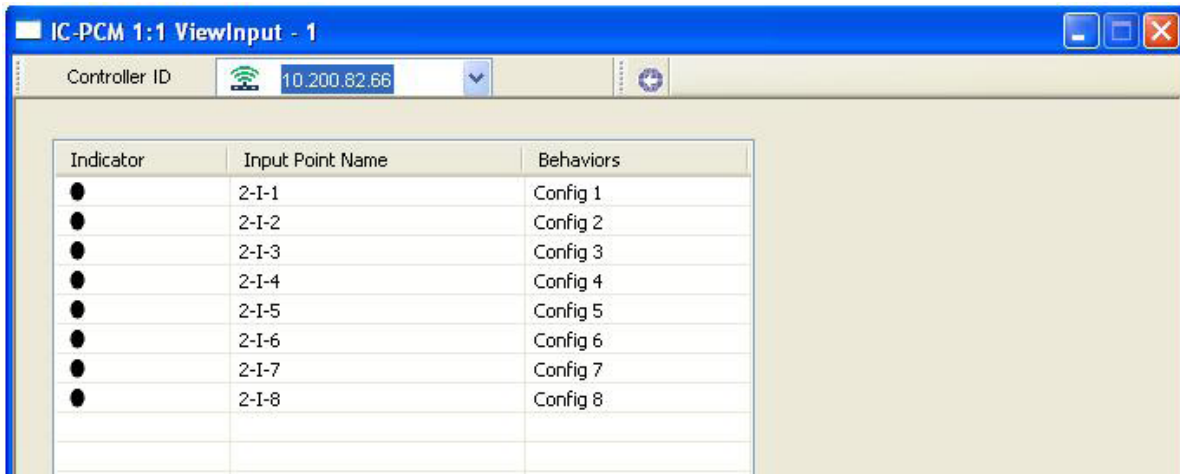

View input screen displays the selected IC-PCM 1:1 8 input pins and respective behaviours assigned to each pin.

To change the current behaviors assigned to each input pin, user has to click on  button. PCM General Setup dialog box opens up for changing the current behaviors by navigating to Assign Inputs tab of the PCM General Setup.

NOTE: The modified behaviors will be applicable only after IC-PCM 1:1 reboots.

The status of Active input pin is indicated via a virtual Green LED .

The status of inactive input pin is indicated via LED .

7.7 System Diagnostics – View/Set Output

7.7.1 View Outputs Mode (Normal Mode)

Set/View Output screen displays the dynamic status of all Output pins for the selected IC-PCM 1:1. This screen lets user manually activate an output signal for system diagnosis purpose.

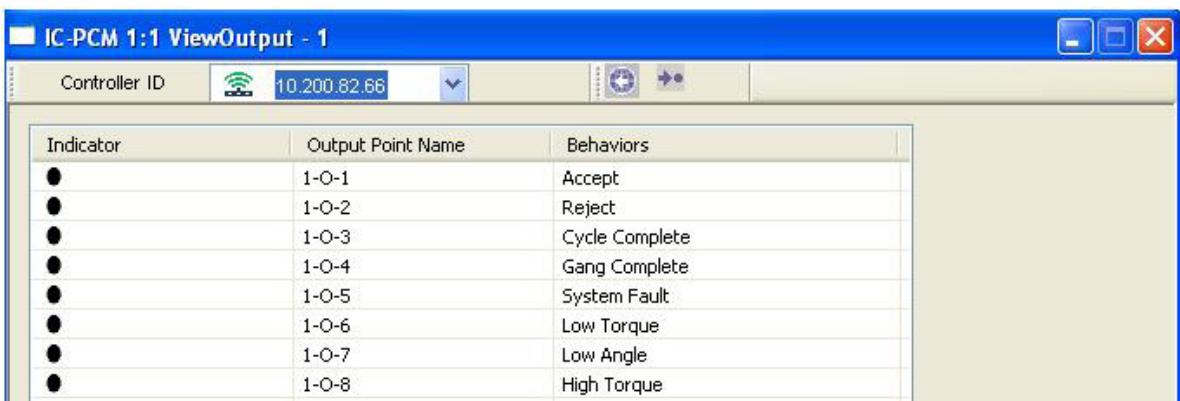

To change the current behaviors assigned to each output pin, user has to click on  button.

PCM General Setup dialog box opens and user can change the behaviors by navigating to Assign Outputs tab of the PCM General Setup. The modified behaviors will be applicable after PCM reboots.

The status of Active input pin is indicated via a virtual Green LED .

The status of inactive input pin is indicated via  LED.

Use this button  to change from Normal mode to Diagnostic mode. This will put the IC-PCM 1:1 in diagnostic mode.

7.7.2 Set Outputs Mode (Diagnostic Mode)

Set Outputs mode, screen displays dynamic status of all output pins and provides a means to set manually status of the outputs for selected IC-PCM 1:1 by sending 24v output signal to the respective pins.

The status of each output is indicated by virtual LEDs.

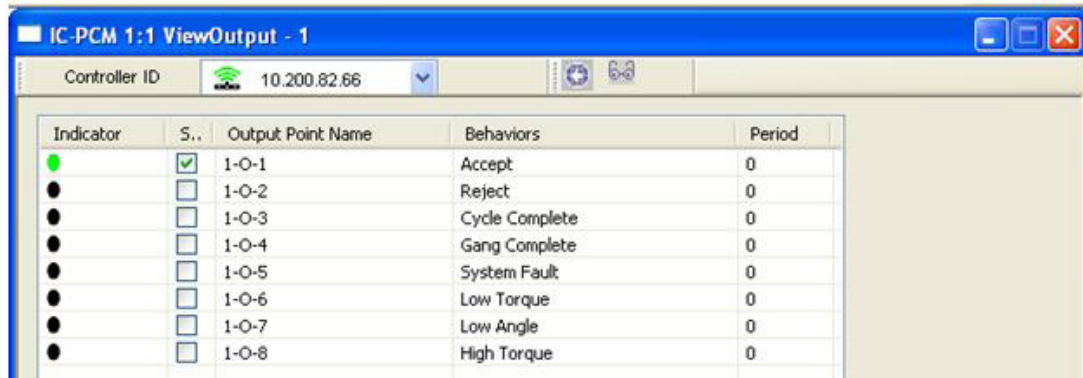

In Diagnostic mode an output can be forced by sending output. When an output signal is forced, normal operation of the system is interrupted. When the user leaves “Set Outputs” screen, the forced signals on to the respective output pins will be reset to normal.

The status of Active output pin when “output signal is forced” is shown via Virtual green LED ●.

User can switch to Normal Mode (View Mode) by clicking on .

NOTE: Forcing outputs will disable and enable normal tool operation.

Care should be taken to ensure the work area is safe prior to manually activating outputs. Ensure that devices attached to the IC-PCM 1:1’s outputs will not create a hazardous condition if outputs are manually activated.

7.8 Direct Controller Discovery

This screen is used for direct discovery of the IC-PCM. If the user wants to discover only certain IC-PCM, check the “Disable Discovery” check box.

Enter the IP Address for the selected device of interest.

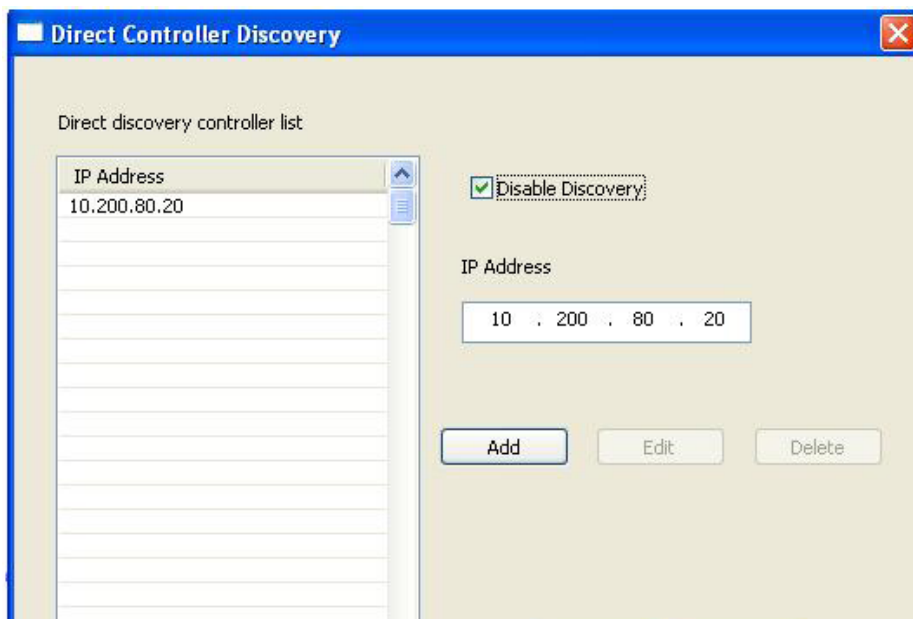

NOTE: If disable discovery check box is not checked, ICS discovers all the IC-PCM available in the network.

Section 8 – Wireless Diagnostics

Displays wireless statistics of tool connected to USB or IC-PCM also displays wireless statistics of IC-PCM for diagnostic purpose.

8.1 Wireless statistics of USB Connected Tool

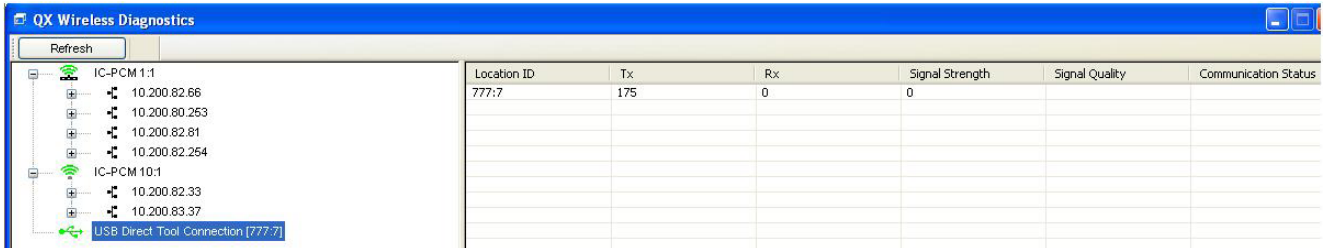

The screenshot shows the 'QX Wireless Diagnostics' window with a 'Refresh' button at the top left. The interface is divided into two main sections. On the left, there is a tree view showing network connections: 'IC-PCM 1:1' (with four sub-items: 10.200.82.66, 10.200.80.253, 10.200.82.81, 10.200.82.254), 'IC-PCM 10:1' (with two sub-items: 10.200.82.33, 10.200.83.37), and 'USB Direct Tool Connection [777:7]' (highlighted in blue). On the right, a table displays wireless statistics for the selected connection.

Location ID	Tx	Rx	Signal Strength	Signal Quality	Communication Status
777:7	175	0	0		

Displays the Location ID, Transmitted Packet Count, Received Packet Count and Signal Strength.

8.2 Wireless Statistics of the IC-PCM

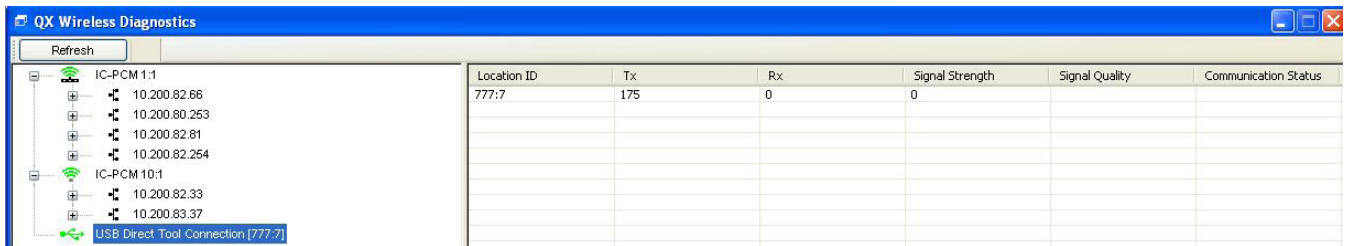

The screenshot shows the 'QX Wireless Diagnostics' window with a 'Refresh' button at the top left. The interface is divided into two main sections. On the left, there is a tree view showing network connections: 'IC-PCM 1:1' (with four sub-items: 10.200.82.66, 10.200.80.253, 10.200.82.81, 10.200.82.254), 'IC-PCM 10:1' (with two sub-items: 10.200.82.33, 10.200.83.37), and 'USB Direct Tool Connection [777:7]' (highlighted in blue). On the right, a table displays wireless statistics for the selected connection.

Location ID	Tx	Rx	Signal Strength	Signal Quality	Communication Status
777:7	175	0	0		

Displays Location ID, number of packets received and transmitted Signal Strength, Signal Quality and Communication Status of IC-PCM with wireless module.

Section 9 – General Screen Layout

9.1 ICS Screen Components

The ICS software program window consists of the following components:

- Title Bar
- Menu Bar
- Main Tool Bar
- Work Space
- Message Window
- Communication Tool Bar
- Status Bar

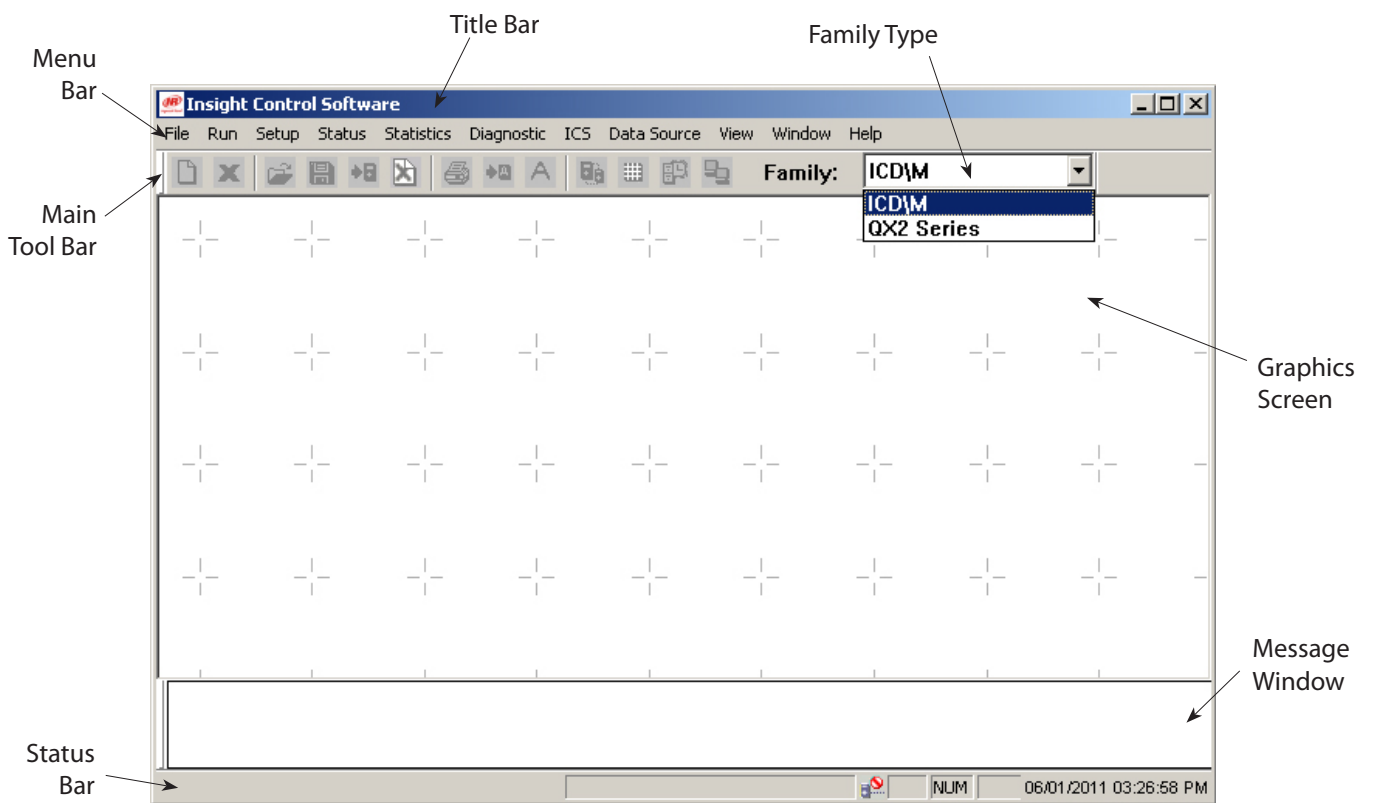

9.1.1 Title Bar

The title bar contains ICS icon and ICS name. In addition, there are standard Windows Close, Minimize, and Restore buttons. You can move the program window by clicking and dragging title bar.

9.1.2 Selection of Family Type

ICS is designed to provide a programming interface and archiving function to extend the functionality of family type IC12D/M controllers and QX Series of tools.

NOTE: Based on family type selection, contents under menus will change.

9.1.3 Menu Bar

The **Menu Bar** contain the following menus;

9.1.3.1 File Menu

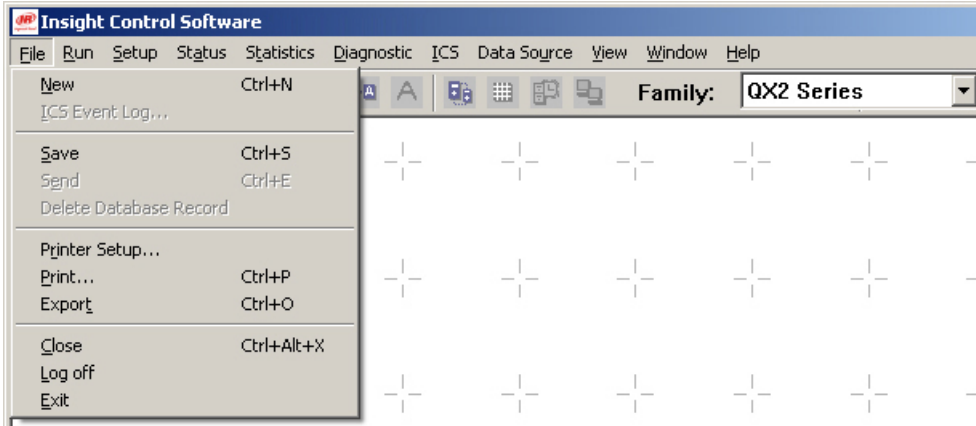

The **File Menu** is similar to the menu found on many Windows programs. It has the following options:

New	Opens a new instance of currently active window. This button will be greyed out for all single instance windows.
ICS Event Log...	Provides an option to open a previously saved ICS Event Log. It is only active when View Event Log screen is opened.
Save	Saves data of current active window to local Database.
Send	Sends parameters in current active window to selected tool or controller.
Delete Database Record	Deletes selected local database record.
Printer Setup	Opens a dialog box that allows user to set printer options.
Print	Prints the data of current active window.
Export	Exports data of current active window to a “.pdf” or “.csv” file.
Close	Closes current active window.
Log Off	Logs off current user and prompts with login window.
Exit	Closes ICS program.

9.1.3.2 Run Menu

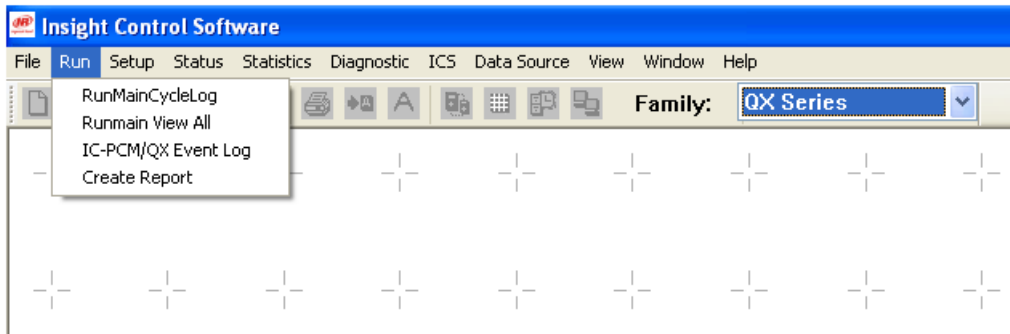

The **Run Menu** gives you access to the ICS control screen, providing the following options:

Runmain Cycle Log	Contains Run Main View and View Cycle Log
Run Main View	Displays EOR data for last cycle for a single tool connected to USB/IC-PCM.
View Cycle Log	Displays set of tightening results that are stored in tool/IC-PCM.
Runmain View All	Displays last EOR data for all tools that are connected via USB, IC-PCM.
IC-PCM/QX Event log	Displays event log of IC-PCM and QX tool
Create Report	Creates a report of EOR's based upon various criteria.

9.1.3.3 Setup Menu

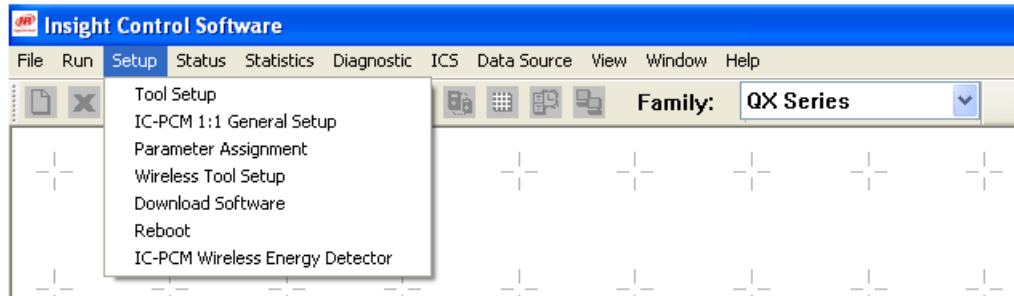

The **Setup Menu** contains all ICS settings. It contains the following options:

Tool Setup	Contains Tightening Configuration and General Setup
Tightening Configuration	Provides options to set up Torque/Angle/Prevailing Torque Strategy.
General Setup	Provides options to set up general fastening settings. (Tool Setup, Wireless Setup and Password settings)
IC-PCM 1:1 General Setup	Provides you with ability to load, view, edit, create, and save general settings for specified IC-PCM 1:1.
Parameter Assignment	Provides options to assign any saved configuration and/or general parameter set to any QX tool connected to USB or IC-PCM, and can also assign general parameter set to IC-PCM 1:1
Wireless Tool Setup	Provides options to view, setup and adjust all Location and Ethernet parameters for all IC-PCM. Also, provides options to view, setup and modify wireless settings.
Download Software	Provides options to download MCE/Display/Wireless Radio Firmware for tool connected to USB, and RISC/Wireless radio firmware to selected IC-PCM which are currently on the network.
Reboot	Provides options to reboot selected IC-PCMs and individual radio modules present in an IC-PCM
IC-PCM Wireless energy detector	Provides options to scan the energy level of all channels (11-25)

9.1.3.4 Status Menu



The **Status Menu** allows you to access the **View Network** screen.

View Network	The View Network screen provides a clear overview of all QX tools connected to USB/ IC-PCM available on the network.
---------------------	--

9.1.3.5 Statistics Menu

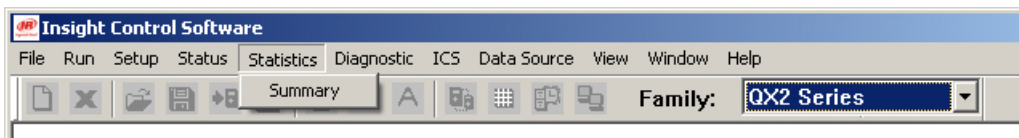

The **Statistics Menu** allows you to access the **Summary** screen.

Summary	Provides the ability to view the calculated statistics of tool cycle log data connected to USB/ IC-PCM
----------------	--

9.1.3.6 Diagnostic Menu

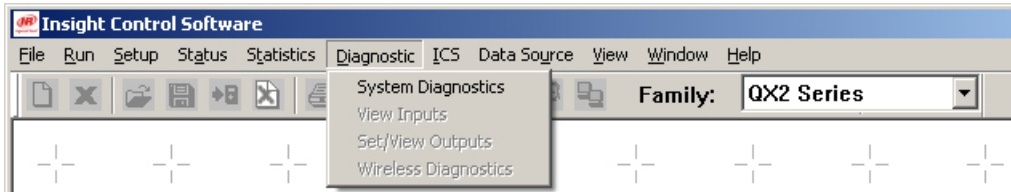

The **Diagnostic Menu** contains options for diagnostics and troubleshooting.

System Diagnostics	Tool Diagnostics is the dynamic test of tool functions for the tool connected to USB.
Tool Test	Displays diagnostics data by streaming live motor data.
Tool Status	Displays status of trigger switch, direction switch, head light and current system status.
Keypad Status	Displays current status of Keypad and LED, and perform LED test.
Tool Calibration	Allows to run calibration, which can calibrate Transducer Range (TR).
PM Alarms	Allows to get/set PM alarm settings of tool.
View Inputs	Allows viewing of input pin status of the IC-PCM 1:1
Set/View Outputs	Allows to Set and view output pin status of IC-PCM.
Wireless Diagnostics	Provides status used to diagnose the system based on different statistical values (TX, RX etc)

9.1.3.7 ICS Menu

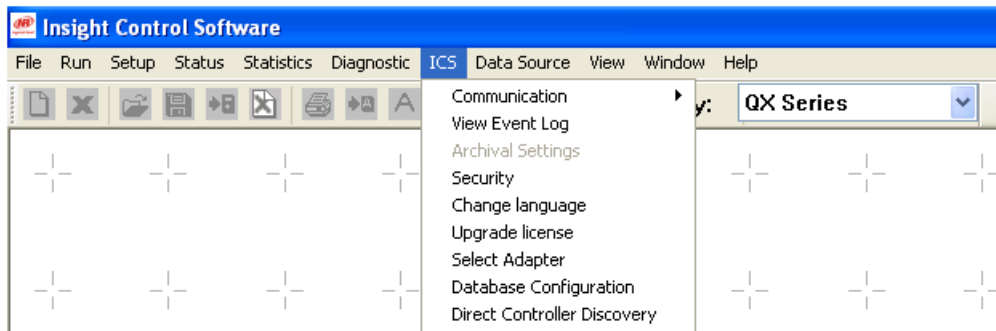

The ICS Menu provides access to eight different options, most of which allow you to perform administrative functions such as security and general system settings:

Communication	Allows setting Serial Settings & Protocol Assignments.
View Event Log	Opens ICS Event Log, which displays a log of ICS activity.
Archival Settings	Opens Archival Settings screen, which allows user to set up tools and specific data (EOR or Parameters) that require archiving.
Security	Opens Password Setup screen, which allows, with Supervisor access, user to set password and group permissions.
Change Language	Opens Select Language screen, which allows language being used in ICS to be changed. Available languages: Chinese, Czech, English, French, German, Italian, Polish, Portuguese, Russian, and Spanish.
Upgrade License	Opens Upgrade License screen, which allows user to upgrade License file.
Select Adapter	Opens Select Adapter screen, which allows selection of Network Connection type being used by ICS for connection with IC-PCM.
Database Configuration	Opens Database Configuration screen, which allows user to modify Archive Database configuration.
Direct Controller Discovery	Opens Direct Controller Discovery screen, which allows user to enter IC-PCM IP Addresses for direct discovery by ICS.

9.1.3.8 Data Source Menu

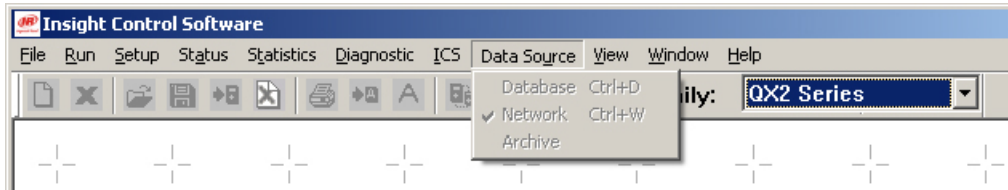

The **Data Source Menu** allows you to choose the ICS mode of operation: **Database**, **Network**, or **Archive**.

Database	When checked, indicates user is operating in Local Database Mode.
Network	When checked, indicates user is operating in Network Mode.
Archive	When checked, indicates user is operating in Archive Database Mode.

9.1.3.9 View Menu

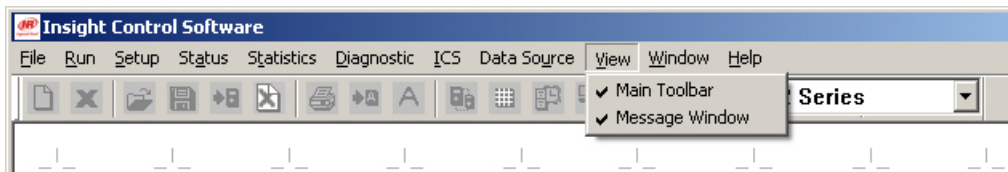

The **View Menu** allows you to toggle on and off the display of the **Main Toolbar** and the **Message Window**.

Main Toolbar	When checked, Main Toolbar will be active. When unchecked, Main Toolbar will be hidden.
Message window	When checked, Message Window will be active. When unchecked, Message Window will be hidden.

9.1.3.10 Window Menu

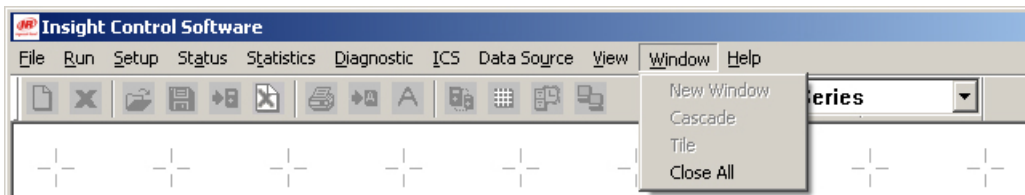

The **Window Menu** functions either to open a new window or arrange the windows displayed.

New window	When selected, a new instance of the active window is opened.
Cascade	When selected, all active windows will be arranged in a cascaded manner.
Tile	When selected, all active windows will be arranged in a tiled manner.
Close All	When selected, all active windows will be closed.

9.1.3.11 Help Menu

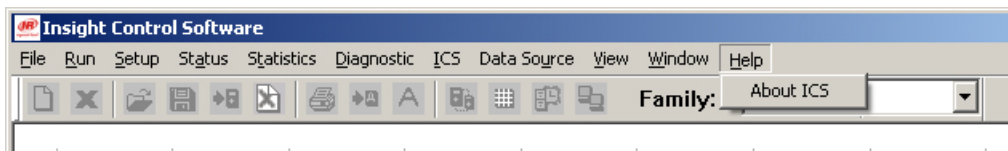

The **Help Menu** provides access to the version and license information.

About ICS	When selected, opens a window containing the software version number, copyright information and license information.
------------------	--

9.1.4 Main Tool Bar

The **Main Toolbar** is located at top of screen below menu bar.



New		Opens a new instance of currently active window. This button will be greyed out for all single instance windows.
Close		Closes current active window.
Load		Only active when viewing the ICS event log screen, this button opens a window that allows loading previously saved ICS Event Logs.
Save		Saves data of current active window to local Database.
Send		Sends the parameters in current active window to selected tool or controller.
Delete		Deletes selected local database record.
Print		Prints data of current active window.
Export		Exports the data of current active window to a ".pdf" or ".csv"
Archive Settings		Opens Archival Settings screen.
Network Mode		This button allows switching current active window to Network mode. In this mode data can be sent and received directly To/From a selected tool or a controller.
Local DB Mode		This button allows switching current active window to Local DB mode. In this mode the data can be saved to local database.
Archive Mode		This button allows switching current active window to Archive DB mode. In this mode the data which is stored in the Archived database can be viewed.
Family		There are two ICS families: ICD/M and QX Series.

9.1.5 Communication Tool Bar

The **Communication Toolbar** is primarily used to select a controller when working in Network mode. It is located at the top of the graphics screen (window). Depending on the screen type, some of the controls below may not be present.

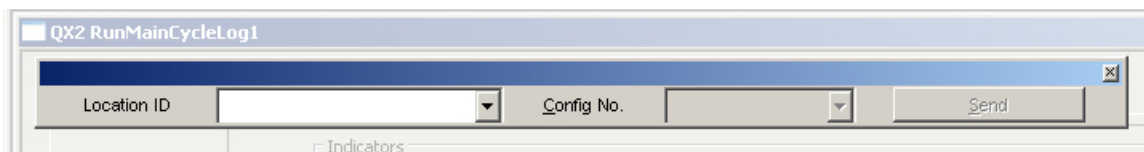

This tool bar contains the following elements:

Location Id	This drop box displays all tool connected to USB/ IC-PCM by the ICS software. From this drop box, select the desired tool.
--------------------	--

9.1.6 Database Tool Bar

The **Database Tool Bar** is primarily used to perform the DB operations, such as saving and fetching the stored data.

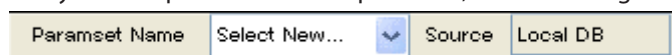

9.1.7 Work Space

The Work Space functions has a desktop for all graphics screens. All graphics screen open within the working area.

9.1.8 Graphics Screens

The graphics screens contain data and setup parameters for one or more controllers. Each screen can be individually minimized, maximized or closed. The title bar of each screen contains the screen name. The example below shows the **Tool Setup** screen open in the Work Area.

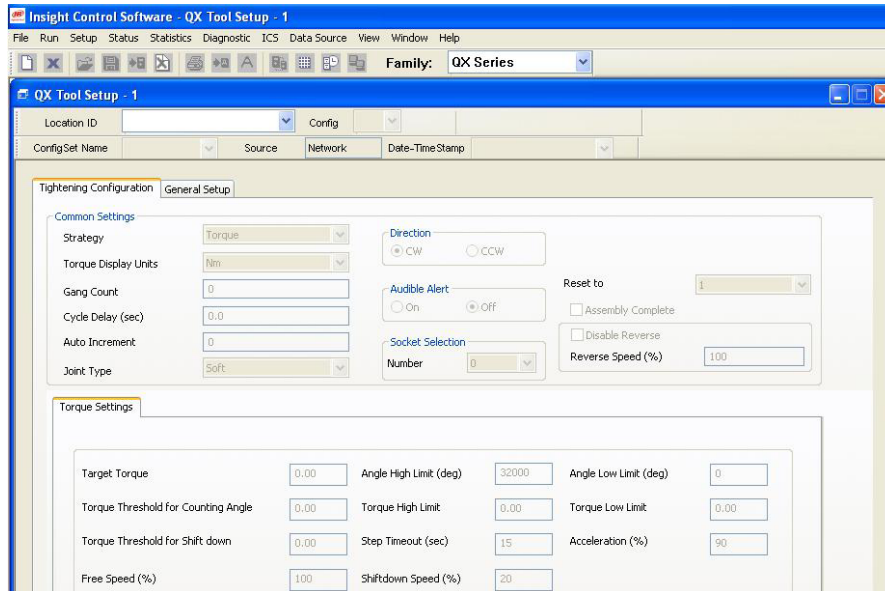

9.1.9 Status and Progress Bar

The Status bar will show a small icon for wireless tools that will have a Green Tick mark when tools are connected. Double clicking on this icon displays the Wireless Tool Settings screen.

9.1.10 Icons

There are different Icons used to represent tools connected to USB, IC-PCM.

Icons	Descriptions
	Tool Connected to USB
	IC-PCM 1:1
	IC-PCM 10:1
	Pistol type Tool connected to IC-PCM
	Tool Mapped but not connected to IC-PCM 1:1
	Tool Mapped but not connected to IC-PCM 10:1

Contact Information

Fastening Solutions

Joining components in today's industrial environment is much more than putting wrench to bolt. It's about finding a solution that links the operator and the joint and delivers unparalleled accuracy and repeatability. **Ingersoll Rand** has a superior knowledge of the threaded fastening process, acquired through years of application work with the world's leading manufacturers in the motor vehicle, aerospace, appliance, and electronics industries. We understand the interface of the tool and operator - and know how to leverage the power of ergonomically-designed equipment to maximize productivity.

Beyond just product, **Ingersoll Rand's** extensive Consulting, Integration, and Service capabilities help you before, during, and after your line or work area is configured for production. Contact **Ingersoll Rand** at the website, telephone numbers, or addresses below for a solution that will meet your needs and exceed your expectations.

Global Contact Information

Worldwide

www.ingersollrandproducts.com

North America

Ingersoll Rand

North American Solutions Center
1872 Enterprise Drive
Rochester Hills, MI 48309
Telephone: 866-284-5509

Europe

Ingersoll Rand

Swan Lane, Hindley Green
Wigan WN2 4EZ
UK

Telephone: +44 (0)1942 25 7171

Ingersoll Rand

Zone du Chene Sorcier
BP 62
78346 Les Clayes sous Bois Cedex
France
Telephone: +33 (0) 1 30 07 69 00

China

Ingersoll Rand

11F Xu Huiyuan Building, 1089 Zhong Shan Nan Er Rd.
Shanghai 200030, PRC
Telephone: +86 (0)21-54529898

India

Ingersoll Rand Wadco Tools, Ltd.

37A, Site 4
Sahibabad Industrial Area
Ghaziabad 201 010 (UP)
India
Telephone: +91 (0)120-4389200

Notes:

Notes:

Notes:

www.ingersollrandproducts.com
© 2012 **Ingersoll-Rand**, plc

